

# VECTOR

PREMIUM QUALITY  
FILTERS



## DAEWOO

FILTER SUB-CATALOGUE



# Table of Contents

Engine Application .....  
Technical Specification .....

<b>A</b>
<b>B</b>

# Engine Application

A

MODEL/APPLICATION	SAKURA NO	MODEL/APPLICATION	SAKURA NO	MODEL/APPLICATION	SAKURA NO
<b>DAEWOO</b>		<b>DAEWOO</b>		<b>DAEWOO</b>	
<b>1340XL</b> (LOADERS) YANMAR 4TNE84		Air Filter Secondary.....	A-6008	<b>DH210W/V</b> (EXCAVATORS)	
Fuel Filter.....	F-5210	Air Filter Set.....	A-5663-S	Hydraulic Oil Filter.....	H-2704
<b>170 5 SERIES</b> (LOADERS) 170 5 SERIES		Hydraulic Oil Filter.....	H-89030	<b>DH220ED</b> (EXCAVATORS)	
Air Filter Secondary.....	A-5635	<b>DH130-II</b> (EXCAVATORS)		Air Filter Primary.....	A-7954
Fuel/Water Separator.....	SFC-5705	Air Filter Primary.....	A-5627	Fuel Filter.....	F-2601
Hydraulic Oil Filter.....	H-7923	Air Filter Secondary.....	A-6008	Fuel Filter.....	F-2621
<b>170 5 SERIES</b> (LOADERS)		Air Filter Set.....	A-5663-S	Fuel Filter.....	F-2622
Air Filter Primary.....	A-5639	Hydraulic Oil Filter.....	H-2704	Hydraulic Oil Filter.....	H-2704
Air Filter Secondary.....	A-5635	<b>DH130W</b> (EXCAVATORS)		Oil Filter Full Flow.....	C-8901
Air Filter Set.....	A-5654-S	Air Filter Primary.....	A-5627	<b>DH220LC</b> (EXCAVATORS)	
Fuel/Water Separator.....	SFC-5705	Air Filter Secondary.....	A-6008	Air Filter Primary.....	A-5627
Hydraulic Oil Filter.....	H-7911	Air Filter Set.....	A-5663-S	Air Filter Primary.....	AS-1024
Oil Filter Full Flow.....	C-5611	Hydraulic Oil Filter.....	H-2704	Air Filter Secondary.....	A-6009
<b>300LC-V</b> (EXCAVATORS) DAEWOO DE12T		<b>DH170</b> (EXCAVATORS) PERKINS 1006-6 6HR		Air Filter Set.....	A-5663-S
Air Filter Secondary.....	A-89060	Air Filter Primary.....	A-5627	Air Filter Set.....	AS-1024-S
<b>340LC-V</b> (EXCAVATORS) DAEWOO DE12TIS		Air Filter Secondary.....	A-6008	Fuel Filter.....	F-2601
Air Filter Secondary.....	A-89060	Air Filter Set.....	A-5663-S	Fuel Filter.....	F-2621
<b>450</b> (LOADERS) CUMMINS B3.3 , 2004-UP		Fuel Filter.....	FC-5103	Fuel Filter.....	F-2622
Air Filter.....	A-76410	Hydraulic Oil Filter.....	H-2704	Hydraulic Oil Filter.....	H-2704
Air Filter Secondary.....	A-8599	Oil Filter Full Flow.....	C-5102	<b>DH280</b> (EXCAVATORS) DAEWOO D2366	
Air Filter Set.....	A-76410-S	<b>DH180LC</b> (EXCAVATORS) RENAULTV D0846 HM		Air Filter Primary.....	A-2210
<b>450 PLUS</b> (LOADERS) CUMMINS B3.3 , 2004-UP		Air Filter Primary.....	AS-1024	Fuel Filter.....	F-2603
Oil Filter Full Flow.....	C-56191	Air Filter Secondary.....	A-6009	Fuel Filter.....	F-2604
<b>460</b> (LOADERS) CUMMINS B3.3 , 2004-UP		Air Filter Set.....	AS-1024-S	Hydraulic Oil Filter.....	H-2704
Air Filter Primary.....	AS-9231	Hydraulic Oil Filter.....	H-2704	Hydraulic Oil Filter.....	H-89030
Air Filter Secondary.....	A-5016	<b>DH150LC-7</b> (EXCAVATORS) DAEWOO DB58TIS		Oil Filter Full Flow.....	C-7942
Air Filter Set.....	AS-9231-S	Hydraulic Oil Filter.....	H-89030	<b>DH280ED</b> (EXCAVATORS)	
<b>460</b> (LOADERS) CUMMINS B3.3 , 2004		<b>DH150W-7</b> (EXCAVATORS) DAEWOO DB58TIS		Air Filter Secondary.....	A-7619
Air Filter Secondary.....	A-5016	Hydraulic Oil Filter.....	H-89030	Fuel Filter.....	F-2603
<b>470 PLUS</b> (LOADERS) CUMMINS B3.3T , 2004-UP		<b>DH200LC</b> (EXCAVATORS) RENAULTV D0846 HM		Fuel Filter.....	F-2604
Oil Filter Full Flow.....	C-56191	Air Filter Primary.....	AS-1024	Hydraulic Oil Filter.....	H-2704
<b>D40S</b> (FORKLIFTS) PERKINS , 1995-UP		Air Filter Secondary.....	A-6009	Oil Filter Full Flow.....	C-7942
Air Filter Primary.....	A-5537	Air Filter Set.....	AS-1024-S	<b>DH220</b> (EXCAVATORS)	
Air Filter Secondary.....	A-5536	Fuel Filter.....	F-2601	Hydraulic Oil Filter.....	H-2704
Air Filter Set.....	A-5537-S	Fuel Filter.....	F-2621	<b>DH215-9</b> (EXCAVATORS)	
<b>DH130</b> (EXCAVATORS) ISUZU 6BB1		Fuel Filter.....	F-2622	Cabin Air Filter.....	CA-89100
Air Filter Primary.....	AS-7805	Hydraulic Oil Filter.....	H-2704	<b>DH220-9</b> (EXCAVATORS)	
Air Filter Secondary.....	A-7806	<b>DH200W</b> (EXCAVATORS) DAEWOO D1146		Cabin Air Filter.....	CA-89100
Air Filter Set.....	AS-5656-S	Air Filter Primary.....	A-5627	<b>DH225-9</b> (EXCAVATORS)	
Hydraulic Oil Filter.....	H-2704	Air Filter Primary.....	AS-1024	Cabin Air Filter.....	CA-89100
<b>DH130-2</b> (EXCAVATORS) DAEWOO DB58		Air Filter Secondary.....	A-6008	<b>DH215-7</b> (EXCAVATORS) DAEWOO DB58TI	
Air Filter Primary.....	A-5627	Air Filter Secondary.....	A-6009	Hydraulic Oil Filter.....	H-89030
		Air Filter Set.....	A-5663-S	<b>DH220LC-7</b> (EXCAVATORS) DAEWOO DB58TI	
		Air Filter Set.....	AS-1024-S	Hydraulic Oil Filter.....	H-89030
		Fuel Filter.....	F-2601		
		Fuel Filter.....	F-2621		
		Fuel Filter.....	F-2622		
		Hydraulic Oil Filter.....	H-2704		

# Sakura Filter

# ENGINE APPLICATION

MODEL/APPLICATION	SAKURA NO	MODEL/APPLICATION	SAKURA NO	MODEL/APPLICATION	SAKURA NO
<b>DAEWOO</b>		<b>DAEWOO</b>		<b>DAEWOO</b>	
<b>DH225LC-7</b> (EXCAVATORS) DAEWOO DB58TIIS		<b>DX75</b> (EXCAVATORS) YANMAR 4TNV94		<b>MEGA 400</b> (LOADERS)	
Hydraulic Oil Filter.....	H-89030	Fuel Filter Primary.....	FC-52030	Air Filter Primary.....	A-2210
<b>DH258LC-7</b> (EXCAVATORS) DAEWOO DE08TIIS		<b>G20E-3</b> (FORKLIFTS) DAEWOO G424		Fuel Filter.....	F-2603
Hydraulic Oil Filter.....	H-89030	Air Filter.....	A-76410	Fuel Filter.....	F-2604
<b>DH320</b> (EXCAVATORS) DAEWOO D2366		Air Filter Secondary.....	A-8599	Hydraulic Oil Filter.....	H-2704
Air Filter Primary.....	A-2210	Air Filter Set.....	A-76410-S	<b>MEGA 400-3</b> (LOADERS)	
Fuel Filter.....	F-2603	<b>G20S-2</b> (FORKLIFTS) HERCULES 1404 2.7L		Air Filter Primary.....	A-6113
Fuel Filter.....	F-2604	Oil Filter Full Flow.....	C-5504	Air Filter Secondary.....	A-5408
Hydraulic Oil Filter.....	H-2704	<b>G25S</b> (FORKLIFTS)		Fuel/Water Separator.....	SFC-5705
Oil Filter Full Flow.....	C-7942	Air Filter Primary.....	A-5537	Hydraulic Oil Filter.....	H-7911
<b>DH320</b> (EXCAVATORS) DAEWOO D2366T		Air Filter Secondary.....	A-5536	Hydraulic Oil Filter.....	HC-6802
Hydraulic Oil Filter.....	H-89030	Air Filter Set.....	A-5537-S	Oil Filter Full Flow.....	C-7942
<b>DH450</b> (EXCAVATORS) DAEWOO D2848T		<b>M400</b> (LOADERS)		<b>MEGA 400V</b> (LOADERS) DAEWOO DE12T	
Fuel Filter.....	F-2603	Hydraulic Oil Filter.....	H-2704	Fuel/Water Separator.....	SFC-5701-10
Fuel Filter.....	F-2604	<b>MEGA 500</b> (LOADERS) CUMMINS QSM11		Hydraulic Oil Filter.....	H-7911
Hydraulic Oil Filter.....	H-2704	Coolant Filter.....	WC-5705	<b>MEGA 250</b> (LOADERS)	
Hydraulic Oil Filter.....	H-7911	Fuel/Water Separator.....	SFC-5709-10	Hydraulic Oil Filter Transmission... HC-76130	
<b>DH50</b> (EXCAVATORS) DAEWOO DC24		<b>MEGA 500-V</b> (LOADERS) CUMMINS QSM11		<b>MEGA 400-III</b> (LOADERS) DAEWOO D2366T	
Air Filter Primary.....	AS-1014	Coolant Filter.....	WC-5713	Hydraulic Oil Filter.....	HC-5503
Fuel Filter.....	FC-1007	Fuel/Water Separator.....	SFC-5509-10	<b>MK111 S 220</b> (LOADERS)	
<b>DH60-7</b> (EXCAVATORS) YANMAR 4TNV49L		Fuel/Water Separator.....	SFC-5709-10	Hydraulic Oil Filter.....	H-2704
Fuel Filter Primary.....	FC-52030	<b>MEGA 200</b> (LOADERS) DAEWOO DB58T , 2004-UP		<b>RACER</b> (EXCAVATORS)	
<b>DH80-7</b> (EXCAVATORS) YANMAR 4TNV98L		Air Filter Primary.....	AS-1024	Oil Filter Full Flow.....	C-6701
Fuel Filter Primary.....	FC-52030	Air Filter Secondary.....	A-6009	<b>S220LC-III</b> (EXCAVATORS)	
Hydraulic Oil Filter.....	H-89030	Air Filter Set.....	AS-1024-S	Air Filter Primary.....	A-5627
<b>DSL601</b> (LOADERS) YANMAR 4TNE84		Hydraulic Oil Filter.....	H-2704	Air Filter Secondary.....	A-6008
Air Filter Primary.....	AS-9231	<b>MEGA 200-III</b> (LOADERS)		Air Filter Set.....	A-5663-S
Air Filter Secondary.....	A-5016	Hydraulic Oil Filter.....	H-2704	Fuel Filter.....	F-2601
Air Filter Set.....	AS-9231-S	<b>MEGA 200TC-V</b> (LOADERS) 2004-UP		Fuel Filter.....	F-2621
Oil Filter Full Flow.....	C-1011	Fuel/Water Separator.....	SFC-5705	Fuel Filter.....	F-2622
<b>DSL602</b> (LOADERS) YANMAR 4TNE84		<b>MEGA 300</b> (LOADERS) DAEWOO D2366T , 2004-UP		Hydraulic Oil Filter.....	H-2704
Air Filter Secondary.....	A-5016	Air Filter Primary.....	A-2210	Oil Filter Full Flow.....	C-8901
<b>DSL702</b> (LOADERS)		Fuel Filter.....	F-2603	<b>S330</b> (EXCAVATORS)	
Air Filter.....	A-76410	Fuel Filter.....	F-2604	Air Filter Primary.....	A-2210
Air Filter Set.....	A-76410-S	Hydraulic Oil Filter.....	H-2704	Air Filter Secondary.....	A-6008
<b>DX300LC</b> (EXCAVATORS) DOOSAN DL08 , 2005-UP		<b>MEGA 300</b> (LOADERS) DAEWOO DE12T , 2004-UP		<b>S330-III</b> (EXCAVATORS)	
Air Filter Primary.....	AS-8579	Fuel/Water Separator.....	SFC-5701-10	Air Filter Primary.....	A-2210
Air Filter Primary.....	AS-8579M	<b>MEGA 300</b> (LOADERS)		Fuel Filter.....	F-2603
Air Filter Secondary.....	A-8580	Air Filter Primary.....	A-2210	Fuel Filter.....	F-2604
Air Filter Set.....	AS-8579-S	Fuel Filter.....	F-2603	Hydraulic Oil Filter.....	H-7911
Fuel/Water Separator.....	SFC-7939-30	Fuel Filter.....	F-2604	Oil Filter Full Flow.....	C-7942
Fuel/Water Separator.....	SFC-7939-30B	Hydraulic Oil Filter.....	H-2704	<b>S400LC-III</b> (EXCAVATORS)	
Hydraulic Oil Filter.....	H-2719	Air Filter Primary.....	A-2210	Air Filter Primary.....	A-2210
		Fuel Filter.....	F-2603	Fuel Filter.....	F-2603
		Fuel Filter.....	F-2604	Fuel Filter.....	F-2604
		Hydraulic Oil Filter.....	H-2704	Fuel Filter.....	F-2604

MODEL/APPLICATION	SAKURA NO	MODEL/APPLICATION	SAKURA NO	MODEL/APPLICATION	SAKURA NO
<b>DAEWOO</b>		<b>DAEWOO</b>		<b>DAEWOO</b>	
<b>S400LC-III (EXCAVATORS)</b>		<b>SOLAR 170-III (EXCAVATORS) DAEWOO DB58T</b>		<b>SOLAR 220 (EXCAVATORS) DAEWOO D1146</b>	
Hydraulic Oil Filter.....	H-7911	Air Filter Primary.....	A-5627	Air Filter Primary.....	AS-1024
Oil Filter Full Flow.....	C-7942	Air Filter Secondary.....	A-6008	Air Filter Secondary.....	A-6009
<b>S450-III (EXCAVATORS)</b>		Air Filter Set.....	A-5663-S	Air Filter Set.....	AS-1024-S
Air Filter Primary.....	A-89050	Fuel Filter.....	F-2601	<b>SOLAR 220III (EXCAVATORS)</b>	
Air Filter Set.....	A-89050-S	Fuel Filter.....	F-2621	Hydraulic Oil Filter.....	
Fuel Filter.....	F-2603	Fuel Filter.....	F-2622	H-2704	
Fuel Filter.....	F-2604	Hydraulic Oil Filter.....	H-2719	<b>SOLAR 220LCIII (EXCAVATORS) DAEWOO D1146</b>	
Hydraulic Oil Filter.....	H-7911	Hydraulic Oil Filter.....	H-7911	Air Filter Primary.....	A-5627
Oil Filter Full Flow.....	C-8901	Oil Filter Full Flow.....	C-5611	Air Filter Secondary.....	A-6008
<b>SOLAR 015 (EXCAVATORS) ISUZU 3KR1</b>		<b>SOLAR 170LCV (EXCAVATORS) DAEWOO DB58T</b>		Air Filter Set.....	A-5663-S
Air Filter Primary.....	AS-1014	Fuel/Water Separator.....	SFC-5701-10	Fuel Filter.....	F-2601
<b>SOLAR 025 (EXCAVATORS) ISUZU 3KR1</b>		Hydraulic Oil Filter.....	H-7911	Fuel Filter.....	F-2621
Air Filter Primary.....	AS-1014	Oil Filter Full Flow.....	C-5611	Fuel Filter.....	F-2622
<b>SOLAR 035 (EXCAVATORS) ISUZU 3LD1</b>		<b>SOLAR 170W-III (EXCAVATORS) DAEWOO D1146N</b>		Hydraulic Oil Filter.....	H-2704
Air Filter Primary.....	AS-1014	Air Filter Primary.....	A-5627	Oil Filter Full Flow.....	C-8901
<b>SOLAR 035 (EXCAVATORS) ISUZU 3KR1</b>		Air Filter Secondary.....	A-6008	<b>SOLAR 220V (EXCAVATORS)</b>	
Air Filter Primary.....	AS-1014	Air Filter Set.....	A-5663-S	Hydraulic Oil Filter.....	
<b>SOLAR 035 (EXCAVATORS) ISUZU 3KR1</b>		Fuel Filter.....	F-2601	H-2704	
Air Filter Primary.....	AS-1014	Fuel Filter.....	F-2621	<b>SOLAR 280 (EXCAVATORS)</b>	
<b>SOLAR 050 (EXCAVATORS) DAEWOO DC24</b>		Fuel Filter.....	F-2622	Air Filter Primary.....	
Air Filter Primary.....	AS-1024	Fuel/Water Separator.....	SFC-5701-10	A-2210	
Air Filter Secondary.....	A-6009	Hydraulic Oil Filter.....	H-2704	Fuel Filter.....	
Air Filter Set.....	AS-1024-S	Oil Filter Full Flow.....	C-8901	F-2604	
Fuel Filter.....	F-2604	<b>SOLAR 170WV (EXCAVATORS) DAEWOO DB58TI</b>		<b>SOLAR 280LC-III (EXCAVATORS) DAEWOO D2366</b>	
<b>SOLAR 130 (EXCAVATORS) DAEWOO DB58</b>		Air Filter Primary.....	A-5639	Air Filter Primary.....	A-2210
Air Filter Primary.....	A-5627	Air Filter Secondary.....	A-5635	Air Filter Secondary.....	A-6008
Air Filter Secondary.....	A-6008	Air Filter Set.....	A-5654-S	Fuel Filter.....	F-2603
Air Filter Set.....	A-5663-S	Hydraulic Oil Filter.....	H-7911	Fuel Filter.....	F-2604
Oil Filter Full Flow.....	C-5611	Oil Filter Full Flow.....	C-5611	Hydraulic Oil Filter.....	H-7911
<b>SOLAR 130LCV (EXCAVATORS) DAEWOO DB58T</b>		<b>SOLAR 200V (EXCAVATORS)</b>		Oil Filter Full Flow.....	C-7942
Air Filter Primary.....	A-5639	Air Filter Primary.....	A-5639	<b>SOLAR 290LCV (EXCAVATORS) DAEWOO D1146TI</b>	
Air Filter Set.....	A-5654-S	Air Filter Secondary.....	A-5635	Air Filter Primary.....	A-89050
Oil Filter Full Flow.....	C-5611	Air Filter Set.....	A-5654-S	Air Filter Set.....	A-89050-S
<b>SOLAR 130V (EXCAVATORS)</b>		<b>SOLAR 200W-III (EXCAVATORS) DAEWOO D1146</b>		Hydraulic Oil Filter.....	H-2709
Hydraulic Oil Filter.....	H-2704	Air Filter Primary.....	A-5627	<b>SOLAR 290LL (EXCAVATORS) DAEWOO D1146T</b>	
<b>SOLAR 130W (EXCAVATORS)</b>		Air Filter Secondary.....	A-6008	Fuel Filter.....	
Air Filter Primary.....	A-5627	Air Filter Set.....	A-5663-S	H-2704	
Air Filter Secondary.....	A-6008	Fuel Filter.....	F-2601	<b>SOLAR 300LCV (EXCAVATORS) DAEWOO , 2005-UP</b>	
Air Filter Set.....	A-5663-S	Fuel Filter.....	F-2621	Air Filter Primary.....	A-89050
Hydraulic Oil Filter.....	H-2704	Fuel Filter.....	F-2622	Air Filter Set.....	A-89050-S
<b>SOLAR 130W-III (EXCAVATORS) DAEWOO DB58T</b>		Hydraulic Oil Filter.....	H-2704	Fuel/Water Separator.....	SFC-5701-10
Air Filter Primary.....	A-5627	<b>SOLAR 200WV (EXCAVATORS) DAEWOO DB58TI</b>		Fuel/Water Separator.....	SFC-5705
Air Filter Secondary.....	A-6008	Air Filter Primary.....	A-5639	Hydraulic Oil Filter.....	H-2709
Air Filter Set.....	A-5663-S	Air Filter Secondary.....	A-5635	Hydraulic Oil Filter.....	H-2719
Hydraulic Oil Filter.....	H-2704	Air Filter Set.....	A-5654-S	<b>SOLAR 330 (EXCAVATORS) DAEWOO DE12T</b>	
<b>SOLAR 130W-III (EXCAVATORS) DAEWOO DB58T</b>		Hydraulic Oil Filter.....	H-2704	Air Filter Primary.....	AS-1024
Air Filter Primary.....	A-5627	Fuel Filter.....	F-2601	Air Filter Secondary.....	A-6009
Air Filter Secondary.....	A-6008	Fuel Filter.....	F-2621	Air Filter Set.....	AS-1024-S
Air Filter Set.....	A-5663-S	Fuel Filter.....	F-2622	Fuel Filter.....	F-2604
Hydraulic Oil Filter.....	H-2704	Hydraulic Oil Filter.....	H-2704	<b>SOLAR 330 (EXCAVATORS) DAEWOO DE12T</b>	
<b>SOLAR 130W-III (EXCAVATORS) DAEWOO DB58T</b>		<b>SOLAR 200WV (EXCAVATORS) DAEWOO DB58TI</b>		Air Filter Primary.....	AS-1024
Air Filter Primary.....	A-5627	Air Filter Primary.....	A-5639	Air Filter Secondary.....	A-6009
Air Filter Secondary.....	A-6008	Air Filter Secondary.....	A-5635	Air Filter Set.....	AS-1024-S
Air Filter Set.....	A-5663-S	Air Filter Set.....	A-5654-S	Fuel Filter.....	F-2604
Hydraulic Oil Filter.....	H-2704	Hydraulic Oil Filter.....	H-7911	<b>SOLAR 330 (EXCAVATORS) DAEWOO DE12T</b>	
<b>SOLAR 130W-III (EXCAVATORS) DAEWOO DB58T</b>		Oil Filter Full Flow.....	C-5611	Air Filter Primary.....	AS-1024
Air Filter Primary.....	A-5627	<b>SOLAR 200WV (EXCAVATORS) DAEWOO DB58TI</b>		Air Filter Secondary.....	A-6009
Air Filter Secondary.....	A-6008	Air Filter Primary.....	A-5639	Air Filter Set.....	AS-1024-S
Air Filter Set.....	A-5663-S	Air Filter Secondary.....	A-5635	Fuel Filter.....	F-2604
Hydraulic Oil Filter.....	H-2704	Air Filter Set.....	A-5654-S	<b>SOLAR 330 (EXCAVATORS) DAEWOO DE12T</b>	
<b>SOLAR 130W-III (EXCAVATORS) DAEWOO DB58T</b>		Hydraulic Oil Filter.....	H-7911	Air Filter Primary.....	AS-1024
Air Filter Primary.....	A-5627	Oil Filter Full Flow.....	C-5611	Air Filter Secondary.....	A-6009
Air Filter Secondary.....	A-6008	<b>SOLAR 200WV (EXCAVATORS) DAEWOO DB58TI</b>		Air Filter Set.....	AS-1024-S
Air Filter Set.....	A-5663-S	Air Filter Primary.....	A-5639	Fuel Filter.....	F-2604
Hydraulic Oil Filter.....	H-2704	Air Filter Secondary.....	A-5635	<b>SOLAR 330 (EXCAVATORS) DAEWOO DE12T</b>	
<b>SOLAR 130W-III (EXCAVATORS) DAEWOO DB58T</b>		Air Filter Set.....	A-5654-S	Air Filter Primary.....	AS-1024
Air Filter Primary.....	A-5627	Hydraulic Oil Filter.....	H-7911	Air Filter Secondary.....	A-6009
Air Filter Secondary.....	A-6008	Oil Filter Full Flow.....	C-5611	Air Filter Set.....	AS-1024-S
Air Filter Set.....	A-5663-S	<b>SOLAR 200WV (EXCAVATORS) DAEWOO DB58TI</b>		Fuel Filter.....	F-2604
Hydraulic Oil Filter.....	H-2704	Air Filter Primary.....	A-5639	<b>SOLAR 330 (EXCAVATORS) DAEWOO DE12T</b>	
<b>SOLAR 130W-III (EXCAVATORS) DAEWOO DB58T</b>		Air Filter Secondary.....	A-5635	Air Filter Primary.....	AS-1024
Air Filter Primary.....	A-5627	Air Filter Set.....	A-5654-S	Air Filter Secondary.....	A-6009
Air Filter Secondary.....	A-6008	Hydraulic Oil Filter.....	H-7911	Air Filter Set.....	AS-1024-S
Air Filter Set.....	A-5663-S	Oil Filter Full Flow.....	C-5611	Fuel Filter.....	F-2604
Hydraulic Oil Filter.....	H-2704	<b>SOLAR 200WV (EXCAVATORS) DAEWOO DB58TI</b>		<b>SOLAR 330 (EXCAVATORS) DAEWOO DE12T</b>	
<b>SOLAR 130W-III (EXCAVATORS) DAEWOO DB58T</b>		Air Filter Primary.....	A-5639	Air Filter Primary.....	AS-1024
Air Filter Primary.....	A-5627	Air Filter Secondary.....	A-5635	Air Filter Secondary.....	A-6009
Air Filter Secondary.....	A-6008	Air Filter Set.....	A-5654-S	Air Filter Set.....	AS-1024-S
Air Filter Set.....	A-5663-S	Hydraulic Oil Filter.....	H-7911	Fuel Filter.....	F-2604
Hydraulic Oil Filter.....	H-2704	Oil Filter Full Flow.....	C-5611	<b>SOLAR 330 (EXCAVATORS) DAEWOO DE12T</b>	

MODEL/APPLICATION	SAKURA NO
-------------------	-----------

**DAEWOO**

**SOLAR 340LCV**

(EXCAVATORS)

DAEWOO DE12TIS (S/N: 1041-UP) , 2002-UP

- Air Filter Primary..... A-89050
- Air Filter Set..... A-89050-S
- Fuel/Water Separator..... SFC-5705
- Hydraulic Oil Filter..... H-2719

**SOLAR 420LCV**

(EXCAVATORS)

DAEWOO DE12TIS

- Fuel/Water Separator..... SFC-5701-10

**SOLAR 450**

(EXCAVATORS)

DAEWOO DV15T

- Air Filter Primary..... AS-1024
- Air Filter Secondary..... A-6009
- Air Filter Set..... AS-1024-S
- Fuel Filter..... F-2604

**SOLAR 55**

(EXCAVATORS)

ISUZU A-4JB1

- Air Filter Primary..... AS-1014
- Fuel Filter..... FC-1801
- Oil Filter Full Flow..... C-1511
- Oil Filter Full Flow..... C-1538

**SOLAR 70 III**

(EXCAVATORS)

- Hydraulic Oil Filter..... H-2704
- Oil Filter Full Flow..... C-5611

**SOLAR LC320**

(EXCAVATORS)

DAEWOO D1146TI

- Fuel Filter..... F-2603
- Hydraulic Oil Filter..... H-2704

**SOLAR 400LC-V**

(EXCAVATORS)

DAEWOO DE12















- Hydraulic Oil Filter..... H-2719

**B**



# Sakura Filter

# Technical Specification

<p><b>A-2210</b> Air Filter Primary Metal End Cap Element</p>  <p>FIAT 0068473-3 ISUZU 1-14215-018-0 ISUZU 1-14215007-0 NISSAN 16546-96011</p> <p>Secondary Filter uses A-6008 Set Filter uses A-6117-S H 1 : 342.7 (mm) H 2 : 330 (mm) OD 1 : 234 (mm) OD 2 : 234 (mm) ID 1 : 123 (mm) ID 2 : 17 (mm)</p> <p>CONT : 4 VOL : 0.093</p>	<p><b>A-5537-S</b> Air Filter Set Soft PU end cap Element</p>  <p>CATERPILLAR 6I-1450+6I-1451</p> <p>Primary Filter uses A-5537 Secondary Filter uses A-5536 H 1 : 167 (mm) H 2 : 155 (mm) OD 1 : 207 (mm) OD 2 : 207 (mm) ID 1 : 105.5 (mm)</p> <p>CONT : 4 VOL : 0.041</p>	<p><b>A-5663-S</b> Air Filter Set Metal End Cap Element</p>  <p>KOMATSU 600-181-6050</p> <p>Primary Filter uses A-5627 Secondary Filter uses A-6008 H 1 : 380 (mm) H 2 : 330 (mm) OD 1 : 235 (mm) OD 2 : 187 (mm) ID 1 : 120 (mm) ID 2 : 17 (mm)</p> <p>CONT : 1 VOL : 0.030</p>
<p><b>A-5016</b> Air Filter Secondary Metal End Cap Element</p>  <p>FORD 272744 NELSON 70497N CASE D82775</p> <p>Primary Filter uses AS-9231 Set Filter uses AS-9231-S H 1 : 335.4 (mm) H 2 : 330 (mm) OD 1 : 115.5 (mm) OD 2 : 60.5 (mm) ID 1 : 48.5 (mm) ID 2 : 17 (mm)</p> <p>CONT : 9 VOL : 0.055</p>	<p><b>A-5627</b> Air Filter Primary Metal End Cap Element</p>  <p>KOBELCO 2451-U311-3 DAEWOO 2474-6006A DAEWOO 2474-6006B</p> <p>Secondary Filter uses A-6008 Set Filter uses A-5663-S H 1 : 393.7 (mm) H 2 : 381 (mm) OD 1 : 235 (mm) OD 2 : 187 (mm) ID 1 : 120 (mm) ID 2 : 17 (mm)</p> <p>CONT : 1 VOL : 0.026</p>	<p><b>A-6008</b> Air Filter Secondary Metal End Cap Element</p>  <p>ISUZU 1-14215047-0 ISUZU 1-1425-046-1 NISSAN 16546-96010</p> <p>Primary Filter uses A-5627 Set Filter uses A-5663-S H 1 : 330 (mm) OD 1 : 146 (mm) OD 2 : 116.5 (mm) ID 1 : 88 (mm) ID 2 : 17 (mm)</p> <p>CONT : 9 VOL : 0.083</p>
<p><b>A-5408</b> Air Filter Secondary Metal End Cap Element</p>  <p>ISUZU 1-14215034-0 ISUZU 1-14215036-0 NISSAN 16546-96014</p> <p>Primary Filter uses A-6113 Set Filter uses A-5653-S H 1 : 406 (mm) OD 1 : 192.3 (mm) OD 2 : 162.5 (mm) ID 1 : 134.2 (mm) ID 2 : 17 (mm)</p> <p>CONT : 9 VOL : 0.167</p> <p>Note : Is a Secondary Air filter for A-6113,A-54490</p>	<p><b>A-5635</b> Air Filter Secondary Metal End Cap Element</p>  <p>DAEWOO 2474-9054 KOMATSU 600-181-6730 MITSUBISHI ME033839</p> <p>Primary Filter uses A-5639 Set Filter uses A-5654-S H 1 : 414.75 (mm) H 2 : 402 (mm) OD 1 : 133.5 (mm) OD 2 : 133.5 (mm) ID 1 : 105 (mm) ID 2 : 17 (mm)</p> <p>CONT : 9 VOL : 0.086</p>	<p><b>A-6009</b> Air Filter Secondary Metal End Cap Element</p>  <p>NISSAN 16546-96004 KOBELCO 2451U180-3B KOBELCO 2451U206-3 KOMATSU 600-181-8360 ISUZU 9-14215017-0</p> <p>Primary Filter uses AS-1024 Set Filter uses AS-1024-S H 1 : 397 (mm) H 2 : 397 (mm) OD 1 : 146.2 (mm) OD 2 : 166.5 (mm) ID 1 : 88 (mm) ID 2 : 17 (mm)</p> <p>CONT : 9 VOL : 0.101</p>
<p><b>A-5536</b> Air Filter Secondary Soft PU end cap Element</p>  <p>CATERPILLAR 6I-1451</p> <p>Primary Filter uses A-5537 Set Filter uses A-5537-S H 1 : 148 (mm) H 2 : 144 (mm) OD 1 : 108 (mm) OD 2 : 101 (mm) ID 1 : 71 (mm)</p> <p>CONT : 25 VOL : 0.064</p>	<p><b>A-5639</b> Air Filter Primary Metal End Cap Element</p>  <p>KOBELCO 2451-U324-3 MITSUBISHI 3433000400</p> <p>Secondary Filter uses A-5635 Set Filter uses A-5654-S H 1 : 454.7 (mm) H 2 : 442 (mm) OD 1 : 263.5 (mm) OD 2 : 221 (mm) ID 1 : 136 (mm) ID 2 : 23 (mm)</p> <p>CONT : 1 VOL : 0.036</p>	<p><b>A-6113</b> Air Filter Primary Metal End Cap Element</p>  <p>FIAT 01901779 ISUZU 1-14215046-0 NISSAN 16546-96017</p> <p>Secondary Filter uses A-5408 Set Filter uses A-5653-S H 1 : 418.7 (mm) H 2 : 406 (mm) OD 1 : 282 (mm) OD 2 : 282 (mm) ID 1 : 171 (mm) ID 2 : 17 (mm)</p> <p>CONT : 1 VOL : 0.038</p>
<p><b>A-5537</b> Air Filter Primary Soft PU end cap Element</p>  <p>CATERPILLAR 6I-1450</p> <p>Secondary Filter uses A-5536 Set Filter uses A-5537-S H 1 : 167 (mm) H 2 : 155 (mm) OD 1 : 207 (mm) OD 2 : 207 (mm) ID 1 : 105.5 (mm)</p> <p>CONT : 4 VOL : 0.040</p>	<p><b>A-5654-S</b> Air Filter Set Metal End Cap Element</p>  <p>KOMATSU 600-181-6740</p> <p>Primary Filter uses A-5639 Secondary Filter uses A-5635 H 1 : 454.7 (mm) H 2 : 442 (mm) OD 1 : 263.5 (mm) OD 2 : 221 (mm) ID 1 : 135 (mm) ID 2 : 23 (mm)</p> <p>CONT : 1 VOL : 0.036</p>	<p><b>A-7619</b> Air Filter Secondary Metal End Cap Element</p>  <p>MASSEY-FERGUSON 3580724M1 LIEBHERR 7403951 JOHN DEERE RE42762</p> <p>Primary Filter uses AS-7621 Set Filter uses AS-7622-S H 1 : 393.7 (mm) H 2 : 381 (mm) OD 1 : 151 (mm) OD 2 : 151 (mm) ID 1 : 123 (mm) ID 2 : 17 (mm)</p> <p>CONT : 9 VOL : 0.120</p>

**A-76410** Air Filter Soft PU end cap Element



HYUNDAI 11FK-20080  
CASE 133720A1  
TOYOTA 17741U-2100-71  
DAEWOO A213939  
JOHN DEERE RE68043

H 1 : 312 (mm)  
H 2 : 304 (mm)  
OD 1 : 127.5 (mm)  
OD 2 : 127.5 (mm)  
ID 1 : 83 (mm)

CONT : 25  
VOL : 0.169

Note : Flame Retardant version of A-8505

**A-8599** Air Filter Secondary Soft PU end cap Element



KUBOTA 119005-12571  
CASE 133721A1  
HITACHI 4326841

Primary Filter uses A-8505  
Set Filter uses A-8602-S

H 1 : 303.5 (mm)  
H 2 : 298 (mm)  
OD 1 : 83 (mm)  
OD 2 : 79 (mm)  
ID 1 : 64 (mm)

CONT : 25  
VOL : 0.076

Note : Is a Secondary Air filter for A-5669,A-8505

**AS-1024** Air Filter Primary Metal End Cap Element With Sleeve



NISSAN 16546-96003  
NISSAN 16546-96015  
NISSAN 16546-96026

Secondary Filter uses A-6009  
Set Filter uses AS-1024-S

H 1 : 418.7 (mm)  
H 2 : 406 (mm)  
OD 1 : 254 (mm)  
OD 2 : 201.5 (mm)  
ID 1 : 135.5 (mm)  
ID 2 : 17 (mm)

CONT : 1  
VOL : 0.031

**A-76410-S** Air Filter Set Soft PU end cap Element



CASE 133720A1+133721A1  
DAEWOO A213939+A213938  
JOHN DEERE RE68048+RE68049

Primary Filter uses A-76410  
Secondary Filter uses A-8599

H 1 : 312 (mm)  
H 2 : 304 (mm)  
OD 1 : 127.5 (mm)  
OD 2 : 127.5 (mm)  
ID 1 : 83 (mm)

CONT : 25  
VOL : 0.169

**A-89050** Air Filter Primary Metal End Cap Element



DAEWOO 2474-9051

Secondary Filter uses A-89060  
Set Filter uses A-89050-S

H 1 : 493 (mm)  
H 2 : 480 (mm)  
OD 1 : 276 (mm)  
OD 2 : 275 (mm)  
ID 1 : 165 (mm)  
ID 2 : 18 (mm)

CONT : 1  
VOL : 0.047

**AS-1024-S** Air Filter Set Metal End Cap Element With Sleeve



FIAT 1930751+1930790  
KOMATSU 6131-82-7011  
FIAT 70684732+1930790  
JOHN DEERE T46316+T46317

Primary Filter uses AS-1024  
Secondary Filter uses A-6009

H 1 : 418.7 (mm)  
H 2 : 406 (mm)  
OD 1 : 254 (mm)  
OD 2 : 201.5 (mm)  
ID 1 : 135.5 (mm)  
ID 2 : 17 (mm)

CONT : 1  
VOL : 0.031

**A-7806** Air Filter Secondary Metal End Cap Element



YANMAR 119131-12520  
ISUZU 14215-167  
DAEWOO 2474-9014

Primary Filter uses AS-7805  
Set Filter uses AS-5656-S

H 1 : 337 (mm)  
H 2 : 330 (mm)  
OD 1 : 85.5 (mm)  
OD 2 : 85.5 (mm)  
ID 1 : 57.5 (mm)  
ID 2 : 17 (mm)

CONT : 25  
VOL : 0.106

Note : Is a secondary Air Filter for AS-7805,AS-7813,A-7805

**A-89050-S** Air Filter Set Metal End Cap Element



DAEWOO 2474-9051+2474-9057

Primary Filter uses A-89050  
Secondary Filter uses A-89060

H 1 : 493 (mm)  
H 2 : 480 (mm)  
OD 1 : 276 (mm)  
OD 2 : 275 (mm)  
ID 1 : 134 (mm)  
ID 2 : 17 (mm)

CONT : 1  
VOL : 0.041

**AS-5656-S** Air Filter Set Metal End Cap Element With Sleeve



KOMATSU 600-181-9500

Primary Filter uses AS-7805  
Secondary Filter uses A-7806

H 1 : 392 (mm)  
H 2 : 381 (mm)  
OD 1 : 199.3 (mm)  
OD 2 : 155 (mm)  
ID 1 : 88 (mm)  
ID 2 : 17 (mm)

CONT : 9  
VOL : 0.169

**A-7954** Air Filter Primary Metal End Cap Element



ATLAS COPCO 3216-7082-01

Secondary Filter uses A-7809  
Set Filter uses A-7954-S

H 1 : 419.7 (mm)  
H 2 : 407 (mm)  
OD 1 : 234 (mm)  
OD 2 : 276 (mm)  
ID 1 : 122.5 (mm)  
ID 2 : 15 (mm)

CONT : 1  
VOL : 0.037

**A-89060** Air Filter Secondary Metal End Cap Element



DAEWOO 2474-9057

Primary Filter uses A-89050  
Set Filter uses A-89050-S

H 1 : 453.7 (mm)  
H 2 : 441 (mm)  
OD 1 : 162.5 (mm)  
OD 2 : 162.5 (mm)  
ID 1 : 134 (mm)  
ID 2 : 17 (mm)

CONT : 9  
VOL : 0.146

**AS-7805** Air Filter Primary Metal End Cap Element With Sleeve



IVECO 08014390  
MASSEY-FERGUSON 1093682M91  
ISUZU 14215-166

Secondary Filter uses A-7806  
Set Filter uses AS-5656-S

H 1 : 392 (mm)  
H 2 : 381 (mm)  
OD 1 : 199 (mm)  
OD 2 : 155 (mm)  
ID 1 : 88 (mm)  
ID 2 : 17 (mm)  
Gasket Type : Square

CONT : 9  
VOL : 0.169

Note : Long Life Versions Uses AS-7813

**A-8580** Air Filter Secondary Soft PU end cap Element



CATERPILLAR 142-1403  
ATLAS COPCO 3222-1881-92  
HITACHI 4466268

Primary Filter uses A-8579  
Set Filter uses A-8579-S

H 1 : 500 (mm)  
H 2 : 494 (mm)  
OD 1 : 179 (mm)  
OD 2 : 174 (mm)  
ID 1 : 148 (mm)

CONT : 1  
VOL : 0.019

Note : Is a Secondary Air filter of A-8579M,A-8665M

**AS-1014** Air Filter Primary Metal End Cap Element With Sleeve



ISUZU 1-14215135-0  
TOYOTA 1001905  
YANMAR 171064-12540

Secondary Filter uses A-7919  
Set Filter uses AS-1014-S

H 1 : 288 (mm)  
H 2 : 279 (mm)  
OD 1 : 160 (mm)  
OD 2 : 134 (mm)  
ID 1 : 66.5 (mm)  
ID 2 : 17 (mm)

CONT : 9  
VOL : 0.090

**AS-8579** Air Filter Primary Soft PU end cap Element With Sleeve



VOLVO 11033996  
VOLVO BM 110339967  
CATERPILLAR 142-1340

Secondary Filter uses A-8580  
Set Filter uses AS-8579-S

H 1 : 521 (mm)  
H 2 : 510 (mm)  
OD 1 : 313 (mm)  
OD 2 : 313 (mm)  
ID 1 : 178 (mm)

CONT : 1  
VOL : 0.057

# Sakura Filter

# Technical Specification

**AS-8579-S** Air Filter Set Soft PU end cap Element With Sleeve

TEREX 15270188 + 15270189  
HITACHI 76612497+4466268



Primary Filter uses AS-8579  
Secondary Filter uses A-8580  
H 1 : 521 (mm)  
H 2 : 510 (mm)  
OD 1 : 313 (mm)  
OD 2 : 313 (mm)  
ID 1 : 178 (mm)

CONT : 1  
VOL : 0.057

**C-1511** Oil Filter Full Flow Spin-On

ISUZU 8-94217272-0  
ISUZU 8-94360426-0  
ISUZU 8-94430983-0



H 1 : 100 (mm)  
OD 1 : 90 (mm)  
Thread Size : M20X1.5-6H  
BPV (kg/cm2) : 1.0  
ADBV : YES  
Gasket Type : Round

CONT : 25  
VOL : 0.029

**C-56191** Oil Filter Full Flow Spin-On long life

KOMATSU 600-211-2110  
CASE 87409203  
NEW HOLLAND (CNH) 87415600  
CUMMINS C6002112110



H 1 : 86.5 (mm)  
OD 1 : 76 (mm)  
Thread Size : 3/4-16 UNF-2B  
BPV (kg/cm2) : 1.0  
ADBV : YES  
Gasket Type : Square

CONT : 36  
VOL : 0.032

Note : C-56190(bottom plate difference)

**AS-8579M** Air Filter Primary Soft PU+Metal Element With Sleeve

HITACHI 76612497



Secondary Filter uses A-8580  
Set Filter uses AS-8579M-S  
H 1 : 521 (mm)  
H 2 : 510 (mm)  
OD 1 : 313 (mm)  
OD 2 : 313 (mm)  
ID 1 : 178 (mm)

CONT : 1  
VOL : 0.060

Note : with metal reinforcement

**C-1538** Oil Filter Full Flow Spin-On

HOLDEN 8-9421-7272-2



H 1 : 95 (mm)  
OD 1 : 93 (mm)  
Thread Size : M20X1.5-6H  
BPV (kg/cm2) : 1.0  
ADBV : YES  
Gasket Type : Square

CONT : 25  
VOL : 0.037

Note : C-1503,C-1511 (bottom plate difference)

**C-6701** Oil Filter Full Flow Spin-On

GENERAL MOTORS 25010792  
OPEL 650381  
ISUZU 8-25010792-0



H 1 : 85.5 (mm)  
OD 1 : 76 (mm)  
Thread Size : M18X1.5-6H  
Gasket Type : Square

CONT : 50  
VOL : 0.034

**AS-9231** Air Filter Primary Metal End Cap Element With Sleeve

FORD 221406  
CATERPILLAR 3I-0823



Secondary Filter uses A-5016  
Set Filter uses AS-9231-S  
H 1 : 362 (mm)  
H 2 : 355.5 (mm)  
OD 1 : 131.5 (mm)  
OD 2 : 104 (mm)  
ID 1 : 63 (mm)  
ID 2 : 17 (mm)

CONT : 9  
VOL : 0.070

**C-5102** Oil Filter Full Flow Spin-On

PERKINS 26540347  
PERKINS 2654407



H 1 : 168 (mm)  
OD 1 : 93 (mm)  
Thread Size : 3/4-16 UNF-2B  
BPV (kg/cm2) : 1.0  
ADBV : YES  
Gasket Type : Square

CONT : 25  
VOL : 0.050

**C-7942** Oil Filter Full Flow Spin-On

DAEWOO 65.05510-5017  
DAEWOO 65.05510-5020



H 1 : 246.5 (mm)  
OD 1 : 115.9 (mm)  
Thread Size : 1 1/2-12 UNF-2B  
ADBV : YES  
Gasket Type : Square

CONT : 6  
VOL : 0.029

**AS-9231-S** Air Filter Set Metal End Cap Element With Sleeve

FORD 221406+272744



Primary Filter uses AS-9231  
Secondary Filter uses A-5016  
H 1 : 362 (mm)  
H 2 : 355.5 (mm)  
OD 1 : 131.5 (mm)  
OD 2 : 104 (mm)  
ID 1 : 63 (mm)  
ID 2 : 17 (mm)

CONT : 9  
VOL : 0.079

**C-5504** Oil Filter Full Flow Spin-On

CATERPILLAR 1R-0734  
CATERPILLAR 9L-9054  
CATERPILLAR 9L-9200



H 1 : 145 (mm)  
OD 1 : 93 (mm)  
Thread Size : 1-12 UNF-2B  
BPV (kg/cm2) : 1.0  
Gasket Type : Square

CONT : 25  
VOL : 0.041

**C-8901** Oil Filter Full Flow Spin-On

DAEWOO 65.05510.5022  
DAEWOO 65.05510.5022B  
DAEWOO 650.5510.5016



H 1 : 203 (mm)  
OD 1 : 118 (mm)  
Thread Size : 1 1/2-12 UNF-2B  
ADBV : YES  
Gasket Type : Round

CONT : 6  
VOL : 0.022

**C-1011** Oil Filter Full Flow Spin-On

JAC 1017100GG010  
NISSAN 15208-HC400  
HINO 15607-1920  
MAZDA JEYO-14-302



H 1 : 85 (mm)  
OD 1 : 68 (mm)  
Thread Size : M20X1.5-6H  
BPV (kg/cm2) : 1.0  
ADBV : YES  
Gasket Type : Round

CONT : 50  
VOL : 0.026

Note : Square version uses C-1030

**C-5611** Oil Filter Full Flow Spin-On Synthetic Media

CUMMINS 3977910  
KOMATSU 6736-51-5142



H 1 : 174.4 (mm)  
OD 1 : 93 (mm)  
Thread Size : 1-16 UNF-2B  
ADBV : YES  
Gasket Type : Square

CONT : 12  
VOL : 0.027

Note : C-5610 cellulose media,C-5611 syntetic media

**CA-89100** Cabin Air Filter Plastic framed Element

DOOSAN 471-00119



H 1 : 34.5 (mm)  
Length 1 : 301 (mm)  
Width 1 : 147 (mm)

CONT : 20  
VOL : 0.068

Note : Daewoo Excavator model:DH225-9/DH220-9/DH215-9

**F-2601** Fuel Filter Metal End Cap Element

MERCEDES-BENZ 1457431261  
IVECO 190605  
DAEWOO 65.12503-5003



H 1 : 113 (mm)  
H 2 : 107 (mm)  
OD 1 : 64 (mm)  
OD 2 : 64 (mm)  
ID 1 : 12.8 (mm)  
ID 2 : 12.8 (mm)

CONT : 50  
VOL : 0.035

Note : Paper Protector

**F-5210** Fuel Filter Metal End Cap Element

YANMAR 129100-55650  
KUBOTA 15521-43160  
KUBOTA 607



H 1 : 89 (mm)  
OD 1 : 50 (mm)  
OD 2 : 50 (mm)  
ID 1 : 20 (mm)

CONT : 50  
VOL : 0.017

**H-2704** Hydraulic Oil Filter Metal End Cap Element

DAEWOO 2474-9003B  
DAEWOO 2474-9008  
HITACHI 4227353



H 1 : 456 (mm)  
H 2 : 438 (mm)  
OD 1 : 112 (mm)  
OD 2 : 112 (mm)  
ID 1 : 66.1 (mm)  
ID 2 : 66.1 (mm)

CONT : 10  
VOL : 0.079

**F-2603** Fuel Filter Metal End Cap Element

MERCEDES-BENZ 000 477 31 15  
DAIMLER BENZ 4220900051  
STEYR-DAIMLER-PUCH 614080740



H 1 : 145 (mm)  
H 2 : 130 (mm)  
OD 1 : 84.5 (mm)  
OD 2 : 84.5 (mm)  
ID 1 : 13 (mm)  
ID 2 : 13 (mm)

CONT : 50  
VOL : 0.062

**FC-1007** Fuel Filter Spin-On

CATERPILLAR 103-2901  
TOYOTA 233203391071



H 1 : 100 (mm)  
H 2 : 100 (mm)  
OD 1 : 80 (mm)  
Thread Size : M20X1.5-6H  
Gasket Type : Round

CONT : 50  
VOL : 0.041

**H-2709** Hydraulic Oil Filter Metal End Cap Element

KOMATSU 07063-01383  
KOMATSU 208-60-61150  
HITACHI 4287634  
HITACHI 76580323

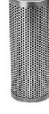

H 1 : 450 (mm)  
OD 1 : 180 (mm)  
OD 2 : 180 (mm)  
ID 1 : 110 (mm)  
ID 2 : 110 (mm)

CONT : 9  
VOL : 0.173

**F-2604** Fuel Filter Metal End Cap Element

MERCEDES-BENZ 000 477 40 15  
MERCEDES-BENZ 000 477 45 15  
MERCEDES-BENZ 355 470 01 92



H 1 : 145 (mm)  
H 2 : 138 (mm)  
OD 1 : 83 (mm)  
OD 2 : 83 (mm)  
ID 1 : 14 (mm)  
ID 2 : 14 (mm)

CONT : 50  
VOL : 0.062

**FC-1801** Fuel Filter Spin-On

NISSAN 16403-09W00  
NISSAN 16403-27000



H 1 : 80 (mm)  
OD 1 : 80 (mm)  
Thread Size : 3/4-16 UNF-2B  
Gasket Type : Round

CONT : 50  
VOL : 0.037

**H-2719** Hydraulic Oil Filter Metal End Cap Element Cellulose media

HYUNDAI 31E3-0018  
HITACHI 4294135  
YAMASHIN DT-04-10-10



H 1 : 87 (mm)  
H 2 : 83.5 (mm)  
OD 1 : 42.5 (mm)  
OD 2 : 42.5 (mm)  
ID 1 : 21.5 (mm)

CONT : 50  
VOL : 0.011

Note : Wiremesh type uses H-5211

**F-2621** Fuel Filter Metal End Cap Element

MERCEDES-BENZ 352 470 00 92



H 1 : 114.6 (mm)  
H 2 : 101 (mm)  
OD 1 : 64 (mm)  
OD 2 : 64 (mm)  
ID 1 : 12.8 (mm)  
ID 2 : 12.8 (mm)

CONT : 50  
VOL : 0.032

**FC-5103** Fuel Filter Can-type Housing

ALLIS CHALMERS 1919100  
MANITOU 49660  
CASE K915319



H 1 : 71 (mm)  
OD 1 : 85 (mm)  
OD 2 : 89 (mm)  
ID 1 : 39 (mm)  
ID 2 : 15 (mm)

CONT : 50  
VOL : 0.036

**H-7911** Hydraulic Oil Filter Metal End Cap Element

KOMATSU 07063-01210  
KOMATSU 205-60-51430



H 1 : 450 (mm)  
OD 1 : 150 (mm)  
OD 2 : 150 (mm)  
ID 1 : 110 (mm)  
ID 2 : 110 (mm)

CONT : 6  
VOL : 0.080

Note : Without gasket

**F-2622** Fuel Filter Metal End Cap Element

MERCEDES-BENZ 4773815  
DAEWOO 65125035001  
CASE 714401R92  
CLAAS 99104



H 1 : 112 (mm)  
H 2 : 102 (mm)  
OD 1 : 69 (mm)  
OD 2 : 69 (mm)  
ID 1 : 19 (mm)  
ID 2 : 19 (mm)

CONT : 50  
VOL : 0.034

**FC-52030** Fuel Filter Primary Spin-On

YANMAR 123907-55801



H 1 : 159 (mm)  
OD 1 : 90 (mm)  
Thread Size : M20X1.5-6H  
Gasket Type : Round

CONT : 25  
VOL : 0.052

**H-7923** Hydraulic Oil Filter Element With Microfiber media

KOBELCO YN52V01011P1  
KOBELCO YN52V01016R100



H 1 : 249 (mm)  
H 2 : 231 (mm)  
OD 1 : 144 (mm)  
OD 2 : 142.5 (mm)  
ID 1 : 96.5 (mm)  
ID 2 : 96.5 (mm)  
Thread Size : 4 7/16-11 G

CONT : 12  
VOL : 0.082

# Sakura Filter

# Technical Specification

**H-89030** Hydraulic Oil Filter Metal End Cap Element

DAEWOO 2474-9016A  
DOOSAN 2474-9016A



H 1 : 146 (mm)  
H 2 : 140 (mm)  
OD 1 : 150 (mm)  
OD 2 : 150 (mm)  
ID 1 : 73.4 (mm)  
Thread Size : M12X1.75-6H

CONT : 9  
VOL : 0.045

61

**SFC-5701-10** Fuel/Water Separator Spin-On 10 Micron

CASE 335341A1  
CUMMINS 3413084  
DAEWOO 65125035016



H 1 : 174 (mm)  
OD 1 : 93 (mm)  
Thread Size : 1-14 UNS-2B  
Gasket Type : Square

CONT : 12  
VOL : 0.031

66

**WC-5705** Coolant Filter Spin-On

CUMMINS 299080  
CUMMINS 3100304  
CUMMINS 3305367



H 1 : 100 (mm)  
OD 1 : 93 (mm)  
Thread Size : 11/16-16 UNF-2B  
Gasket Type : Square

CONT : 12  
VOL : 0.018

Note : Coolants = 4 units

71

**HC-5503** Hydraulic Oil Filter Spin-On Synthetic Media

CATERPILLAR 1081153  
INGERSOLL RAND 51302214  
VOLVO BM 9658998



H 1 : 293 (mm)  
OD 1 : 122 (mm)  
Thread Size : 1 3/4-12 UNF-2B

CONT : 6  
VOL : 0.032

Note : with Glass Fiber media

62

**SFC-5705** Fuel/Water Separator Spin-On

ISUZU 1-13240044-1  
CUMMINS 3308638  
CUMMINS 3315843  
SUNWARD 750201011130



H 1 : 174 (mm)  
OD 1 : 93 (mm)  
Thread Size : 1-14 UNS-2B  
Gasket Type : Square

CONT : 12  
VOL : 0.026

67

**WC-5713** Coolant Filter Spin-On

HITACHI 4228689  
INGERSOLL RAND 57165805



H 1 : 136 (mm)  
OD 1 : 93 (mm)  
Thread Size : 11/16-16 UNF-2B  
Gasket Type : Square

CONT : 12  
VOL : 0.022

Note : Coolants = 15 units

72

**HC-6802** Hydraulic Oil Filter Spin-On

MASSEY-FERGUSON 2979653M1  
VOLVO 4787923  
INGERSOLL RAND 54672654



H 1 : 200 (mm)  
OD 1 : 93 (mm)  
Thread Size : 1-12 UNF-2B  
ADBV : YES  
Gasket Type : Square

CONT : 12  
VOL : 0.034

63

**SFC-5709-10** Fuel/Water Separator Spin-On 10 Micron

CATERPILLAR 256-8753  
CUMMINS 3329289  
HITACHI 4377880



H 1 : 245 (mm)  
OD 1 : 93 (mm)  
Thread Size : 1-14 UNS-2B  
Gasket Type : Square

CONT : 6  
VOL : 0.019

68

**HC-76130** Hydraulic Oil Filter Transmission Spin-On With Microfiber media

ZF 0501323154  
J.C.BAMFORD 32925905  
CASE 8603535  
CASE 87519452  
JOHN DEERE AT336140



H 1 : 199 (mm)  
OD 1 : 94.5 (mm)  
Thread Size : 1 3/8-12 UNF-2B  
Thread Stud Size : M24X1.5

CONT : 12  
VOL : 0.024

64

**SFC-7939-30** Fuel/Water Separator Spin-On 30 Micron

DAF 143 3649  
MAN 51.12503.0052  
DOOSAN K1006529



H 1 : 229 (mm)  
OD 1 : 108 (mm)  
Thread Size : 1-14 UNS-2B  
Gasket Type : Square

CONT : 6  
VOL : 0.024

Note : bowl not included

69

**SFC-5509-10** Fuel/Water Separator Spin-On 10 Micron

CUMMINS 3406889  
CUMMINS 3954891  
CUMMINS 3954904  
CUMMINS 4070801



H 1 : 211 (mm)  
OD 1 : 93 (mm)  
Thread Size : 1-14 UNS-2B  
Gasket Type : Square

CONT : 12  
VOL : 0.036

65

**SFC-7939-30B** Fuel/Water Separator Spin-On With Bowl 30 Micron

DAF 143 3649  
MAN 511.2503.0052



H 1 : 319 (mm)  
OD 1 : 108 (mm)  
Thread Size : 1-14 UNS-2B  
Gasket Type : Square

CONT : 6  
VOL : 0.030

Note : SFC-7939-30 and FB-7939

70