

VECTOR

PREMIUM QUALITY
FILTERS



HITACHI

FILTER SUB-CATALOGUE



Table of Contents

Engine Application
Technical Specification

A
B

Engine Application

A

Sakura Filter

ENGINE APPLICATION

MODEL/APPLICATION	SAKURA NO	MODEL/APPLICATION	SAKURA NO	MODEL/APPLICATION	SAKURA NO
HITACHI		HITACHI		HITACHI	
450 (EXCAVATORS) ISUZU 68G1		CX900 (CRANES) MITSUBISHI 6D24T (S/N: 000101-UP) , 2006		EH1100 423LD (DUMP TRUCKS)	
Fuel Filter.....	FC-15031	Air Filter Primary.....	A-6113	Air Filter Secondary.....	A-7902
Oil Filter Full Flow.....	C-6001	Air Filter Secondary.....	A-5408	Oil Filter Full Flow.....	C-7303
CG100 (CRAWLER DUMPERS) HINO , 2006		Hydraulic Oil Filter.....	H-2719	EH1100-3 (DUMP TRUCKS) DETROITD DETROIT , 2008	
Fuel Filter.....	F-1303	Hydraulic Oil Filter.....	HC-5602	Air Filter Secondary.....	A-7902
Oil Filter By Pass.....	O-1310	CX900GLS (CRANES) MITSUBISHI 6D24-TC (S/N: 25DP000123-UP)		EH1100-3 (DUMP TRUCKS) w/MTU 2000 Series Eng. (Tier 2)	
Oil Filter Full Flow.....	O-1301	Air Filter Primary.....	A-6113	Fuel Filter.....	FC-6507
CH40-2 (CRAWLER DUMPERS) ISUZU C240		Air Filter Secondary.....	A-5408	EH1600 (DUMP TRUCKS) CUMMINS QST30 SERIES	
Fuel Filter.....	FC-1501	Hydraulic Oil Filter.....	H-2719	Air Filter Primary.....	A-5718
Fuel Filter.....	FC-1824	Hydraulic Oil Filter.....	HC-5602	Air Filter Secondary.....	A-5715
CX1100 (CRANES) ISUZU 6RB1T (S/N: 0503-UP)		CX900HD (CRANES) MITSUBISHI 6D24-TC (S/N: HCME 000101-UP)		Coolant Filter.....	WC-5713
Air Filter Primary.....	A-6113	Air Filter Primary.....	A-6113	Fuel/Water Separator.....	SFC-5601-02
Air Filter Secondary.....	A-5408	Air Filter Secondary.....	A-5408	Fuel/Water Separator.....	SFC-5707
Fuel Filter.....	FC-2703	Hydraulic Oil Filter.....	H-2719	EH1600 (DUMP TRUCKS) CUMMINS QST30	
Hydraulic Oil Filter.....	H-2719	Hydraulic Oil Filter.....	HC-5602	Hydraulic Oil Filter Transmission...	H-85970
Hydraulic Oil Filter.....	HC-5602	EG30 (CRAWLER DUMPERS) ISUZU 3LD2 PA01 , 2006		EH1700 (DUMP TRUCKS) CUMMINS QST30	
Oil Filter By Pass.....	C-1327	Air Filter Primary.....	A-8513	Cabin Air Filter.....	CA-27010
CX400 (CRANES) HINO H07C-TD (S/N: 000101-UP)		Fuel Filter.....	F-5207	Hydraulic Oil Filter Transmission...	H-85970
Hydraulic Oil Filter.....	H-2719	EG70R (CRAWLER DUMPERS) ISUZU 6BG1T C-S (S/N: 010101-UP) , 2006		EH4500 (DUMP TRUCKS) w/Detroit Diesel 16V4000 Eng.	
Hydraulic Oil Filter.....	HC-5602	Air Filter Primary.....	A-5539	Fuel Filter.....	FC-6507
Hydraulic Oil Filter Suction.....	H-2706	Air Filter Primary.....	A-5539M	EH4000 (DUMP TRUCKS) w/Detroit Diesel 16V4000 Eng.	
Oil Filter By Pass.....	C-1327	Air Filter Set.....	A-2709-S	Fuel Filter.....	FC-6507
CX500 (CRANES) HINO H07CT (S/N: 002003-UP)		Air Filter Set.....	A-2709M-S	EH4500-2 (DUMP TRUCKS) DETROIT DIESEL 16V4000	
Hydraulic Oil Filter.....	H-2719	Fuel Filter.....	FC-1503	Hydraulic Oil Filter.....	H-27410
Hydraulic Oil Filter.....	HC-5602	EG70R (CARRIERS) ISUZU 6BG1T		EH5000 (DUMP TRUCKS) w/Detroit Diesel 16V4000 Eng.	
Hydraulic Oil Filter Suction.....	H-2706	Fuel Filter.....	FC-15031	Fuel Filter.....	FC-6507
Oil Filter By Pass.....	C-1327	EG70R (CRAWLER DUMPERS) ISUZU CC-6BG1T		EH4500-2 (DUMP TRUCKS) DETROIT DIESEL 16V4000	
CX550-C (CRANES) HINO H07CT (S/N: 002141-UP)		Hydraulic Oil Filter.....	H-2705	Hydraulic Oil Filter.....	H-27410
Hydraulic Oil Filter.....	H-2719	EG70R (CRAWLER DUMPERS)		EH5000 (DUMP TRUCKS) w/Detroit Diesel 16V4000 Eng.	
Hydraulic Oil Filter.....	HC-5602	Air Filter Primary.....	A-5539	Fuel Filter.....	FC-6507
Hydraulic Oil Filter Suction.....	H-2706	Air Filter Primary.....	A-5539M	EH650 357TD (DUMP TRUCKS) VOLVO	
Oil Filter By Pass.....	C-1327	Air Filter Set.....	A-2709-S	Air Filter Primary.....	A-7118
CX500S (CRANES) HINO H07CT (S/N: 002170-UP)		Air Filter Set.....	A-2709M-S	Air Filter Secondary.....	A-7117
Hydraulic Oil Filter.....	H-2719	Fuel Filter.....	FC-1503	Air Filter Set.....	A-7119-S
Hydraulic Oil Filter.....	HC-5602	EH1000 (DUMP TRUCKS) CUMMINS QSK19		Cabin Air Filter.....	CA-2405
Hydraulic Oil Filter Suction.....	H-2706	Air Filter Primary.....	A-5718	Fuel Filter.....	FC-5723
Oil Filter By Pass.....	C-1327	Air Filter Secondary.....	A-5715	Oil Filter By Pass.....	C-5718
CX700 (CRANES) HINO H07CT (S/N: 000101-UP)		Coolant Filter.....	WC-5712	Oil Filter Full Flow.....	C-7105
Hydraulic Oil Filter.....	H-2719	Fuel/Water Separator.....	SFC-5707	EH700-2 (DUMP TRUCKS) CUMMINS QSK15 , 2004	
Hydraulic Oil Filter.....	HC-5602	Fuel/Water Separator.....	SFC-5709-10	Air Filter Primary.....	A-5718
Hydraulic Oil Filter Suction.....	H-2706	Hydraulic Oil Filter.....	H-85990	Air Filter Secondary.....	A-5715
Oil Filter By Pass.....	C-1327	Oil Filter Combination.....	C-5723	Hydraulic Oil Filter.....	H-85990
CX700HD (CRANES) MITSUBISHI 6D24T (S/N: HCME 000101-UP)		EH1100 (DUMP TRUCKS)		EH700-3 (DUMP TRUCKS) DETROITD 60 SERIES	
Air Filter Primary.....	A-6113	Air Filter Secondary.....	A-7902	Air Filter Secondary.....	A-7902
Air Filter Secondary.....	A-5408	Fuel Filter.....	FC-6505	EH700-3 (DUMP TRUCKS) DETROITD SERIES 60	
Hydraulic Oil Filter.....	H-2719	Fuel/Water Separator.....	SFC-5707	EH700-3 (DUMP TRUCKS) DETROITD SERIES 60	
Hydraulic Oil Filter.....	HC-5602	Oil Filter Full Flow.....	C-7303		

MODEL/APPLICATION	SAKURA NO	MODEL/APPLICATION	SAKURA NO	MODEL/APPLICATION	SAKURA NO
HITACHI		HITACHI		HITACHI	
EH700-3 (DUMP TRUCKS) DETROIT SERIES 60 Hydraulic Oil Filter Transmission... H-85970		Air Filter Primary..... A-2702		Air Filter Set..... A-2703-S	
EH700-3 (DUMP TRUCKS) w/Detroit Diesel Series 60 Eng. Fuel Filter..... FC-6507		Air Filter Secondary..... A-2704		Air Filter Set..... A-2711-S	
EH750-2 (DUMP TRUCKS) CUMMINS QSX15 , 2004 Air Filter Primary..... A-5718		Air Filter Set..... A-2702-S		Fuel Filter..... FC-2702	
Air Filter Secondary..... A-5715		Fuel Filter..... FC-15031		Hydraulic Oil Filter..... H-2703	
Hydraulic Oil Filter..... H-85990		Fuel Filter..... FC-1801		Hydraulic Oil Filter..... H-2704	
EH750-3 (DUMP TRUCKS) DETROIT SERIES 60 , 2007 Coolant Filter..... WC-5708		Hydraulic Oil Filter..... H-2703		Hydraulic Oil Filter..... H-2714	
Coolant Filter..... WC-5712		Hydraulic Oil Filter..... H-2704		Oil Filter Full Flow..... C-2702	
EX1100-3 (EXCAVATORS) CUMMINS QSK19 Air Filter Primary..... A-5718		Oil Filter Full Flow..... C-2702			
Air Filter Secondary..... A-5715		EX100-2 (EXCAVATORS) ISUZU 4BDL Air Filter Primary..... A-2702		EX120 (EXCAVATORS) ISUZU 4BD1T Fuel Filter..... FC-15031	
Coolant Filter..... WC-5703		Air Filter Secondary..... A-2704			
Coolant Filter..... WC-5713		Air Filter Set..... A-2702-S		EX1200-5 (EXCAVATORS) MITSUBISHI S6R-Y1TAA1 Air Filter Primary..... A-5629	
Fuel/Water Separator..... SFC-5709-10		Fuel Filter..... FC-1801		Air Filter Secondary..... A-5630	
Hydraulic Oil Filter..... H-2703		Hydraulic Oil Filter..... H-2703		Air Filter Set..... A-5629-S	
Hydraulic Oil Filter..... HC-5602		Hydraulic Oil Filter..... H-2704		Fuel Filter..... FC-1810	
Hydraulic Oil Filter Suction..... H-2706		Oil Filter Full Flow..... C-2702		Fuel/Water Separator Primary..... SF-1912-30	
Oil Filter Combination..... C-5723				Hydraulic Oil Filter..... H-2703	
EX1800-3 (EXCAVATORS) CUMMINS QSK19C Air Filter..... A-2715		EX100-3 (EXCAVATORS) ISUZU 4BD1 Fuel Filter..... FC-15031		Hydraulic Oil Filter..... H-2709	
Air Filter Primary..... A-5718		EX100-3 (EXCAVATORS) ISUZU 4BG1 Fuel Filter..... FC-1824		Hydraulic Oil Filter..... HC-5602	
Air Filter Secondary..... A-5715		EX100-5 (EXCAVATORS) ISUZU 4BG1 Air Filter Primary..... A-2702		Hydraulic Oil Filter Suction..... H-2706	
Coolant Filter..... WC-5703		Air Filter Secondary..... A-2704		Oil Filter By Pass..... C-5718	
Coolant Filter..... WC-5713		Air Filter Set..... A-2702-S			
Fuel/Water Separator..... SFC-5709-10		Fuel Filter..... FC-1005		EX1200-5 (EXCAVATORS) W/MITSUBISHI S6R-Y1T ENG. Cabin Air Filter..... CA-27050	
Hydraulic Oil Filter..... H-5505		Fuel Filter..... FC-1801		Fuel Filter..... FC-58010	
Oil Filter Combination..... C-5723		Fuel Filter..... FC-1824			
EX100 (EXCAVATORS) ISUZU 4BD1 , 1988 Air Filter Primary..... A-2703		Hydraulic Oil Filter..... H-2703		EX1200-5C (EXCAVATORS) MITSUBISHI S6R-Y1TAA1 Air Filter Primary..... A-5629	
Air Filter Secondary..... A-2704		Hydraulic Oil Filter..... H-2704		Air Filter Secondary..... A-5630	
Air Filter Set..... A-2703-S		Hydraulic Oil Filter Suction..... H-2706		Air Filter Set..... A-5629-S	
Fuel Filter..... FC-2702		Oil Filter By Pass..... C-5718		Fuel Filter..... FC-1810	
Hydraulic Oil Filter..... H-2703		Oil Filter Full Flow..... C-5715		Hydraulic Oil Filter..... H-2703	
Hydraulic Oil Filter..... H-2704				Hydraulic Oil Filter..... H-2709	
Hydraulic Oil Filter..... H-2714		EX100M-5 (EXCAVATORS) ISUZU 4BG1 Fuel Filter..... FC-1824		Hydraulic Oil Filter..... HC-5602	
Oil Filter Full Flow..... C-2702		EX1100 (EXCAVATORS) HITACHI KTTA19C Air Filter Primary..... A-5718		Hydraulic Oil Filter Suction..... H-2706	
EX100 (EXCAVATORS) ISUZU 4BD1 Fuel Filter..... FC-15031		Air Filter Secondary..... A-5715		Oil Filter By Pass..... C-5201	
EX1000 (EXCAVATORS) HITACHI 6RB1T , 1988 Air Filter Secondary..... A-5408		Coolant Filter..... WC-5713		Oil Filter By Pass..... C-5718	
Fuel Filter..... FC-2703		Fuel Filter..... FC-5702			
Hydraulic Oil Filter..... H-2704		Hydraulic Oil Filter..... H-2703		EX1200-5C (EXCAVATORS) MITSUBISHI S6R-Y1T Cabin Air Filter..... CA-27040	
Oil Filter Full Flow..... C-1312		Hydraulic Oil Filter Suction..... H-2706		Fuel Filter..... FC-58010	
EX100-2 (EXCAVATORS) ISUZU 4BD1 Fuel Filter..... FC-15031		Oil Filter By Pass..... C-5718			
EX100-2 (EXCAVATORS) ISUZU 4BD1 Fuel Filter..... FC-15031		Oil Filter Full Flow..... C-5715		EX1200-5C (EXCAVATORS) W/MITSUBISHI S6R-Y1T ENG. Cabin Air Filter..... CA-27050	
EX100-2 (EXCAVATORS) ISUZU 4BD1 Fuel Filter..... FC-15031		EX12 (EXCAVATORS) ISUZU 3KC1 , 1990 Fuel Filter..... FC-1006			
EX100-2 (EXCAVATORS) ISUZU 4BD1 Fuel Filter..... FC-15031		Hydraulic Oil Filter..... H-2712		EX120-2 (EXCAVATORS) ISUZU 4BD1T Air Filter Secondary..... A-7956	
EX100-2 (EXCAVATORS) ISUZU 4BD1 Fuel Filter..... FC-15031		Hydraulic Oil Filter..... HC-5807		Fuel Filter..... FC-1005	
EX100-2 (EXCAVATORS) ISUZU 4BD1 Fuel Filter..... FC-15031		Oil Filter Full Flow..... C-1011		Fuel Filter..... FC-15031	
EX100-2 (EXCAVATORS) ISUZU 4BD1 Fuel Filter..... FC-15031		EX120 (EXCAVATORS) ISUZU 4BD1T , 1988 Air Filter Primary..... A-2703		Fuel Filter..... FC-1801	
EX100-2 (EXCAVATORS) ISUZU 4BD1 Fuel Filter..... FC-15031		Air Filter Primary..... A-2708		Fuel Filter..... FC-1824	
EX100-2 (EXCAVATORS) ISUZU 4BD1 Fuel Filter..... FC-15031		Air Filter Secondary..... A-7956		Hydraulic Oil Filter..... H-2703	
EX100-2 (EXCAVATORS) ISUZU 4BD1 Fuel Filter..... FC-15031				Hydraulic Oil Filter..... H-2704	

MODEL/APPLICATION	SAKURA NO	MODEL/APPLICATION	SAKURA NO	MODEL/APPLICATION	SAKURA NO
HITACHI		HITACHI		HITACHI	
EX120-2 (EXCAVATORS) ISUZU 4BD1T		Hydraulic Oil Filter.....	HC-5807	Fuel Filter.....	FC-1801
Oil Filter By Pass.....	C-15680	EX1800 (EXCAVATORS) CUMMINS KTA-19C		Hydraulic Oil Filter.....	H-2703
Oil Filter Full Flow.....	C-2702	Air Filter.....	A-2715	Hydraulic Oil Filter.....	H-2704
Oil Filter Full Flow.....	C-6001	Air Filter Primary.....	A-5718	Oil Filter By Pass.....	C-15680
EX120-5 (EXCAVATORS) ISUZU 4BG1T		Air Filter Secondary.....	A-5715	Oil Filter Full Flow.....	C-2702
Air Filter Secondary.....	A-7956	Coolant Filter.....	WC-5705	EX100WD-3 (EXCAVATORS) ISUZU 4BD1T	
Cabin Air Filter.....	CA-27040	Coolant Filter.....	WC-5713	Fuel Filter.....	FC-15031
Fuel Filter.....	FC-1005	Fuel Filter.....	FC-5702	Fuel Filter.....	FC-1824
Fuel Filter.....	FC-1801	Hydraulic Oil Filter.....	H-2730	Oil Filter Full Flow.....	C-6001
Fuel Filter.....	FC-1824	Hydraulic Oil Filter.....	H-5505	EX1200-5D (EXCAVATORS) CUMMINS QSK23 (S/N: 003001-UP)	
Hydraulic Oil Filter.....	H-2703	Oil Filter By Pass.....	C-5718	Air Filter Primary.....	A-5629
Hydraulic Oil Filter.....	H-2704	Oil Filter Full Flow.....	C-5715	Air Filter Secondary.....	A-5630
Oil Filter By Pass.....	C-15680	EX1900-5 (EXCAVATORS) MITSUBISHI S12A2-YTAA1		Air Filter Set.....	A-5629-S
Oil Filter Full Flow.....	C-2702	Air Filter.....	A-2715	Coolant Filter.....	WC-5703
Oil Filter Full Flow.....	C-6001	Air Filter Primary.....	A-5718	Fuel/Water Separator.....	SFC-5601-02
EX15 (EXCAVATORS) ISUZU 3KC1 , 1990		Air Filter Secondary.....	A-5715	Hydraulic Oil Filter.....	H-2703
Fuel Filter.....	F-5202	Fuel Filter.....	FC-1810	Hydraulic Oil Filter.....	H-2709
Hydraulic Oil Filter.....	H-2712	Fuel/Water Separator Primary.....	SF-1912-30	Hydraulic Oil Filter.....	HC-5602
Hydraulic Oil Filter.....	HC-5807	Hydraulic Oil Filter.....	H-2709	Hydraulic Oil Filter Suction.....	H-2706
Oil Filter Full Flow.....	C-1011	Hydraulic Oil Filter.....	HC-27100	Oil Filter Full Flow.....	C-5715
EX150 (EXCAVATORS) HITACHI 4BD1T , 1988		Oil Filter By Pass.....	C-5718	EX1200BE (EXCAVATORS)	
Air Filter Primary.....	A-2708	EX100WD (EXCAVATORS) ISUZU 6BB1		Air Filter Primary.....	A-5629
Air Filter Secondary.....	A-7956	Air Filter Primary.....	A-2708	Air Filter Secondary.....	A-5630
Air Filter Set.....	A-2711-S	Air Filter Secondary.....	A-7956	Air Filter Set.....	A-5629-S
Fuel Filter.....	FC-2702	Air Filter Set.....	A-2711-S	Fuel Filter.....	FC-1810
Hydraulic Oil Filter.....	H-2703	Fuel Filter.....	FC-1503	Hydraulic Oil Filter.....	H-2703
Hydraulic Oil Filter.....	H-2704	Fuel Filter.....	FC-15031	Hydraulic Oil Filter.....	H-2709
Hydraulic Oil Filter.....	H-2714	Hydraulic Oil Filter.....	H-2703	Hydraulic Oil Filter.....	HC-5602
Oil Filter Full Flow.....	C-2702	Hydraulic Oil Filter.....	H-2704	Hydraulic Oil Filter Suction.....	H-2706
EX150-5 (EXCAVATORS) ISUZU 4BG1T		Hydraulic Oil Filter.....	H-2714	EX122 (EXCAVATORS)	
Fuel Filter.....	FC-1801	Oil Filter Full Flow.....	C-2706	Air Filter Primary.....	A-2210
Hydraulic Oil Filter.....	H-2703	Oil Filter Full Flow.....	C-6001	Fuel Filter.....	F-1504
Hydraulic Oil Filter.....	H-2704	EX100WD (EXCAVATORS) ISUZU 6BBL		Oil Filter Full Flow.....	O-1506
Oil Filter By Pass.....	C-15680	Air Filter Primary.....	A-2708	EX130 (EXCAVATORS) KUBOTA	
Oil Filter Full Flow.....	C-2702	Air Filter Secondary.....	A-7956	Hydraulic Oil Filter.....	H-2719
EX15-2 (EXCAVATORS) KUBOTA D1105-B		Air Filter Set.....	A-2711-S	EX130H-5 (EXCAVATORS) ISUZU 4BG1T	
Hydraulic Oil Filter.....	H-2712	Fuel Filter.....	FC-1503	Cabin Air Filter.....	CA-27040
Hydraulic Oil Filter.....	HC-5807	Hydraulic Oil Filter.....	H-2703	Fuel Filter.....	FC-1005
EX16-2B (EXCAVATORS) KUBOTA D1105-B		Hydraulic Oil Filter.....	H-2704	Fuel Filter.....	FC-1801
Fuel Filter.....	F-5207	Hydraulic Oil Filter.....	H-2714	Hydraulic Oil Filter.....	H-2703
Hydraulic Oil Filter.....	H-2712	EX100WD-2 (EXCAVATORS) ISUZU 4BD1T		Hydraulic Oil Filter.....	H-2704
Hydraulic Oil Filter.....	HC-5807	Air Filter Secondary.....	A-7956	Oil Filter By Pass.....	C-15680
EX17-2 (EXCAVATORS) KUBOTA D1105-B		Fuel Filter.....	FC-1801	Oil Filter Full Flow.....	C-2702
Fuel Filter.....	F-5207	Fuel Filter.....	FC-1824	Oil Filter Full Flow.....	C-6001
Hydraulic Oil Filter.....	H-2712	Hydraulic Oil Filter.....	H-2703	EX135 (EXCAVATORS)	
Hydraulic Oil Filter.....	HC-5807	Hydraulic Oil Filter.....	H-2704	Fuel Filter.....	FC-5715
EX17-2B (EXCAVATORS) KUBOTA D1105-B		Oil Filter By Pass.....	C-15680	Hydraulic Oil Filter.....	H-2703
Fuel Filter.....	F-5207	Oil Filter Full Flow.....	C-2702	Hydraulic Oil Filter.....	H-2704
Hydraulic Oil Filter.....	H-2712	Oil Filter Full Flow.....	C-6001	EX135UR (EXCAVATORS) ISUZU 4BG1	
Hydraulic Oil Filter.....	HC-5807	EX100WD-3 (EXCAVATORS) ISUZU		Air Filter Primary.....	A-5541
EX17-2B (EXCAVATORS) KUBOTA D1105-B		Air Filter Secondary.....	A-7956	Air Filter Primary.....	A-5541M
Hydraulic Oil Filter.....	H-2712	Fuel Filter.....	FC-1503		

MODEL/APPLICATION	SAKURA NO	MODEL/APPLICATION	SAKURA NO	MODEL/APPLICATION	SAKURA NO
HITACHI		HITACHI		HITACHI	
EX135UR (EXCAVATORS) ISUZU 48G1		EX22 (EXCAVATORS) ISUZU 3KR1 , 1990		Air Filter Primary.....	A-5539
Air Filter Primary.....	A-76231	Air Filter Primary.....	AS-5643	Air Filter Primary.....	A-5539M
Air Filter Set.....	A-5541M-S	Air Filter Set.....	AS-5643-S	Air Filter Secondary.....	A-5538
Fuel Filter.....	FC-1801	Fuel Filter.....	F-5207	Air Filter Set.....	A-2709-S
Hydraulic Oil Filter.....	H-2703	Fuel Filter.....	FC-1006	Air Filter Set.....	A-2709M-S
Hydraulic Oil Filter.....	H-2704	Hydraulic Oil Filter.....	H-2719	Cabin Air Filter.....	CA-27040
Oil Filter By Pass.....	C-15680	Oil Filter Full Flow.....	C-1011	Fuel Filter.....	FC-1005
Oil Filter Full Flow.....	C-2702			Fuel Filter.....	FC-1503
		EX200 (EXCAVATORS) HITACHI 6BD1T , 1988		Fuel Filter.....	FC-15031
EX160WD (EXCAVATORS) ISUZU 6BB1		Air Filter Primary.....	A-5627	Hydraulic Oil Filter.....	H-2703
Air Filter Primary.....	A-2708	Air Filter Secondary.....	A-5408	Hydraulic Oil Filter Suction.....	H-2706
Air Filter Secondary.....	A-7956	Air Filter Secondary.....	A-6008	Oil Filter By Pass.....	C-1327
Air Filter Set.....	A-2711-S	Air Filter Set.....	A-5663-S	Oil Filter Full Flow.....	C-6001
Fuel Filter.....	FC-1503	Fuel Filter.....	FC-1503		
Fuel Filter.....	FC-15031	Hydraulic Oil Filter.....	H-2703	EX200-5 (EXCAVATORS) ISUZU A-6BG1T	
Hydraulic Oil Filter.....	H-2703	Hydraulic Oil Filter Suction.....	H-2706	Oil Filter Full Flow.....	C-2706
Hydraulic Oil Filter Suction.....	H-2706	Oil Filter By Pass.....	O-2701		
				EX200LC (EXCAVATORS)	
EX165 (EXCAVATORS) ISUZU 48G1		EX200 (EXCAVATORS) ISUZU 4BD1		Air Filter Primary.....	A-2706
Air Filter Secondary.....	A-7956	Fuel Filter.....	FC-15031	Air Filter Secondary.....	A-2705
Fuel Filter.....	FC-1801				
Hydraulic Oil Filter.....	H-2703	EX200 (EXCAVATORS) ISUZU 6BD1		EX200LC-5 (EXCAVATORS) ISUZU 6BG1T	
Hydraulic Oil Filter.....	H-2704	Fuel Filter.....	FC-15031	Fuel Filter.....	FC-15031
Hydraulic Oil Filter Suction.....	H-2706	Oil Filter Full Flow.....	C-6001		
Oil Filter Full Flow.....	C-2702			EX200LC-5 (EXCAVATORS) ISUZU 6BG1	
		EX200 (EXCAVATORS) ISUZU 6BD1T		Cabin Air Filter.....	CA-27040
EX165 (EXCAVATORS)		Fuel Filter.....	FC-15031	Fuel Filter.....	FC-15031
Air Filter Secondary.....	A-7956	Oil Filter Full Flow.....	C-6001	Oil Filter Full Flow.....	C-2706
Fuel Filter.....	FC-1801				
Hydraulic Oil Filter.....	H-2703	EX200 (EXCAVATORS) ISUZU 6B1T		EX220 (EXCAVATORS) HITACHI H06C-T	
Hydraulic Oil Filter.....	H-2704	Fuel Filter.....	FC-15031	Air Filter Primary.....	A-6006
Oil Filter By Pass.....	C-15680	Oil Filter Full Flow.....	C-6001	Air Filter Secondary.....	A-6007
Oil Filter Full Flow.....	C-2702			Air Filter Set.....	A-6118-S
		EX200-2 (EXCAVATORS) ISUZU 6BD1		Fuel Filter.....	FC-1503
EX165W (EXCAVATORS) CUMMINS 6BT5.9		Air Filter Primary.....	A-2706	Hydraulic Oil Filter.....	H-2703
Cabin Air Filter.....	CA-27040	Air Filter Secondary.....	A-2705	Hydraulic Oil Filter Suction.....	H-2706
		Fuel Filter.....	FC-1503	Oil Filter By Pass.....	O-2702
EX165W (EXCAVATORS) CUMMINS 6BT5.9-C		Fuel Filter.....	FC-15031		
Air Filter Primary.....	A-7954	Hydraulic Oil Filter.....	H-2703	EX220-2 (EXCAVATORS) HINO H06C-T	
Air Filter Secondary.....	A-7809	Hydraulic Oil Filter Suction.....	H-2706	Hydraulic Oil Filter.....	H-2727
Fuel Filter Secondary.....	FC-7903	Oil Filter By Pass.....	C-1327		
Fuel/Water Separator.....	SFC-5706			EX220-2 (EXCAVATORS) HITACHI H06C-T	
Hydraulic Oil Filter.....	H-2704	EX200-2 (EXCAVATORS) ISUZU 6BD1T		Air Filter Primary.....	A-5539
Oil Filter Full Flow.....	C-5704	Fuel Filter.....	FC-15031	Air Filter Primary.....	A-5539M
		Oil Filter Full Flow.....	C-6001	Air Filter Secondary.....	A-5538
EX150-1 (EXCAVATORS) ISUZU 48G1T				Air Filter Set.....	A-2709-S
Fuel Filter.....	FC-1824	EX200-3 (EXCAVATORS) ISUZU 6BD1		Air Filter Set.....	A-2709M-S
		Fuel Filter.....	FC-15031	Hydraulic Oil Filter.....	H-2703
EX100W (EXCAVATORS) ISUZU 6BB1		Oil Filter Full Flow.....	C-6001	Hydraulic Oil Filter Suction.....	H-2706
Fuel Filter.....	FC-15031			Oil Filter By Pass.....	C-1327
Oil Filter Full Flow.....	C-6001	EX200-3 (EXCAVATORS) ISUZU 6BD1T		Oil Filter Combination.....	C-1303
		Fuel Filter.....	FC-15031		
EX120-3 (EXCAVATORS) ISUZU 4BD1T		Oil Filter Full Flow.....	C-6001	EX220-5 (EXCAVATORS) HINO H07C-TD	
Fuel Filter.....	FC-15031			Air Filter Primary.....	A-5539
Oil Filter Full Flow.....	C-6001	EX200-5 (EXCAVATORS) ISUZU 6BG1		Air Filter Primary.....	A-5539M
		Fuel Filter.....	FC-15031	Air Filter Secondary.....	A-5538
		Oil Filter Full Flow.....	C-6001	Air Filter Set.....	A-2709-S
				Air Filter Set.....	A-2709M-S

MODEL/APPLICATION	SAKURA NO	MODEL/APPLICATION	SAKURA NO	MODEL/APPLICATION	SAKURA NO
HITACHI		HITACHI		HITACHI	
EX220-5 (EXCAVATORS) HINO H07C-TD		Air Filter Set.....	A-2709M-S	Air Filter Secondary.....	A-7809
Cabin Air Filter.....	CA-27040	Fuel Filter.....	FC-1503	Air Filter Set.....	AS-2212-S
Fuel Filter.....	FC-1005	Fuel Filter.....	FC-15031	Fuel Filter.....	FC-2202
Hydraulic Oil Filter.....	H-2703	Hydraulic Oil Filter.....	H-2703	Hydraulic Oil Filter.....	H-2703
Hydraulic Oil Filter Suction.....	H-2706	Hydraulic Oil Filter Suction.....	H-2706	Hydraulic Oil Filter Suction.....	H-2706
Oil Filter By Pass.....	C-1327	Oil Filter By Pass.....	C-1327	Oil Filter Combination.....	C-7937
Oil Filter Combination.....	C-1303				
EX220-5 (EXCAVATORS) HINO H07CT		EX255 (EXCAVATORS) ISUZU 6BG1		EX225USR (EXCAVATORS) ISUZU 6BG1T	
Hydraulic Oil Filter.....	H-2727	Fuel Filter.....	FC-15031	Air Filter Primary.....	A-5539
				Air Filter Primary.....	A-5539M
EX22-2 (EXCAVATORS) KUBOTA D1105-B		EX270 (EXCAVATORS) CUMMINS		Air Filter Secondary.....	A-5538
Air Filter Primary.....	AS-5643	Air Filter Primary.....	AS-7621	Air Filter Set.....	A-2709-S
Air Filter Set.....	AS-5643-S	Air Filter Secondary.....	A-7619	Air Filter Set.....	A-2709M-S
Fuel Filter.....	F-5207	Air Filter Set.....	AS-7622-S	Fuel Filter.....	FC-1503
Hydraulic Oil Filter.....	H-2712	Fuel Filter Secondary.....	FC-7903	Hydraulic Oil Filter.....	H-2703
		Fuel/Water Separator.....	SFC-5706	Hydraulic Oil Filter Suction.....	H-2706
EX2500 (EXCAVATORS) CUMMINS KTA50		Hydraulic Oil Filter.....	H-2703	Oil Filter By Pass.....	C-1327
Hydraulic Oil Filter.....	HC-27100	Oil Filter Combination.....	C-5723		
EX2500 (EXCAVATORS) CUMMINS KTA25C		EX270 (EXCAVATORS) HINO H06C-T		EX225USR (EXCAVATORS) ISUZU 6BG1	
Air Filter.....	A-2715	Fuel Filter.....	FC-15031	Fuel Filter.....	FC-15031
Air Filter Secondary.....	A-7902				
Coolant Filter.....	WC-5712	EX270 (EXCAVATORS) HITACHI H06C-T		EX230LC-5 (EXCAVATORS) HINO H07C-TD	
Fuel/Water Separator.....	SFC-5707	Air Filter Primary.....	A-6006	Air Filter Primary.....	A-5539
Hydraulic Oil Filter.....	H-2709	Air Filter Secondary.....	A-6007	Air Filter Primary.....	A-5539M
Hydraulic Oil Filter.....	H-2730	Air Filter Set.....	A-6118-S	Air Filter Secondary.....	A-5538
Oil Filter By Pass.....	C-5718	Hydraulic Oil Filter.....	H-2703	Air Filter Set.....	A-2709-S
Oil Filter Full Flow.....	C-5715	Hydraulic Oil Filter Suction.....	H-2706	Air Filter Set.....	A-2709M-S
		Oil Filter By Pass.....	O-2702	Fuel Filter.....	FC-1005
EX25-2 (EXCAVATORS) KUBOTA D1105-B		EX27U (EXCAVATORS) ISUZU 3LD1		Hydraulic Oil Filter.....	H-2703
Air Filter Primary.....	AS-5643	Air Filter Primary.....	A-8513	Hydraulic Oil Filter Suction.....	H-2706
Air Filter Set.....	AS-5643-S	Hydraulic Oil Filter.....	H-2712	Oil Filter By Pass.....	C-1327
Fuel Filter.....	F-5207			Oil Filter Combination.....	C-1303
Hydraulic Oil Filter.....	H-2712	EX29UE (EXCAVATORS) ISUZU 3LD1			
		Air Filter Primary.....	A-8513	EX235 (EXCAVATORS)	
EX255 (EXCAVATORS) CUMMINS		Hydraulic Oil Filter.....	H-2712	Air Filter Primary.....	AS-2212
Air Filter Primary.....	AS-7621	EX2500-5 (EXCAVATORS) CUMMINS QSK45		Air Filter Secondary.....	A-7809
Air Filter Secondary.....	A-7619	Hydraulic Oil Filter.....	HC-27100	Air Filter Set.....	AS-2212-S
Air Filter Set.....	AS-7622-S			Fuel Filter.....	FC-2202
Coolant Filter.....	WC-5703	EX210H-5 (EXCAVATORS) ISUZU 6BG1		Hydraulic Oil Filter.....	H-2703
Coolant Filter.....	WC-5713	Air Filter Primary.....	A-5539	Oil Filter Combination.....	C-7937
Fuel Filter.....	FS-5701	Air Filter Primary.....	A-5539M		
Fuel Filter Secondary.....	FC-7903	Air Filter Secondary.....	A-5538	EX285 (EXCAVATORS) CUMMINS	
Fuel/Water Separator.....	SFC-5706	Air Filter Set.....	A-2709-S	Air Filter Primary.....	AS-7621
Hydraulic Oil Filter.....	H-2703	Air Filter Set.....	A-2709M-S	Air Filter Secondary.....	A-7619
Hydraulic Oil Filter Suction.....	H-2706	Air Filter Set.....	A-2709-S	Air Filter Set.....	AS-7622-S
		Cabin Air Filter.....	CA-27040	Coolant Filter.....	WC-5703
EX255 (EXCAVATORS) CUMMINS 6CT8.3		Fuel Filter.....	FC-1503	Coolant Filter.....	WC-5713
Hydraulic Oil Filter.....	H-2727	Fuel Filter.....	FC-15031	Fuel Filter Secondary.....	FC-7903
		Hydraulic Oil Filter.....	H-2703	Fuel/Water Separator.....	SFC-5706
EX255 (EXCAVATORS) ISUZU 6BG1T		Hydraulic Oil Filter Suction.....	H-2706	Hydraulic Oil Filter.....	H-2703
Air Filter Primary.....	A-5539	Oil Filter By Pass.....	C-1327	Hydraulic Oil Filter Suction.....	H-2706
Air Filter Primary.....	A-5539M				
Air Filter Secondary.....	A-5538	EX215 (EXCAVATORS) IVECO		EX285 (EXCAVATORS) ISUZU 6BG1T	
Air Filter Set.....	A-2709-S	Air Filter Primary.....	AS-2212	Fuel Filter.....	FC-15031

MODEL/APPLICATION	SAKURA NO	MODEL/APPLICATION	SAKURA NO	MODEL/APPLICATION	SAKURA NO
HITACHI		HITACHI		HITACHI	
EX285 (EXCAVATORS) ISUZU 6BG1		Air Filter Set.....	A-1841-S	Hydraulic Oil Filter.....	H-2705
Fuel Filter.....	FC-15031	Fuel Filter.....	FC-1005	EX35U (EXCAVATORS) ISUZU 3LD1	
Hydraulic Oil Filter.....	H-2727	Fuel Filter.....	FC-1503	Air Filter Primary.....	A-8513
		Fuel Filter.....	FC-15031	Fuel Filter.....	F-5207
EX285 (EXCAVATORS) ISUZU 6BG1-TRA06 (S/N: TIER 2-UP)		Hydraulic Oil Filter.....	H-2703	Hydraulic Oil Filter.....	H-2705
Air Filter Primary.....	A-5539	Hydraulic Oil Filter Suction.....	H-2706	Hydraulic Oil Filter.....	H-2712
Air Filter Primary.....	A-5539M	Oil Filter By Pass.....	C-1327		
Air Filter Secondary.....	A-5538	Oil Filter Full Flow.....	C-5505	EX3600-5 (EXCAVATORS) ISUZU	
Air Filter Set.....	A-2709-S			Air Filter.....	A-2715
Air Filter Set.....	A-2709M-S	EX300-3 (EXCAVATORS) ISUZU 6SD1T		Air Filter Primary.....	A-5718
Fuel Filter.....	FC-1503	Air Filter Primary.....	A-1013	Air Filter Secondary.....	A-5715
Hydraulic Oil Filter.....	H-2703	Air Filter Primary.....	A-10134	Fuel Filter.....	FC-1501
Hydraulic Oil Filter Suction.....	H-2706	Air Filter Secondary.....	A-5631	Hydraulic Oil Filter.....	H-2709
Oil Filter By Pass.....	C-1327	Air Filter Set.....	A-1841-S	Hydraulic Oil Filter.....	H-2730
		Fuel Filter.....	FC-1005	Hydraulic Oil Filter.....	HC-69031
EX29U (EXCAVATORS)		Fuel Filter.....	FC-2703	Oil Filter By Pass.....	C-5718
Air Filter Primary.....	A-8513	Hydraulic Oil Filter.....	H-2703	Oil Filter Full Flow.....	C-1511
Fuel Filter.....	F-5207	Hydraulic Oil Filter Suction.....	H-2706	Oil Filter Full Flow.....	C-1538
Hydraulic Oil Filter.....	H-2712	Oil Filter By Pass.....	C-1327		
		Oil Filter Full Flow.....	C-5505	EX36UE (EXCAVATORS) ISUZU 3LD1	
EX210LCH-5 (EXCAVATORS) ISUZU 6BG1				Air Filter Primary.....	A-8513
Cabin Air Filter.....	CA-27040	EX300-5 (EXCAVATORS)		Fuel Filter.....	F-5207
Fuel Filter.....	FC-15031	Air Filter Primary.....	A-28710	Hydraulic Oil Filter.....	H-2705
Oil Filter Full Flow.....	C-2706	Air Filter Secondary.....	A-7967	Hydraulic Oil Filter.....	H-2712
		Air Filter Set.....	A-28730-S		
EX200-1 (EXCAVATORS) ISUZU 6BD1T		Fuel Filter.....	FC-1005	EX300 (EXCAVATORS) HITACHI EP100T	
Fuel Filter.....	FC-15031	Fuel Filter.....	FC-2703	Air Filter Primary.....	A-1313
Oil Filter Full Flow.....	C-6001	Hydraulic Oil Filter.....	H-2703	Air Filter Secondary.....	A-1307
		Oil Filter By Pass.....	C-1327	Air Filter Set.....	A-5662-S
EX210LC-5 (EXCAVATORS) ISUZU 6BG1		Oil Filter Full Flow.....	C-5505	Hydraulic Oil Filter.....	H-2703
Fuel Filter.....	FC-15031			Hydraulic Oil Filter Suction.....	H-2706
		EX300-LC (EXCAVATORS) 1993		Oil Filter By Pass.....	O-2702
EX35 (EXCAVATORS) ISUZU 3KR2 , 1991		Air Filter Primary.....	A-1313	EX300LC-5 (EXCAVATORS) ISUZU 6SD1 TQA01	
Air Filter Primary.....	AS-5643	Air Filter Secondary.....	A-1307	Air Filter Primary.....	A-28710
Air Filter Set.....	AS-5643-S	Air Filter Set.....	A-5662-S	Air Filter Secondary.....	A-7967
Fuel Filter.....	F-5207	Fuel Filter.....	FC-5720	Air Filter Set.....	A-28730-S
Fuel Filter.....	FC-1006	Hydraulic Oil Filter.....	H-2703	Fuel Filter.....	FC-1005
Hydraulic Oil Filter.....	H-2719	Oil Filter By Pass.....	O-2702	Fuel Filter.....	FC-2703
Oil Filter Full Flow.....	C-1011			Hydraulic Oil Filter.....	H-2703
		EX30-2 (EXCAVATORS) KUBOTA V1505 , 1992		Hydraulic Oil Filter Suction.....	H-2706
EX355 - TIER 2 (EXCAVATORS) ISUZU 6HK1-XQA01		Air Filter Primary.....	AS-5643	Oil Filter By Pass.....	C-1327
Air Filter Primary.....	AS-5102	Air Filter Set.....	AS-5643-S	Oil Filter Full Flow.....	C-5505
Air Filter Set.....	AS-5102-S	Fuel Filter.....	F-5207		
		Hydraulic Oil Filter.....	H-2712	EX310H-3C (EXCAVATORS) ISUZU 6SD1T	
EX30 (EXCAVATORS) ISUZU 3KR2 (S/N: HA03-UP)				Air Filter Primary.....	A-1013
Air Filter Primary.....	AS-5643	EX30U (EXCAVATORS) ISUZU 3LD1		Air Filter Primary.....	A-10134
Air Filter Set.....	AS-5643-S	Air Filter Primary.....	A-8513	Air Filter Secondary.....	A-5631
Fuel Filter.....	F-5207	Fuel Filter.....	F-5207	Air Filter Set.....	A-1841-S
Fuel Filter.....	FC-1006	Hydraulic Oil Filter.....	H-2705	Fuel Filter.....	FC-1005
Hydraulic Oil Filter.....	H-2719	Hydraulic Oil Filter.....	H-2712	Fuel Filter.....	FC-2703
Oil Filter Full Flow.....	C-1011			Hydraulic Oil Filter.....	H-2703
		EX32UE (EXCAVATORS) ISUZU 3LD1 , 2003		Hydraulic Oil Filter Suction.....	H-2706
EX300-2 (EXCAVATORS) ISUZU 6SD1T		Air Filter Primary.....	A-8513	Oil Filter By Pass.....	C-1327
Air Filter Primary.....	A-1013	Fuel Filter.....	F-5207	Oil Filter Full Flow.....	C-5505
Air Filter Primary.....	A-10134	Hydraulic Oil Filter.....	H-2712		
Air Filter Secondary.....	A-5631			EX3500 (EXCAVATORS) HITACHI KT38C	

Sakura Filter

ENGINE APPLICATION

MODEL/APPLICATION	SAKURA NO	MODEL/APPLICATION	SAKURA NO	MODEL/APPLICATION	SAKURA NO
HITACHI		HITACHI		HITACHI	
EX3500 (EXCAVATORS) HITACHI KT38C		EX40 (EXCAVATORS) KUBOTA V1505TE		Fuel Filter..... FC-2703	
Air Filter.....	A-2715	Fuel Filter.....	FC-15031	Hydraulic Oil Filter.....	H-2703
Air Filter Primary.....	A-5718	Hydraulic Oil Filter..... H-2709			
Air Filter Secondary.....	A-5715	Oil Filter By Pass..... C-1327			
Coolant Filter.....	WC-5711	EX450-5 (EXCAVATORS) w/Isuzu 6RB1T Eng.			
Fuel/Water Separator.....	SFC-5707	Air Filter Set..... A-13092-S			
Hydraulic Oil Filter.....	H-2730	EX455 (EXCAVATORS) ISUZU 6RB1T			
Hydraulic Oil Filter.....	H-5505	Air Filter Primary..... A-6010			
Hydraulic Oil Filter.....	HC-5602	Air Filter Secondary..... A-6011			
Oil Filter By Pass.....	C-5718	Fuel Filter..... FC-1005			
Oil Filter Full Flow.....	C-5715	Fuel Filter..... FC-2703			
EX350H-5 (EXCAVATORS) ISUZU 6SD1 TQA01		EX400-3 (EXCAVATORS) ISUZU 6RB1-TPQ		Hydraulic Oil Filter..... H-2703	
Air Filter Primary.....	A-28710	Air Filter Secondary.....	A-5408	Hydraulic Oil Filter.....	H-2727
Air Filter Secondary.....	A-7967	Fuel Filter.....	FC-1005	Oil Filter By Pass.....	C-1327
Air Filter Set.....	A-28730-S	Fuel Filter.....	FC-2703	EX455 (EXCAVATORS) w/Isuzu 6RB1T Eng.	
Fuel Filter.....	FC-1005	Hydraulic Oil Filter.....	H-2703	Air Filter Set..... A-13092-S	
Fuel Filter.....	FC-2703	Hydraulic Oil Filter.....	H-2709	EX455-5 (EXCAVATORS) ISUZU 6RB1T	
Hydraulic Oil Filter.....	H-2703	Oil Filter Full Flow.....	C-1312	Air Filter Primary..... A-6113	
Hydraulic Oil Filter Suction.....	H-2706	EX400-5 (EXCAVATORS) ISUZU 6RB1T			
Oil Filter By Pass.....	C-1327	Cabin Air Filter..... CA-27040			
Oil Filter Full Flow.....	C-5505	EX400-5 (EXCAVATORS)			
EX355 (EXCAVATORS) ISUZU 6HK1-XQA01 (S/N: TIER 2-UP)		Air Filter Primary.....		Air Filter Primary..... A-6113	
Air Filter Primary.....	AS-5102	Air Filter Secondary.....		Air Filter Secondary..... A-5408	
Air Filter Secondary.....	A-8651	Fuel Filter.....		Fuel Filter..... FC-1005	
Air Filter Set.....	AS-5102-S	Fuel Filter.....		Fuel Filter..... FC-2703	
Fuel Filter.....	FC-2703	Hydraulic Oil Filter.....		Hydraulic Oil Filter..... H-2703	
Hydraulic Oil Filter.....	H-2703	Hydraulic Oil Filter.....		Hydraulic Oil Filter..... H-2709	
Hydraulic Oil Filter Suction.....	H-2706	Hydraulic Oil Filter.....		Oil Filter By Pass..... C-1327	
EX355 (EXCAVATORS) ISUZU 6SD1-TQA03		Hydraulic Oil Filter.....		Hydraulic Oil Filter..... HC-7901	
Air Filter Primary.....	A-28710	Oil Filter By Pass.....		C-1327	
Air Filter Secondary.....	A-7967	EX40-2 (EXCAVATORS) KUBOTA V2203-B			
Air Filter Set.....	A-28730-S	Air Filter Primary..... AS-5643			
Fuel Filter.....	FC-2703	Air Filter Set..... AS-5643-S			
Hydraulic Oil Filter.....	H-2703	Fuel Filter..... F-5210			
Hydraulic Oil Filter Suction.....	H-2706	Hydraulic Oil Filter..... H-2712			
Oil Filter By Pass.....	C-1327	EX40UR (EXCAVATORS) ISUZU			
Oil Filter Full Flow.....	C-5505	Air Filter Primary..... AS-5643			
EX370-5 (EXCAVATORS) ISUZU 6SD1 TQA01		Air Filter Set..... AS-5643-S			
Air Filter Primary.....	A-28710	Fuel Filter..... F-5207			
Air Filter Secondary.....	A-7967	Hydraulic Oil Filter..... H-2719			
Air Filter Set.....	A-28730-S	Oil Filter Full Flow..... C-1011			
Fuel Filter.....	FC-1005	EX455-2 (EXCAVATORS)			
Fuel Filter.....	FC-2703	Air Filter Primary..... A-6010			
Hydraulic Oil Filter.....	H-2703	Air Filter Secondary..... A-6011			
Hydraulic Oil Filter Suction.....	H-2706	Fuel Filter..... FC-2703			
Oil Filter By Pass.....	C-1327	Hydraulic Oil Filter..... H-2703			
Oil Filter Full Flow.....	C-5505	Hydraulic Oil Filter..... HC-7901			
EX40 (EXCAVATORS) ISUZU 4JC1 , 1991		EX50UR (EXCAVATORS) 3AB1			
Air Filter Primary.....	AS-5643	Hydraulic Oil Filter..... H-2705			
Air Filter Set.....	AS-5643-S	EX50UR (EXCAVATORS) ISUZU 3AB1			
Hydraulic Oil Filter.....	H-2719	Fuel Filter..... FC-1801			
EX450-5 (EXCAVATORS) ISUZU 6RB1T		Fuel Filter..... FC-1824			
Air Filter Primary.....	A-6113	Hydraulic Oil Filter..... H-2703			
Air Filter Secondary.....	A-5408	EX550 (EXCAVATORS) CUMMINS N14			
Fuel Filter.....	FC-1005	Cabin Air Filter..... CA-27040			

MODEL/APPLICATION	SAKURA NO	MODEL/APPLICATION	SAKURA NO	MODEL/APPLICATION	SAKURA NO
HITACHI		HITACHI		HITACHI	
EX550 (EXCAVATORS) CUMMINS NTA-855		Air Filter Set.....	AS-5643-S	Hydraulic Oil Filter.....	H-2705
Air Filter Primary.....	A-6010	Fuel Filter.....	FC-1801	EX60-5 (EXCAVATORS) NISSAN BD3004	
Air Filter Secondary.....	A-6011	Hydraulic Oil Filter.....	H-2719	Cabin Air Filter.....	CA-27040
Coolant Filter.....	WC-5712	EX55UR-3 (EXCAVATORS) ISUZU 4LE1		Hydraulic Oil Filter.....	H-2705
Fuel/Water Separator.....	SFC-5705	Air Filter Primary.....	A-8513	EX60-5 (EXCAVATORS) NISSAN BD3004-19	
Hydraulic Oil Filter.....	H-2703	Air Filter Secondary.....	A-5569	Air Filter Primary.....	A-8505
Hydraulic Oil Filter.....	H-2709	Fuel Filter.....	F-5207	Air Filter Secondary.....	A-8599
Oil Filter Combination.....	C-5723	Hydraulic Oil Filter.....	H-2712	Fuel Filter.....	FC-1801
EX550 (EXCAVATORS) CUMMINS N14-C400		EX5500-6 (EXCAVATORS) CUMMINS QSK50		Hydraulic Oil Filter.....	H-2703
Air Filter Primary.....	A-6010	Hydraulic Oil Filter.....	HC-27100	EX60UR (EXCAVATORS) ISUZU 4J81 , 1990	
Air Filter Secondary.....	A-6011	EX5600-6 (EXCAVATORS) CUMMINS QSK50-C		Air Filter Primary.....	AS-1014
Coolant Filter.....	WC-5712	Hydraulic Oil Filter.....	HC-27100	Fuel Filter.....	FC-1801
Fuel/Water Separator.....	SFC-5705	EX60 (EXCAVATORS) HITACHI FD3304 , 1988		Hydraulic Oil Filter.....	H-2703
Hydraulic Oil Filter.....	H-2703	Air Filter Primary.....	AS-1014	EX60UR (EXCAVATORS) ISUZU 4J81	
Hydraulic Oil Filter.....	H-2709	Fuel Filter.....	FC-1801	Hydraulic Oil Filter.....	H-2705
Oil Filter Combination.....	C-5723	Hydraulic Oil Filter.....	H-2703	EX60URG (EXCAVATORS) ISUZU 4J81	
EX550 (EXCAVATORS) w/Cummins N14 Eng		Hydraulic Oil Filter.....	H-2714	Hydraulic Oil Filter.....	H-2705
Air Filter Set.....	A-13092-S	EX60 (EXCAVATORS) HITACHI FD3302		EX60WD (EXCAVATORS) HITACHI FD3304 , 1990	
EX550-3 (EXCAVATORS) CUMMINS N14		Air Filter Primary.....	AS-1014	Air Filter Primary.....	AS-1014
Cabin Air Filter.....	CA-27040	EX60 (EXCAVATORS) NISSAN FD3304		Fuel Filter.....	FC-1801
EX550-3 (EXCAVATORS) w/Cummins N14 Eng		Hydraulic Oil Filter.....	H-2705	Hydraulic Oil Filter.....	H-2703
Air Filter Set.....	A-13092-S	EX600-3 (EXCAVATORS) CUMMINS N14		Hydraulic Oil Filter.....	H-2714
EX550-5 (EXCAVATORS) CUMMINS N14		Cabin Air Filter.....	CA-27040	EX60WD (EXCAVATORS) ISUZU 4BD1	
Cabin Air Filter.....	CA-27040	EX600-3 (EXCAVATORS) CUMMINS N14-C400		Hydraulic Oil Filter.....	H-2705
EX550-5 (EXCAVATORS) CUMMINS N14-C400		Air Filter Primary.....	A-6010	EX60WD (EXCAVATORS) NISSAN FD3304	
Air Filter Primary.....	A-6010	Air Filter Secondary.....	A-6011	Hydraulic Oil Filter.....	H-2705
Air Filter Secondary.....	A-6011	Coolant Filter.....	WC-5712	EX60WD-2 (EXCAVATORS) HITACHI BD3004 , 1992	
Coolant Filter.....	WC-5712	Fuel/Water Separator.....	SFC-5705	Air Filter Primary.....	A-8505
Fuel/Water Separator.....	SFC-5705	Hydraulic Oil Filter.....	H-2703	Fuel Filter.....	FC-1801
Hydraulic Oil Filter.....	H-2703	Hydraulic Oil Filter.....	H-2709	Hydraulic Oil Filter.....	H-2703
Hydraulic Oil Filter.....	H-2709	Oil Filter Combination.....	C-5723	Hydraulic Oil Filter.....	H-2714
Oil Filter Combination.....	C-5723	EX600-3 (EXCAVATORS) w/Cummins N14 Eng		EX60WD-2 (EXCAVATORS) NISSAN BD3004	
EX550-5 (EXCAVATORS) w/Cummins N14 Eng		Air Filter Set.....	A-13092-S	Hydraulic Oil Filter.....	H-2705
Air Filter Set.....	A-13092-S	EX60-2 (EXCAVATORS) HITACHI BD3004 , 1992		EX600 (EXCAVATORS)	
EX5500-5 (EXCAVATORS) CUMMINS QSK45-C , 2005		Air Filter Primary.....	A-8505	Air Filter Primary.....	A-6010
Air Filter.....	A-2715	Air Filter Secondary.....	A-8599	Air Filter Secondary.....	A-6011
Air Filter Secondary.....	A-7902	Fuel Filter.....	FC-1801	Coolant Filter.....	WC-5712
Coolant Filter.....	WC-5703	Hydraulic Oil Filter.....	H-2703	Fuel Filter.....	FC-2703
Fuel/Water Separator.....	SFC-5601-02	EX60-2 (EXCAVATORS) NISSAN BD3004		Hydraulic Oil Filter.....	H-2703
Hydraulic Oil Filter.....	H-2709	Hydraulic Oil Filter.....	H-2705	Hydraulic Oil Filter.....	H-2709
Hydraulic Oil Filter.....	H-2730	EX60-2 (EXCAVATORS) NISSAN BD3004-19		EX600H-5 (EXCAVATORS) CUMMINS N14	
EX5500-5 (EXCAVATORS) CUMMINS QSK45-C		Fuel Filter.....	FC-1824	Cabin Air Filter.....	CA-27040
Hydraulic Oil Filter.....	HC-27100	EX60-3 (EXCAVATORS) NISSAN BD3004			
EX55UR (EXCAVATORS) NISSAN TD2340-10		Air Filter Primary.....	AS-5643		
Air Filter Primary.....	AS-5643				

MODEL/APPLICATION	SAKURA NO	MODEL/APPLICATION	SAKURA NO	MODEL/APPLICATION	SAKURA NO
HITACHI		HITACHI		HITACHI	
EX600H-5 (EXCAVATORS) CUMMINS N14-C400		EX600LCH-5 (EXCAVATORS) w/Cummins N14 Eng		EX75UR-3 (EXCAVATORS) NISSAN BD3004-20	
Air Filter Primary.....	A-6010	Air Filter Set.....	A-13092-S	Air Filter Primary.....	A-8505
Air Filter Secondary.....	A-6011			Fuel Filter.....	FC-1801
Coolant Filter.....	WC-5712	EX60-1 (EXCAVATORS) NISSAN FD3304		Hydraulic Oil Filter.....	H-2703
Fuel/Water Separator.....	SFC-5705	Hydraulic Oil Filter.....	H-2705		
Hydraulic Oil Filter.....	H-2703	EX60LC-5 (EXCAVATORS) NISSAN BD3004		EX75US-7 (EXCAVATORS) ISUZU 4JB1	
Hydraulic Oil Filter.....	H-2709	Cabin Air Filter.....	CA-27040	Hydraulic Oil Filter.....	H-2705
Oil Filter Combination.....	C-5723	Hydraulic Oil Filter.....	H-2705		
EX600H-5 (EXCAVATORS) w/Cummins N14 Eng		EX60WD-1 (EXCAVATORS) NISSAN FD3304		EX75US-7 (EXCAVATORS) ISUZU 4JG1	
Air Filter Set.....	A-13092-S	Hydraulic Oil Filter.....	H-2705	Air Filter Primary.....	A-8505
EX60SR (EXCAVATORS) HITACHI FD3304		EX700 (EXCAVATORS) CUMMINS NTA-855 , 1995		Air Filter Secondary.....	A-8599
Air Filter Primary.....	AS-1014	Air Filter Primary.....	A-5629	Fuel Filter.....	FC-1801
Hydraulic Oil Filter.....	H-2703	Air Filter Secondary.....	A-5630	Hydraulic Oil Filter.....	H-2703
Hydraulic Oil Filter.....	H-2714	Air Filter Set.....	A-5629-S		
EX60SR (EXCAVATORS) NISSAN FD3304		Cabin Air Filter.....	CA-56041	EX800 (EXCAVATORS)	
Hydraulic Oil Filter.....	H-2705	Coolant Filter.....	WC-5713	Air Filter Primary.....	A-5629
EX600H-3 (EXCAVATORS) CUMMINS N14		Fuel Filter.....	FC-5702	Air Filter Secondary.....	A-5630
Cabin Air Filter.....	CA-27040	Hydraulic Oil Filter.....	H-2703	Air Filter Set.....	A-5629-S
EX600H-3 (EXCAVATORS) w/Cummins N14 Eng		Oil Filter Combination.....	C-5723	Coolant Filter.....	WC-5712
Air Filter Set.....	A-13092-S	EX700 (EXCAVATORS) CUMMINS NTA855B		Fuel Filter.....	FC-2703
EX600LC-3 (EXCAVATORS) CUMMINS N14		Hydraulic Oil Filter.....	HC-27100	Hydraulic Oil Filter.....	H-2703
Cabin Air Filter.....	CA-27040	EX750 (EXCAVATORS) CUMMINS N14 SERIES		Hydraulic Oil Filter.....	HC-7901
EX600LC-3 (EXCAVATORS) w/Cummins N14 Eng		Air Filter Primary.....	A-6010	Oil Filter Combination.....	C-5723
Air Filter Set.....	A-13092-S	Air Filter Secondary.....	A-6011	EX800-5 (EXCAVATORS)	
EX600LCH-3 (EXCAVATORS) CUMMINS N14		Coolant Filter.....	WC-5712	Air Filter Primary.....	A-5629
Cabin Air Filter.....	CA-27040	Fuel/Water Separator.....	SFC-5705	Air Filter Secondary.....	A-5630
EX600LCH-3 (EXCAVATORS) w/Cummins N14 Eng		Hydraulic Oil Filter.....	H-2703	Air Filter Set.....	A-5629-S
Air Filter Set.....	A-13092-S	Hydraulic Oil Filter.....	H-2709	Coolant Filter.....	WC-5712
EX600-5 (EXCAVATORS) CUMMINS N14		Oil Filter Combination.....	C-5723	Fuel/Water Separator.....	SFC-5705
Cabin Air Filter.....	CA-27040	EX750-5 (EXCAVATORS) CUMMINS N14-C		Hydraulic Oil Filter.....	H-2703
EX600-5 (EXCAVATORS) w/Cummins N14 Eng		Air Filter Primary.....	A-5629	Hydraulic Oil Filter.....	HC-7901
Air Filter Set.....	A-13092-S	Air Filter Secondary.....	A-5630	Oil Filter Combination.....	C-5723
EX600LC-5 (EXCAVATORS) CUMMINS N14		Air Filter Set.....	A-5629-S	EX8000 (EXCAVATORS) HITACHI , 2005	
Cabin Air Filter.....	CA-27040	Cabin Air Filter.....	CA-27040	Air Filter Secondary.....	A-7902
EX600LC-5 (EXCAVATORS) w/Cummins N14 Eng		Coolant Filter.....	WC-5712	Coolant Filter.....	WC-5703
Air Filter Set.....	A-13092-S	Fuel/Water Separator.....	SFC-5705	Coolant Filter.....	WC-5713
EX600LCH-5 (EXCAVATORS) CUMMINS N14		Hydraulic Oil Filter.....	H-2703	Fuel Filter.....	FC-1501
Cabin Air Filter.....	CA-27040	Hydraulic Oil Filter.....	HC-7901	Fuel Filter.....	FC-57290
EX600LCH-5 (EXCAVATORS) w/Cummins N14 Eng		Oil Filter Combination.....	C-5723	Hydraulic Oil Filter.....	H-2709
Air Filter Set.....	A-13092-S	EX75UR (EXCAVATORS)		Hydraulic Oil Filter.....	H-2730
EX600LCH-5 (EXCAVATORS) CUMMINS N14		Air Filter Primary.....	A-8505	EX8000 (EXCAVATORS) MITSUBISHI S16RY1TAA22EA	
Cabin Air Filter.....	CA-27040	Fuel Filter.....	FC-1801	Hydraulic Oil Filter.....	HC-27100
EX600LCH-5 (EXCAVATORS) w/Cummins N14 Eng		Hydraulic Oil Filter.....	H-2703	EX800H-5 (EXCAVATORS) CUMMINS N14-C	
Air Filter Set.....	A-13092-S	Hydraulic Oil Filter.....	H-2705	Air Filter Primary.....	A-5629
EX600LCH-5 (EXCAVATORS) CUMMINS N14		EX75UR-3 (EXCAVATORS) NISSAN BD3004		Air Filter Secondary.....	A-5630
Cabin Air Filter.....	CA-27040	Hydraulic Oil Filter.....	H-2705	Air Filter Set.....	A-5629-S

MODEL/APPLICATION	SAKURA NO	MODEL/APPLICATION	SAKURA NO	MODEL/APPLICATION	SAKURA NO
HITACHI		HITACHI		HITACHI	
FR70 (LOADERS)		Hydraulic Oil Filter.....	H-7911	Air Filter.....	AS-5707
Air Filter Primary.....	AS-7609	Oil Filter By Pass.....	0-1804	Fuel Filter.....	F-1303
Air Filter Secondary.....	A-7605	KH150-3 (CRANES)		KH300-3 (CRANES)	
Fuel Filter.....	FC-5715	HINO H06CT (S/N: 911-UP)		ISUZU 6RB1	
Hydraulic Oil Filter.....	HC-7913	Air Filter Primary.....	A-6006	Air Filter.....	AS-5707
Oil Filter Full Flow.....	C-7917	Air Filter Set.....	A-6118-S	Air Filter Primary.....	A-6006
FR90 (LOADERS)		Hydraulic Oil Filter.....	H-2719	Air Filter Set.....	A-6118-S
IVECO		Oil Filter By Pass.....	0-2702	Fuel Filter.....	F-1504
Air Filter Primary.....	AS-7805	KH150-3 (CRANES)		Fuel Filter.....	FC-2703
Air Filter Secondary.....	A-7964	HITACHI BF10L513		Hydraulic Oil Filter.....	H-2719
Air Filter Set.....	AS-5656-S	Air Filter Primary.....	A-5301	Oil Filter Full Flow.....	C-1312
Fuel Filter.....	FC-5715	Hydraulic Oil Filter.....	H-2719	Oil Filter Full Flow.....	0-1506
Hydraulic Oil Filter.....	HC-7913	Oil Filter Full Flow.....	C-6204	KH500 (CRANES)	
Oil Filter Combination.....	C-7937	KH150-3 (CRANES)		ISUZU 12PB1	
EX5500 (EXCAVATORS)		HITACHI EM100 (S/N: T0-910)		Air Filter.....	AS-5707
CUMMINS KTA50		Air Filter Primary.....	A-6006	Fuel Filter.....	F-1503
Hydraulic Oil Filter.....	HC-27100	Air Filter Set.....	A-6118-S	Hydraulic Oil Filter.....	H-5107
HX140B (FORKLIFTS)		Fuel Filter.....	F-1304	Oil Filter By Pass.....	0-1510
KUBOTA D1105-K , 2004		Hydraulic Oil Filter.....	H-2719	KH500-3 (CRANES)	
Fuel Filter.....	F-5202	Oil Filter Full Flow.....	0-1301	ISUZU 6RB1T	
Hydraulic Oil Filter.....	H-2712	KH180 (CRANES)		Air Filter Primary.....	A-6113
HX220B (FORKLIFTS)		HITACHI DH100		Air Filter Secondary.....	A-5408
ISUZU 48G1 , 2008		Fuel Filter.....	F-1303	Fuel Filter.....	FC-2703
Air Filter Secondary.....	A-2704	Oil Filter Full Flow.....	0-1506	Hydraulic Oil Filter.....	H-2719
Fuel Filter.....	FC-1801	KH230-3 (CRANES)		Oil Filter Full Flow.....	C-1312
Hydraulic Oil Filter.....	H-2703	HINO EM100 (S/N: 106-UP)		KH550 (CRANES)	
Hydraulic Oil Filter Suction.....	H-2706	Air Filter Primary.....	A-6006	ISUZU 6BD1	
Oil Filter Full Flow.....	C-2702	Air Filter Set.....	A-6118-S	Fuel Filter.....	FC-15031
HX99B (FORKLIFTS)		Fuel Filter.....	F-1304	KH70 (CRANES)	
KUBOTA D1105-BH , 2004		Hydraulic Oil Filter.....	H-2719	HINO D550A	
Fuel Filter.....	F-5202	Oil Filter Full Flow.....	0-1301	Air Filter.....	AS-1010
Hydraulic Oil Filter.....	H-2712	KH230-3 (CRANES)		Fuel Filter.....	F-1302
KH100 (CRANES)		HINO EM100 (S/N: 2450199-UP)		Oil Filter Full Flow.....	0-1301
HINO D550A		Air Filter Primary.....	A-6006	KH700 (CRANES)	
Air Filter.....	AS-1010	Air Filter Set.....	A-6118-S	ISUZU 12PB1 (S/N: 2530258-UP)	
KH100-2 (CRANES)		Fuel Filter.....	F-1304	Air Filter.....	AS-5707
HITACHI EL100		Hydraulic Oil Filter.....	H-2719	Fuel Filter.....	F-1503
Air Filter.....	AS-1010	Hydraulic Oil Filter.....	H-7911	Hydraulic Oil Filter.....	H-2719
Oil Filter Full Flow.....	0-1301	Oil Filter Full Flow.....	0-1301	Oil Filter By Pass.....	0-1510
KH125-2 (CRANES)		KH230-3 (CRANES)		KH700 (CRANES)	
HINO D550 (S/N: T0-400)		HINO EM100 (S/N: 2450200-UP)		ISUZU 8MA1	
Air Filter.....	AS-1010	Air Filter Primary.....	A-6006	Air Filter.....	AS-5707
Fuel Filter.....	F-1302	Air Filter Set.....	A-6118-S	Fuel Filter.....	F-1303
Oil Filter Full Flow.....	0-1301	Fuel Filter.....	F-1304	KH700-2 (CRANES)	
KH125-3 (CRANES)		Hydraulic Oil Filter.....	H-2719	ISUZU 12PB1	
HITACHI EM100		Hydraulic Oil Filter.....	H-7911	Air Filter.....	AS-5707
Air Filter Primary.....	A-6006	Oil Filter Full Flow.....	0-1301	Fuel Filter.....	F-1503
Air Filter Set.....	A-6118-S	KH300 (CRANES)		Oil Filter By Pass.....	0-1510
Fuel Filter.....	F-1304	HITACHI 8MA1		KH850-3 (CRANES)	
Hydraulic Oil Filter.....	H-2719	Air Filter.....	AS-5707	ISUZU 6RB1T	
Hydraulic Oil Filter.....	H-7911	Fuel Filter.....	F-1303	Air Filter Primary.....	A-6113
Oil Filter Full Flow.....	0-1301	KH300 (CRANES)		Air Filter Secondary.....	A-5408
KH150-2 (CRANES)		ISUZU (S/N: 2100088-UP)		Fuel Filter.....	FC-2703
NISSAN PD604		Air Filter.....	AS-5707	Hydraulic Oil Filter.....	H-2719
Fuel Filter.....	F-1803	Fuel Filter.....	F-1303	Oil Filter Full Flow.....	C-1312
KH300-2 (CRANES)		KH300-2 (CRANES)		LX145E (LOADERS)	
ISUZU 8MA1		ISUZU 8MA1		ISUZU BB 6BG1 TRF (S/N: T0-01499) , 2004	

MODEL/APPLICATION	SAKURA NO	MODEL/APPLICATION	SAKURA NO	MODEL/APPLICATION	SAKURA NO
HITACHI		HITACHI		HITACHI	
LX145E (LOADERS) ISUZU BB 6BG1 TRF (S/N: T0-01499) , 2004		Air Filter Primary.....	A-76670	LX450-7 (LOADERS) MITSUBISHI S6A3-Y2TAA1 (S/N: 101-UP) , 2006	
Air Filter Primary.....	AS-1024	Air Filter Secondary.....	A-76660	Fuel Filter.....	FC-1810
Air Filter Set.....	AS-1024-S	Air Filter Set.....	A-76670-S	LX450-7 (LOADERS) MITSUBISHI S6A3-Y2	
Fuel Filter.....	FC-1503	LX150-2 (LOADERS) w/JD 6081 Eng.		Fuel Filter.....	FC-58010
Oil Filter By Pass.....	C-1506	Air Filter Primary.....	A-76670	LX450-7 (LOADERS) MITSUBISHI S6A3-Y2TAA1	
Oil Filter Full Flow.....	C-5505	Air Filter Secondary.....	A-76660	Oil Filter By Pass.....	C-5201
LX145E (LOADERS) ISUZU 6BG1		Air Filter Set.....	A-76670-S	LX50-7 (LOADERS) KUBOTA V3300-DI-KA , 2006	
Fuel Filter.....	FC-15031	LX100 (LOADERS) ISUZU 6BD1T		Air Filter Primary.....	A-8505
LX145E (LOADERS) S/N: 01500-UP		Fuel Filter.....	FC-15031	Air Filter Secondary.....	A-8599
Air Filter Primary.....	AS-1024	LX100-1 (LOADERS) ISUZU 6BD1T		LX70 (LOADERS) ISUZU 4BD1	
Air Filter Set.....	AS-1024-S	Fuel Filter.....	FC-15031	Air Filter.....	A-2715
Fuel Filter.....	FC-1503	LX100-2 (LOADERS) ISUZU W06DT		Air Filter Primary.....	AS-7805
LX145E-2 (LOADERS) ISUZU BB 6BG1 TRF (S/N: 01500-UP) , 2006		Fuel Filter.....	FC-15031	Air Filter Secondary.....	A-7806
Air Filter Primary.....	AS-1024	LX100-2 (LOADERS) John Deere 6059		Air Filter Set.....	AS-5656-S
Air Filter Set.....	AS-1024-S	Fuel Filter.....	FC-15031	Hydraulic Oil Filter.....	H-2703
Fuel Filter.....	FC-1503	LX210 (LOADERS) ISUZU , 2004		LX70-2 (LOADERS) HINO W04CT	
Oil Filter Full Flow.....	C-5505	Air Filter Primary.....	A-2210	Fuel Filter.....	FC-15031
LX145E-2 (LOADERS) ISUZU 6BG1		Air Filter Secondary.....	A-6008	LX70-2C (LOADERS) HINO W04CT	
Fuel Filter.....	FC-15031	Fuel Filter.....	FC-2703	Fuel Filter.....	FC-15031
LX170 (LOADERS) ISUZU , 2004		LX210E (LOADERS) ISUZU 6HK1 TQF (S/N: T0-01499) , 2006		LX80 (LOADERS) ISUZU 6BD1	
Air Filter Primary.....	AS-1024	Air Filter Primary.....	A-2210	Fuel Filter.....	FC-15031
Air Filter Set.....	AS-1024-S	Air Filter Secondary.....	A-6008	LX80 (LOADERS) ISUZU 6BD1T	
Fuel/Water Separator.....	SFC-5705	Fuel Filter.....	FC-2703	Fuel Filter.....	FC-15031
Oil Filter By Pass.....	C-1506	LX290 (LOADERS) ISUZU , 2004		LX80 (LOADERS) HINO W04D-T	
LX170E (LOADERS) ISUZU BB 6BG1 TRF (S/N: T0-01499) , 2006		Air Filter Primary.....	AS-8579	Fuel Filter.....	FC-15031
Air Filter Primary.....	AS-1024	Air Filter Primary.....	AS-8579M	LX80-1 (LOADERS) ISUZU 6BD1	
Air Filter Set.....	AS-1024-S	Air Filter Secondary.....	A-8580	Fuel Filter.....	FC-15031
Fuel Filter.....	FC-1503	Air Filter Set.....	AS-8579-S	LX80-2 (LOADERS) HINO W04D-T	
Oil Filter By Pass.....	C-1506	Fuel Filter.....	FC-2703	Fuel Filter.....	FC-15031
Oil Filter Full Flow.....	C-5505	Oil Filter By Pass.....	C-1327	LX80-2C (LOADERS) HINO W04D-T	
LX170E (LOADERS) ISUZU 6BG1		Oil Filter Full Flow.....	C-5505	Fuel Filter.....	FC-15031
Fuel Filter.....	FC-15031	LX290E (LOADERS) ISUZU 6SD1 XQF (S/N: T0-01499) , 2006		LX80-2 (LOADERS) ISUZU W04D	
LX170E (LOADERS) S/N: 01500-UP		Air Filter Primary.....	AS-8579	Fuel Filter.....	FC-15031
Air Filter Primary.....	AS-1024	Air Filter Primary.....	AS-8579M	LX80-2 (LOADERS) ISUZU W04D	
Air Filter Set.....	AS-1024-S	Air Filter Secondary.....	A-8580	Fuel Filter.....	FC-15031
Fuel Filter.....	FC-1503	Air Filter Set.....	AS-8579-S	LX80-2C (LOADERS) HINO W04D-T	
LX170E-2 (LOADERS) ISUZU BB 6BG1 TRF , 2006		Fuel Filter.....	FC-2703	Fuel Filter.....	FC-15031
Air Filter Primary.....	AS-1024	Oil Filter By Pass.....	C-1327	LX80-2C (LOADERS) HINO W04D-T	
Air Filter Set.....	AS-1024-S	Oil Filter Full Flow.....	C-5505	Fuel Filter.....	FC-15031
Fuel Filter.....	FC-1503	LX300-7A (LOADERS) ISUZU 6WG1 XQC-01 (S/N: 01102-UP) , 2006		PD7 (PILE DRIVERS) HINO DS50A	
Oil Filter Full Flow.....	C-5505	Air Filter Secondary.....	A-7915	Air Filter.....	AS-1010
LX170E-2 (LOADERS) ISUZU 6BG1		Fuel Filter.....	FC-2703	Fuel Filter.....	F-1302
Fuel Filter.....	FC-15031	LX360E (LOADERS) ISUZU 6WG1 , 2006		Oil Filter Full Flow.....	O-1301
LX150-2 (LOADERS) w/JD 6076 Eng.		Air Filter Secondary.....	A-7915	PD9 (PILE DRIVERS) NISSAN PD604	
Fuel Filter.....	FC-15031	Fuel Filter.....	FC-2703		

MODEL/APPLICATION	SAKURA NO	MODEL/APPLICATION	SAKURA NO	MODEL/APPLICATION	SAKURA NO
HITACHI		HITACHI		HITACHI	
PD9 (PILE DRIVERS) NISSAN PD604		SCX900-2 (CRANES) MITSUBISHI 6D24T (S/N: 000101-UP) , 2004		Oil Filter Full Flow.....	C-8012
Hydraulic Oil Filter.....	H-7911	Air Filter Primary.....	A-1013	UE30 (EXCAVATORS) HITACHI MMC KAE	
Oil Filter By Pass.....	0-1804	Air Filter Primary.....	A-10134	Oil Filter Full Flow.....	C-5205
SCX550 (CRANES) ISUZU BB-6HK1-TQA		Air Filter Set.....	A-1841-S	UE50 (EXCAVATORS) ISUZU 4JC1	
Air Filter Primary.....	A-6006	Hydraulic Oil Filter.....	HC-5602	Air Filter Primary.....	AS-1014
Air Filter Set.....	A-6118-S	T012 (LOADERS) HITACHI B60B		Fuel Filter.....	FC-1501
Fuel Filter.....	FC-2703	Air Filter.....	A-5708	Oil Filter Full Flow.....	C-1511
Hydraulic Oil Filter.....	H-2719	Air Filter.....	AS-5708	Oil Filter Full Flow.....	C-1538
Hydraulic Oil Filter.....	HC-5602	Fuel Filter.....	F-2604	UE50 (EXCAVATORS) NISSAN	
Hydraulic Oil Filter Suction.....	H-2706	T09 (LOADERS) HITACHI B40B		Air Filter Primary.....	AS-1014
SCX550-3 (CRANES) ISUZU 4HK1		Air Filter.....	AS-1010	Fuel Filter.....	FC-1501
Air Filter Primary.....	A-5539	Fuel Filter.....	F-2604	Oil Filter Full Flow.....	C-1511
Air Filter Primary.....	A-5539M	T113 (LOADERS)		Oil Filter Full Flow.....	C-1538
Air Filter Secondary.....	A-5538	Fuel Filter.....	F-2604	Oil Filter Full Flow.....	C-1806
Air Filter Set.....	A-2709-S	TS015B (LOADERS) HITACHI K60		UH003 (EXCAVATORS) HITACHI Z600-K1	
Air Filter Set.....	A-2709M-S	Air Filter.....	A-5708	Fuel Filter.....	F-7909
Hydraulic Oil Filter.....	H-2719	Air Filter.....	AS-5708	UH004 (EXCAVATORS) HITACHI D850BH	
Hydraulic Oil Filter.....	H-2727	Fuel Filter.....	F-2604	Fuel Filter.....	FC-1206
Hydraulic Oil Filter.....	HC-5602	U106 (CRANES)		UH005 (EXCAVATORS) HITACHI D950BH	
Hydraulic Oil Filter Suction.....	H-2706	Air Filter.....	AS-1010	Air Filter Primary.....	AS-2205
SCX700 (CRANES) ISUZU BB-6HK1-TQA		Fuel Filter.....	F-2603	Fuel Filter.....	F-7909
Air Filter Primary.....	A-6006	Fuel Filter.....	F-2604	UH006 (EXCAVATORS) HITACHI D1302BH	
Air Filter Set.....	A-6118-S	UE004 (EXCAVATORS) HITACHI MMC K3B		Air Filter Primary.....	AS-2205
Fuel Filter.....	FC-2703	Air Filter.....	AS-5412	Fuel Filter.....	FC-1206
Hydraulic Oil Filter.....	H-2719	Oil Filter Full Flow.....	C-1011	UH02 (EXCAVATORS) ISUZU C330	
Hydraulic Oil Filter.....	HC-5602	UE005 (EXCAVATORS) HITACHI MMC K3E		Air Filter Primary.....	A-5628
Hydraulic Oil Filter Suction.....	H-2706	Oil Filter Full Flow.....	C-1011	Air Filter Primary.....	AS-1014
SCX2800-2 (CRANES) MITSUBISHI 6M70-TL (S/N: TIER 3-UP) , 2008		UE008 (EXCAVATORS) HITACHI MMC K4E		Air Filter Primary.....	AS-5628
Air Filter Primary.....	A-6010	Oil Filter Full Flow.....	C-5205	Air Filter Set.....	A-5628-S
Air Filter Secondary.....	A-6011	UE014 (EXCAVATORS) NISSAN		Oil Filter Full Flow.....	0-1503
Hydraulic Oil Filter.....	HC-5602	Air Filter Primary.....	AS-1014	UH025 (EXCAVATORS) ISUZU 4BBL	
SCX2800-2 (CRANES) w/Mitsubishi 6M70-TL Eng. (Tier 3)		Oil Filter Full Flow.....	C-1806	Air Filter Primary.....	AS-1014
Air Filter Set.....	A-13092-S	UE10 (EXCAVATORS) HITACHI MMC K3B		Oil Filter Full Flow.....	0-1503
SCX400 (CRANES) ISUZU 6HK1		Air Filter.....	AS-5412	UH025-7 (EXCAVATORS) ISUZU FD3304	
Hydraulic Oil Filter.....	H-2727	Oil Filter Full Flow.....	C-1011	Air Filter Primary.....	AS-1014
SCX400 (CRANES) ISUZU BB-6HK1-TQA		Oil Filter Full Flow.....	C-8012	Oil Filter Full Flow.....	C-6101
Air Filter Primary.....	A-6006	UE15 (EXCAVATORS) ISUZU 3KB1		UH025-7 (EXCAVATORS) NISSAN FD3304	
Air Filter Set.....	A-6118-S	Air Filter.....	AS-5412	Fuel Filter.....	FC-1824
Fuel Filter.....	FC-2703	UE20 (EXCAVATORS) HITACHI MMC K3E		UH03 (EXCAVATORS) ISUZU DA220	
Hydraulic Oil Filter.....	H-2719	Air Filter.....	AS-5412	Air Filter Primary.....	AS-1014
Hydraulic Oil Filter.....	HC-5602	Oil Filter Full Flow.....	C-1011	Fuel Filter.....	F-1303
Hydraulic Oil Filter Suction.....	H-2706	Oil Filter Full Flow.....	C-5205	Oil Filter Full Flow.....	0-1505
SCX900 (CRANES) MITSUBISHI 6D24T		UH03 (EXCAVATORS) ISUZU 4BB1			
Air Filter Primary.....	A-6113				
Air Filter Secondary.....	A-5408				
Hydraulic Oil Filter.....	H-2719				
Hydraulic Oil Filter.....	HC-5602				

Sakura Filter

ENGINE APPLICATION

MODEL/APPLICATION	SAKURA NO	MODEL/APPLICATION	SAKURA NO	MODEL/APPLICATION	SAKURA NO
HITACHI		HITACHI		HITACHI	
UH03 (EXCAVATORS) ISUZU 48B1		UH045-1 (EXCAVATORS) ISUZU 6BD1		UH06 (EXCAVATORS) DAF	
Hydraulic Oil Filter.....	H-7912	Air Filter Primary.....	A-5628	Air Filter Primary.....	A-5628
UH03-1 (EXCAVATORS) ISUZU 48B1		Air Filter Primary.....	AS-5628	Air Filter Primary.....	AS-5628
Air Filter Primary.....	AS-1014	Air Filter Set.....	A-5628-S	Air Filter Set.....	A-5628-S
Oil Filter Full Flow.....	O-1503	Fuel Filter.....	F-1303	Hydraulic Oil Filter.....	H-7912
UH03-3 (EXCAVATORS) HITACHI FD3304 (S/N: 5501-UP)		UH045-7 (EXCAVATORS) HITACHI 6BBL		UH06 (EXCAVATORS) ISUZU DA640	
Air Filter Primary.....	AS-1014	Fuel Filter.....	F-1303	Air Filter Primary.....	A-5628
UH03-3 (EXCAVATORS) ISUZU 48B1		Oil Filter Full Flow.....	O-1301	Air Filter Primary.....	AS-5628
Air Filter Primary.....	AS-1014	UH045-7 (EXCAVATORS) ISUZU 6BB1		Air Filter Set.....	A-5628-S
Fuel Filter.....	FC-1824	Fuel Filter.....	FC-15031	Fuel Filter.....	F-1303
Oil Filter Full Flow.....	O-1503	UH045-7 (EXCAVATORS) ISUZU 6BD1		Hydraulic Oil Filter.....	H-2702
UH03-3 (EXCAVATORS) NISSAN FD3304		Fuel Filter.....	FC-15031	Hydraulic Oil Filter.....	H-7912
Fuel Filter.....	FC-1824	UH04-7 (EXCAVATORS) ISUZU 4BBL		Oil Filter Full Flow.....	O-1506
UH0357 (EXCAVATORS) HITACHI 4BBL		Air Filter Primary.....	A-2703	UH061 (EXCAVATORS) ISUZU 6BD1	
Oil Filter Full Flow.....	C-2702	Air Filter Set.....	A-2703-S	Air Filter Primary.....	A-5628
UH03M-2 (EXCAVATORS) HINO EC100A		Hydraulic Oil Filter.....	H-2704	Air Filter Primary.....	AS-5628
Air Filter Primary.....	A-5628	Oil Filter Full Flow.....	O-1503	Air Filter Set.....	A-5628-S
Air Filter Primary.....	AS-5628	UH05 (EXCAVATORS) ISUZU 6BBL		Fuel Filter.....	F-1303
Air Filter Set.....	A-5628-S	Fuel Filter.....	F-1303	Hydraulic Oil Filter.....	H-2704
Fuel Filter.....	F-1303	UH051 (EXCAVATORS) ISUZU 6BB1		Oil Filter Full Flow.....	O-1301
Oil Filter Full Flow.....	O-1301	Air Filter Primary.....	A-5628	Oil Filter Full Flow.....	O-1503
UH04 (EXCAVATORS) HINO EC100		Air Filter Primary.....	AS-5628	UH063 (EXCAVATORS) ISUZU 6BB1	
Air Filter Primary.....	A-5628	Air Filter Set.....	A-5628-S	Fuel Filter.....	FC-15031
Air Filter Primary.....	AS-5628	Fuel Filter.....	F-1303	UH063 (EXCAVATORS) ISUZU 6BD1	
Air Filter Set.....	A-5628-S	Hydraulic Oil Filter.....	H-2704	Fuel Filter.....	F-1303
Fuel Filter.....	F-1303	Oil Filter Full Flow.....	O-1503	Fuel Filter.....	FC-1503
Oil Filter Full Flow.....	O-1301	UH051D (EXCAVATORS)		Hydraulic Oil Filter.....	H-2714
UH04 (EXCAVATORS) ISUZU 6BBL		Air Filter Primary.....	A-5628	Oil Filter Full Flow.....	O-1301
Air Filter Primary.....	A-5628	Air Filter Primary.....	AS-5628	UH06-5 (EXCAVATORS) ISUZU 6BD1	
Air Filter Primary.....	AS-5628	Air Filter Set.....	A-5628-S	Air Filter Primary.....	A-5628
Air Filter Set.....	A-5628-S	Fuel Filter.....	F-1303	Air Filter Primary.....	AS-5628
Fuel Filter.....	F-1303	Hydraulic Oil Filter.....	H-2704	Air Filter Set.....	A-5628-S
Oil Filter Full Flow.....	O-1301	Oil Filter Full Flow.....	O-1503	Fuel Filter.....	F-1303
Oil Filter Full Flow.....	O-1503	UH052 (EXCAVATORS) ISUZU 6BB1		Hydraulic Oil Filter.....	H-2702
UH041 (EXCAVATORS) ISUZU 48B1		Air Filter Primary.....	A-5628	UH066DT (EXCAVATORS) PERKINS 6.354	
Air Filter Primary.....	AS-1014	Air Filter Primary.....	AS-5628	Fuel Filter.....	FC-5103
Hydraulic Oil Filter.....	H-7912	Air Filter Set.....	A-5628-S	Oil Filter Full Flow.....	C-5102
Oil Filter Full Flow.....	O-1503	Fuel Filter.....	F-1303	UH07 (EXCAVATORS) ISUZU DA640	
UH043 (EXCAVATORS) ISUZU 48B1		Hydraulic Oil Filter.....	H-2704	Hydraulic Oil Filter.....	H-2702
Air Filter Primary.....	AS-1014	Oil Filter Full Flow.....	O-1503	Hydraulic Oil Filter.....	H-7912
Fuel Filter.....	FC-2702	UH053 (EXCAVATORS) ISUZU 4BD1		UH071 (EXCAVATORS) ISUZU 6BD1	
Hydraulic Oil Filter.....	H-2705	Fuel Filter.....	F-1303	Hydraulic Oil Filter.....	H-7912
Hydraulic Oil Filter.....	H-2714	Fuel Filter.....	FC-2702	UH073 (EXCAVATORS) HINO DS50	
Oil Filter Full Flow.....	C-2702	Hydraulic Oil Filter.....	H-2714	Hydraulic Oil Filter.....	H-2702
Oil Filter Full Flow.....	O-1503	Oil Filter Full Flow.....	C-2702		
		Oil Filter Full Flow.....	O-1503		

MODEL/APPLICATION	SAKURA NO	MODEL/APPLICATION	SAKURA NO	MODEL/APPLICATION	SAKURA NO
HITACHI		HITACHI		HITACHI	
UH073 (EXCAVATORS) ISUZU 68B1		Fuel Filter.....	FC-1503	Hydraulic Oil Filter.....	H-2705
Fuel Filter.....	F-1303	Fuel Filter.....	FC-15031	UH031 (EXCAVATORS) ISUZU 48B1	
Fuel Filter.....	FC-1503	Hydraulic Oil Filter.....	H-2704	Hydraulic Oil Filter.....	H-7912
Fuel Filter.....	FC-15031	Hydraulic Oil Filter.....	H-2714	UH10 (EXCAVATORS) ISUZU 120	
Oil Filter Full Flow.....	O-1301	Oil Filter By Pass.....	O-2701	Air Filter Primary.....	A-2210
UH07-5 (EXCAVATORS) HINO EL100		Oil Filter Full Flow.....	O-1301	Fuel Filter.....	F-1303
Air Filter.....	AS-1010	UH083 (EXCAVATORS) ISUZU 6DD1		Hydraulic Oil Filter.....	H-2704
Hydraulic Oil Filter.....	H-2702	Fuel Filter.....	FC-15031	Oil Filter Full Flow.....	O-1506
Hydraulic Oil Filter.....	H-2704	UH083LC (EXCAVATORS) ISUZU 6BD1T		UH10 (EXCAVATORS) ISUZU E120	
Oil Filter Full Flow.....	O-1301	Fuel Filter.....	FC-15031	Hydraulic Oil Filter.....	H-2702
UH07-7 (EXCAVATORS) ISUZU 6BD1T		UH083LC (EXCAVATORS) ISUZU 6BDTIT		UH101 (EXCAVATORS) HINO EL100	
Air Filter Primary.....	A-5627	Air Filter Primary.....	A-5627	Air Filter.....	AS-1010
Air Filter Set.....	A-5663-S	Air Filter Set.....	A-5663-S	Hydraulic Oil Filter.....	H-2702
Fuel Filter.....	FC-1503	Fuel Filter.....	FC-1503	Hydraulic Oil Filter.....	H-7912
Fuel Filter.....	FC-15031	UH09 (EXCAVATORS) HINO DS50		Oil Filter Full Flow.....	O-1301
Hydraulic Oil Filter.....	H-2702	Air Filter.....	AS-1010	UH103 (EXCAVATORS) HINO EM100	
Hydraulic Oil Filter.....	H-2704	Air Filter Primary.....	A-5628	Air Filter Primary.....	A-6006
UH07LC (EXCAVATORS) HINO EL100		Air Filter Primary.....	AS-5628	Air Filter Secondary.....	A-6007
Hydraulic Oil Filter.....	H-2702	Air Filter Set.....	A-5628-S	Air Filter Set.....	A-6118-S
UH07LC-5 (EXCAVATORS) HINO EL100		Fuel Filter.....	F-1302	Fuel Filter.....	F-1304
Air Filter Primary.....	A-5627	Hydraulic Oil Filter.....	H-2702	Hydraulic Oil Filter.....	H-2704
Air Filter Set.....	A-5663-S	Oil Filter By Pass.....	O-2701	Oil Filter Full Flow.....	O-1301
Fuel Filter.....	F-1302	Oil Filter Full Flow.....	O-1301	UH10-7 (EXCAVATORS) HINO EM100	
Hydraulic Oil Filter.....	H-2702	UH09-2 (EXCAVATORS) HINO EL100		Hydraulic Oil Filter.....	H-2702
Oil Filter Full Flow.....	O-1301	Air Filter.....	AS-1010	UH12 (EXCAVATORS) HITACHI B60	
UH07S (EXCAVATORS) HINO EL100		Fuel Filter.....	F-1302	Air Filter Primary.....	A-2210
Hydraulic Oil Filter.....	H-2702	Hydraulic Oil Filter.....	H-2702	Hydraulic Oil Filter.....	H-2702
UH07S-5 (EXCAVATORS) HINO EL100		Hydraulic Oil Filter.....	H-2704	UH12 (EXCAVATORS) HITACHI K60	
Hydraulic Oil Filter.....	H-2702	Oil Filter Full Flow.....	O-1301	Air Filter Primary.....	A-2210
UH08 (EXCAVATORS) HINO EL100		UH09-7 (EXCAVATORS) HINO EM100		Hydraulic Oil Filter.....	H-2702
Fuel Filter.....	F-1302	Air Filter Primary.....	A-6006	UH12 (EXCAVATORS) ISUZU E120	
Oil Filter Full Flow.....	O-1301	Air Filter Set.....	A-6118-S	Fuel Filter.....	F-1504
UH081 (EXCAVATORS) HINO EL100		Hydraulic Oil Filter.....	H-2702	Oil Filter Full Flow.....	O-1506
Air Filter.....	AS-1010	Hydraulic Oil Filter.....	H-2704	UH12 (EXCAVATORS) ISUZU EP100	
Hydraulic Oil Filter.....	H-2702	Oil Filter Full Flow.....	O-1301	Air Filter Primary.....	A-6006
Hydraulic Oil Filter.....	H-2704	UH07-3 (EXCAVATORS) HINO DS50A		Air Filter Set.....	A-6118-S
Oil Filter Full Flow.....	O-1301	Air Filter Primary.....	A-5628	Fuel Filter.....	F-1304
UH082 (EXCAVATORS)		Air Filter Primary.....	AS-5628	Hydraulic Oil Filter.....	H-2704
Air Filter.....	AS-1010	Air Filter Set.....	A-5628-S	UH121 (EXCAVATORS) ISUZU E120	
Oil Filter Full Flow.....	O-1301	Fuel Filter.....	F-1302	Air Filter Primary.....	A-2210
UH083 (EXCAVATORS) ISUZU 6BD1		Oil Filter Full Flow.....	O-1301	Fuel Filter.....	F-1504
Air Filter Primary.....	A-5627	UH033 (EXCAVATORS) ISUZU 48B1		Hydraulic Oil Filter.....	H-2702
Air Filter Secondary.....	A-6008	Hydraulic Oil Filter.....	H-7912	Hydraulic Oil Filter.....	H-7912
Air Filter Set.....	A-5663-S	UH033 (EXCAVATORS)		Oil Filter Full Flow.....	O-1506
Fuel Filter.....	F-1303	NISSAN FD3304		UH122 (EXCAVATORS)	

Sakura Filter

ENGINE APPLICATION

MODEL/APPLICATION	SAKURA NO	MODEL/APPLICATION	SAKURA NO	MODEL/APPLICATION	SAKURA NO
HITACHI		HITACHI		HITACHI	
UH122 (EXCAVATORS)		Air Filter Primary.....	A-6113	UH53 (EXCAVATORS) HITACHI 4BD1	
Air Filter Primary.....	A-2210	Air Filter Secondary.....	A-5408	Fuel Filter.....	F-1303
Fuel Filter.....	F-1504	Fuel Filter.....	F-1504	Fuel Filter.....	FC-2702
Oil Filter Full Flow.....	O-1506	Hydraulic Oil Filter.....	H-2702	Hydraulic Oil Filter.....	H-2714
		Hydraulic Oil Filter.....	H-2704	Oil Filter Full Flow.....	C-2702
UH123 (EXCAVATORS) HINO EM100		Oil Filter Full Flow.....	C-1312		
Air Filter Primary.....	A-6006	Oil Filter Full Flow.....	O-1506	UH52 (EXCAVATORS) ISUZU 6BBL , 1975	
Air Filter Secondary.....	A-6007			Fuel Filter.....	F-1303
Air Filter Set.....	A-6118-S	UH172 (EXCAVATORS)		Oil Filter Full Flow.....	O-1301
Hydraulic Oil Filter.....	H-2704	Hydraulic Oil Filter.....	H-2704		
Hydraulic Oil Filter.....	H-2714	UH122LC (EXCAVATORS) ISUZU E120		UH62 (EXCAVATORS) ISUZU 6BD1	
		Hydraulic Oil Filter.....	H-7912	Fuel Filter.....	F-1303
UH14 (EXCAVATORS) DETROIT 6-71				Oil Filter Full Flow.....	O-1301
Air Filter Primary.....	A-2210	UH20 (EXCAVATORS) ISUZU E120			
Fuel Filter Primary.....	FC-6501	Hydraulic Oil Filter.....	H-2702	UH80 (EXCAVATORS) CUMMINS KT-1150 (QTY 2)	
Fuel Filter Secondary.....	FC-6502			Coolant Filter.....	WC-5705
Oil Filter Full Flow.....	O-6503	UH20 (EXCAVATORS) ISUZU E120(2)		Fuel Filter.....	FC-5702
		Air Filter Primary.....	A-2210	Oil Filter By Pass.....	C-5718
UH14 (EXCAVATORS) ISUZU E120		Fuel Filter.....	F-1504	Oil Filter By Pass.....	O-5704
Air Filter.....	AS-5707	Hydraulic Oil Filter.....	H-2704	Oil Filter Full Flow.....	C-5715
Air Filter Primary.....	A-2210	Oil Filter Full Flow.....	O-1506		
Fuel Filter.....	F-1303	UH23 (EXCAVATORS) ISUZU 6RB1		UH801 (EXCAVATORS) CUMMINS KT-1150 (QTY 2)	
Fuel Filter.....	F-1504	Hydraulic Oil Filter.....	H-2702	Air Filter Primary.....	A-6113
Hydraulic Oil Filter.....	H-2702			Air Filter Secondary.....	A-5408
Hydraulic Oil Filter.....	H-2704	UH23 (EXCAVATORS) ISUZU E120 (QTY 2)		Coolant Filter.....	WC-5705
Oil Filter Full Flow.....	O-1506	Air Filter.....	AS-5707	Fuel Filter.....	FC-5702
		Air Filter Primary.....	A-2210	Hydraulic Oil Filter.....	H-2704
UH143 (EXCAVATORS) HITACHI EP100		Fuel Filter.....	F-1504	Oil Filter By Pass.....	C-5718
Air Filter Primary.....	A-1313	Hydraulic Oil Filter.....	H-2704	Oil Filter By Pass.....	O-5704
Air Filter Secondary.....	A-1307	Oil Filter Full Flow.....	O-1506	Oil Filter Full Flow.....	C-5715
Air Filter Set.....	A-5662-S	UH261 (EXCAVATORS) ISUZU E120			
Fuel Filter.....	F-1304	Air Filter Primary.....	A-2210	UH81 (EXCAVATORS) HINO EL100	
Hydraulic Oil Filter.....	H-2704	Air Filter Secondary.....	A-6008	Hydraulic Oil Filter.....	H-2704
Oil Filter By Pass.....	C-5718	Fuel Filter.....	F-1504	Oil Filter Full Flow.....	O-1301
		Hydraulic Oil Filter.....	H-2704		
UH143LC (EXCAVATORS) HINO		Oil Filter Full Flow.....	O-1506	UHM14 (EXCAVATORS) HITACHI D1301BH	
Air Filter Primary.....	A-1313			Air Filter Primary.....	AS-2205
Air Filter Secondary.....	A-1307	UH30 (EXCAVATORS) ISUZU E120		Fuel Filter.....	FC-1206
Air Filter Set.....	A-5662-S	Hydraulic Oil Filter.....	H-2702		
Fuel Filter.....	FC-5720			WH03 (EXCAVATORS) ISUZU DA220	
Oil Filter By Pass.....	C-5718	UH30 (EXCAVATORS)		Air Filter Primary.....	AS-1014
		Air Filter.....	AS-5707	Fuel Filter.....	F-1303
UH17 (EXCAVATORS) ISUZU E120		Fuel Filter.....	F-1504	Oil Filter Full Flow.....	O-1505
Fuel Filter.....	F-1504	Hydraulic Oil Filter.....	H-2704		
Oil Filter Full Flow.....	O-1506	Oil Filter Full Flow.....	O-1506	WH04 (EXCAVATORS) ISUZU 6BB1	
				Air Filter Primary.....	A-5628
UH171 (EXCAVATORS) ISUZU E120		UH30 (EXCAVATORS)		Air Filter Primary.....	AS-1014
Air Filter.....	AS-5707	Air Filter.....	AS-5707	Air Filter Primary.....	AS-5628
Fuel Filter.....	F-1303	Fuel Filter.....	F-1504	Air Filter Set.....	A-5628-S
Fuel Filter.....	F-1504	Hydraulic Oil Filter.....	H-2704	Fuel Filter.....	F-1303
Hydraulic Oil Filter.....	H-2702	Oil Filter Full Flow.....	O-1506	Oil Filter Full Flow.....	O-1503
Hydraulic Oil Filter.....	H-2704				
Oil Filter By Pass.....	C-5718	UH43 (EXCAVATORS) HITACHI 4BB1		WH04 (EXCAVATORS) ISUZU 6BBL	
Oil Filter Full Flow.....	O-1506	Air Filter Primary.....	AS-1014	Air Filter Primary.....	A-5628
		Fuel Filter.....	FC-2702	Air Filter Primary.....	AS-5628
UH181 (EXCAVATORS) ISUZU 6RB1		Hydraulic Oil Filter.....	H-2714	Air Filter Set.....	A-5628-S
		Oil Filter Full Flow.....	C-2702		

Sakura Filter

ENGINE APPLICATION

MODEL/APPLICATION	SAKURA NO	MODEL/APPLICATION	SAKURA NO	MODEL/APPLICATION	SAKURA NO
HITACHI		HITACHI		HITACHI	
WH04 (EXCAVATORS) ISUZU 688L		ZW220 (LOADERS) ISUZU 6W61		ZX110-E (EXCAVATORS) ISUZU 48G1	
Fuel Filter.....	F-1303	Hydraulic Oil Filter.....	H-27360	Fuel Filter.....	FC-1824
Oil Filter Full Flow.....	O-1503				
WH051 (EXCAVATORS) ISUZU 688L		ZW250 (LOADERS) ISUZU (S/N: 00101-UP) , 2006		ZX110-E (EXCAVATORS) ISUZU 48G1T	
Fuel Filter.....	F-1303	Air Filter Primary.....	AS-5102	Cabin Air Filter.....	CA-27040
Oil Filter Full Flow.....	O-1301	Air Filter Secondary.....	A-8651	Cabin Air Filter.....	CA-27050
		Air Filter Set.....	AS-5102-S	Oil Filter Combination.....	C-2704
		Hydraulic Oil Filter Transmission..	HC-76130		
WH051D (EXCAVATORS) ISUZU 6881		ZW250 (LOADERS) ISUZU AH-6HK1X		ZX110M (EXCAVATORS) ISUZU 48G1	
Air Filter Primary.....	A-5628	Cabin Air Filter.....	CA-55090	Fuel Filter.....	FC-1824
Air Filter Primary.....	AS-5628				
Air Filter Set.....	A-5628-S	ZW250 (LOADERS) ISUZU 6HK1		ZX110M (EXCAVATORS) ISUZU 48G1T	
Fuel Filter.....	F-1303	Hydraulic Oil Filter.....	H-27360	Cabin Air Filter.....	CA-27040
Hydraulic Oil Filter.....	H-2704			Cabin Air Filter.....	CA-27050
Oil Filter Full Flow.....	O-1301			Fuel Filter.....	FC-1824
		ZW250 (LOADERS) ISUZU 6W61		Oil Filter Combination.....	C-2704
WH052 (EXCAVATORS) ISUZU 6881		Hydraulic Oil Filter.....	H-27360		
Air Filter Primary.....	A-5628	ZW310 (LOADERS) DAIMLERB OM460LA (S/N: 00101-UP) , 2006		ZX120 (EXCAVATORS) ISUZU 48G1T	
Air Filter Primary.....	AS-5628	Air Filter Primary.....	A-5614	Air Filter Primary.....	A-5541
Air Filter Set.....	A-5628-S	Air Filter Secondary.....	A-5610	Air Filter Primary.....	A-5541M
Fuel Filter.....	F-1303	Fuel/Water Separator.....	SFC-5301-10	Air Filter Secondary.....	A-5540
Hydraulic Oil Filter.....	H-2704	Fuel/Water Separator.....	SFC-5301-10B	Air Filter Secondary.....	A-7956
Oil Filter Full Flow.....	O-1503			Air Filter Set.....	A-5541M-S
		ZW310 (LOADERS) MERCEDES-BENZ OM 460 LA		Cabin Air Filter.....	CA-27040
WH073D (EXCAVATORS) ISUZU 68D1		Hydraulic Oil Filter.....	H-27360	Cabin Air Filter.....	CA-27050
Fuel Filter.....	F-1303			Fuel Filter.....	FC-1005
Hydraulic Oil Filter.....	H-2704	ZX110-3 (EXCAVATORS) ISUZU 4J-4JJ1X , 2008		Hydraulic Oil Filter.....	H-2703
Oil Filter Full Flow.....	O-1301	Cabin Air Filter.....	CA-27020	Oil Filter Combination.....	C-2704
		Cabin Air Filter.....	CA-27021		
WH801 (EXCAVATORS) CUMMINS KTA1150		ZX110-3 (EXCAVATORS) ISUZU AJ-4JJ1X		ZX120-3 (EXCAVATORS) ISUZU 4JJ1X	
Air Filter Secondary.....	A-5408	Cabin Air Filter.....	CA-27030	Cabin Air Filter.....	CA-27030
Coolant Filter.....	WC-5713	Cabin Air Filter.....	CA-27040		
Fuel Filter.....	FC-5720	Oil Filter Combination.....	C-2704	ZX120-E (EXCAVATORS) ISUZU 48G1T	
Oil Filter By Pass.....	O-5704			Cabin Air Filter.....	CA-27040
Oil Filter Full Flow.....	C-5715	ZX110 (EXCAVATORS) ISUZU 48G1 TRG		Cabin Air Filter.....	CA-27050
		Air Filter Primary.....	A-5541	Oil Filter Combination.....	C-2704
ZW140 (LOADERS) CUMMINS QSB4.5		Air Filter Primary.....	A-5541M		
Hydraulic Oil Filter.....	H-27400	Air Filter Primary.....	A-76231	ZX125 (EXCAVATORS) S/N: 10572-UP	
		Air Filter Secondary.....	A-5540	Air Filter Primary.....	A-5541
		Air Filter Set.....	A-7956	Air Filter Primary.....	A-5541M
ZW180 (LOADERS) CUMMINS QSB6.7 , 2007		Air Filter Set.....	A-5541M-S	Air Filter Primary.....	A-76231
Air Filter Secondary.....	A-8651	Fuel Filter.....	FC-1005	Air Filter Secondary.....	A-5540
Fuel/Water Separator.....	SFC-5711	Fuel Filter.....	FC-1801	Air Filter Set.....	A-5541M-S
Oil Filter Full Flow.....	C-5708	Hydraulic Oil Filter.....	H-2703	Fuel Filter.....	FC-1005
				Fuel Filter.....	FC-1801
ZW220 - 00101 (LOADERS) ISUZU ISUZU , 2006		ZX110 (EXCAVATORS) ISUZU BB-48G1T		Hydraulic Oil Filter.....	H-2703
Air Filter Primary.....	AS-5102	Cabin Air Filter.....	CA-27040		
Air Filter Set.....	AS-5102-S			ZX125 (EXCAVATORS) S/N: 10571	
		ZX110 (EXCAVATORS) w/Isuzu BB-48G1T Eng.		Air Filter Secondary.....	A-7956
ZW250 - 00101 (LOADERS) ISUZU ISUZU , 2006		Cabin Air Filter.....	CA-27050	Hydraulic Oil Filter.....	H-2703
Air Filter Primary.....	AS-5102	Oil Filter Combination.....	C-2704		
Air Filter Set.....	AS-5102-S			ZX125US-E (EXCAVATORS) ISUZU 48G1T	
				Cabin Air Filter.....	CA-27040
ZW220 (LOADERS) ISUZU 6HK1				Oil Filter Combination.....	C-2704
Hydraulic Oil Filter.....	H-27360				

MODEL/APPLICATION	SAKURA NO
HITACHI	
ZX125US-E (EXCAVATORS) ISUZU 4BG1T (S/N: 001001-UP)	
Air Filter Primary.....	A-5541
Air Filter Primary.....	A-5541M
Air Filter Primary.....	A-76231
Air Filter Secondary.....	A-5540
Air Filter Secondary.....	A-7956
Air Filter Set.....	A-5541M-S
Fuel Filter.....	FC-1005
Hydraulic Oil Filter.....	H-2703
ZX130 (EXCAVATORS) ISUZU CC-4BG1TC	
Cabin Air Filter.....	CA-27040
ZX130 (EXCAVATORS) S/N: 60138-UP	
Air Filter Primary.....	A-5541
Air Filter Primary.....	A-5541M
Air Filter Primary.....	A-76231
Air Filter Secondary.....	A-5540
Air Filter Set.....	A-5541M-S
Fuel Filter.....	FC-1005
Fuel Filter.....	FC-1801
Hydraulic Oil Filter.....	H-2703
ZX130 (EXCAVATORS) S/N: TO-60137	
Air Filter Primary.....	A-2708
Air Filter Secondary.....	A-7956
Air Filter Set.....	A-2711-S
Fuel Filter.....	FC-1005
Fuel Filter.....	FC-1801
Hydraulic Oil Filter.....	H-2703
ZX130 (EXCAVATORS) W/ISUZU CC-4BG1TC ENG.	
Cabin Air Filter.....	CA-27050
Oil Filter Combination.....	C-2704
ZX130H (EXCAVATORS) ISUZU 4BG1T	
Cabin Air Filter.....	CA-27040
Cabin Air Filter.....	CA-27050
Oil Filter Combination.....	C-2704
ZX130K (EXCAVATORS) ISUZU 4BG1T	
Cabin Air Filter.....	CA-27050
Oil Filter Combination.....	C-2704
ZX130LCN-3 (EXCAVATORS) ISUZU AJ-4JJ1X	
Cabin Air Filter.....	CA-27030
Cabin Air Filter.....	CA-27040
Oil Filter Combination.....	C-2704
ZX130W (EXCAVATORS) ISUZU 4BG1T	
Air Filter Primary.....	A-5539
Air Filter Primary.....	A-5539M
Air Filter Secondary.....	A-5538
Air Filter Set.....	A-2709-S
Air Filter Set.....	A-2709M-S
Cabin Air Filter.....	CA-27040

MODEL/APPLICATION	SAKURA NO
HITACHI	
Cabin Air Filter.....	CA-27050
Fuel Filter.....	FC-1005
Fuel Filter.....	FC-1801
Oil Filter Combination.....	C-2704
ZX135US (EXCAVATORS) ISUZU 4BG1T	
Cabin Air Filter.....	CA-27040
Oil Filter Combination.....	C-2704
ZX135US (EXCAVATORS) ISUZU 4BG1 TCG (S/N: 060001-UP)	
Air Filter Primary.....	A-5541
Air Filter Primary.....	A-5541M
Air Filter Primary.....	A-76231
Air Filter Secondary.....	A-5540
Air Filter Secondary.....	A-7956
Air Filter Set.....	A-5541M-S
Fuel Filter.....	FC-1005
Hydraulic Oil Filter.....	H-2703
ZX135US (EXCAVATORS) S/N: 62997-UP	
Air Filter Primary.....	A-5541
Air Filter Primary.....	A-5541M
Air Filter Primary.....	A-76231
Air Filter Secondary.....	A-5540
Air Filter Set.....	A-5541M-S
Fuel Filter.....	FC-1005
Fuel Filter.....	FC-1801
Hydraulic Oil Filter.....	H-2703
ZX135US (EXCAVATORS) S/N: TO-62996	
Air Filter Secondary.....	A-7956
Fuel Filter.....	FC-1005
Fuel Filter.....	FC-1801
Hydraulic Oil Filter.....	H-2703
ZX16 (EXCAVATORS) ISUZU 3VB1	
Fuel Filter.....	F-5207
Hydraulic Oil Filter.....	H-2712
Hydraulic Oil Filter.....	HC-5807
ZX18 (EXCAVATORS) ISUZU 3VB1	
Fuel Filter.....	F-5207
Hydraulic Oil Filter.....	H-2712
Hydraulic Oil Filter.....	HC-5807
ZX180 (EXCAVATORS)	
Air Filter Primary.....	A-5541
Air Filter Primary.....	A-5541M
Air Filter Primary.....	A-76231
Air Filter Secondary.....	A-5540
Air Filter Set.....	A-5541M-S
Fuel Filter.....	FC-1005
Fuel Filter.....	FC-1801
Hydraulic Oil Filter.....	H-2703
ZX180LC (EXCAVATORS) ISUZU 4BG1T	
Cabin Air Filter.....	CA-27040

MODEL/APPLICATION	SAKURA NO
HITACHI	
ZX180LC (EXCAVATORS) ISUZU AA-4BG1TCS (S/N: 005001-UP)	
Air Filter Primary.....	A-5541
Air Filter Primary.....	A-5541M
Air Filter Primary.....	A-76231
Air Filter Secondary.....	A-5540
Air Filter Set.....	A-5541M-S
Fuel Filter.....	FC-1005
Hydraulic Oil Filter.....	H-2703
ZX180LC-3 (EXCAVATORS) ISUZU AI-4JJ1X	
Cabin Air Filter.....	CA-27030
ZX180LCN (EXCAVATORS) ISUZU 4BG1T	
Cabin Air Filter.....	CA-27040
ZX180W (EXCAVATORS) ISUZU 4BG1X	
Cabin Air Filter.....	CA-27040
Cabin Air Filter.....	CA-27050
Hydraulic Oil Filter Return.....	H-27380
ZX180W (EXCAVATORS) ISUZU AA-4BG1 (S/N: 001001-UP)	
Air Filter Primary.....	A-5539
Air Filter Primary.....	A-5539M
Air Filter Secondary.....	A-5538
Air Filter Set.....	A-2709-S
Air Filter Set.....	A-2709M-S
Fuel Filter.....	FC-1005
Hydraulic Oil Filter Return.....	H-7981
Hydraulic Oil Filter Suction.....	H-2706
ZX180W (EXCAVATORS)	
Air Filter Primary.....	A-5539
Air Filter Primary.....	A-5539M
Air Filter Secondary.....	A-5538
Air Filter Set.....	A-2709-S
Air Filter Set.....	A-2709M-S
Fuel Filter.....	FC-1005
Fuel Filter.....	FC-1801
Hydraulic Oil Filter Return.....	H-7981
Hydraulic Oil Filter Suction.....	H-2706
ZX135USK (EXCAVATORS) ISUZU 4BG1T	
Cabin Air Filter.....	CA-27040
Oil Filter Combination.....	C-2704
ZX135USK (EXCAVATORS) ISUZU 4BG1 TCG (S/N: 060001-UP)	
Air Filter Primary.....	A-5541
Air Filter Primary.....	A-5541M
Air Filter Primary.....	A-76231
Air Filter Secondary.....	A-5540
Air Filter Secondary.....	A-7956
Air Filter Set.....	A-5541M-S
Fuel Filter.....	FC-1005
Hydraulic Oil Filter.....	H-2703
ZX160 (EXCAVATORS) ISUZU AA-4BG1TC	

MODEL/APPLICATION	SAKURA NO	MODEL/APPLICATION	SAKURA NO	MODEL/APPLICATION	SAKURA NO
HITACHI		HITACHI		HITACHI	
ZX160 (EXCAVATORS) ISUZU AA-4BG1TC Cabin Air Filter.....	CA-27040	Air Filter Set.....	A-2709M-S	ZX180LCN-3 (EXCAVATORS) ISUZU AI-4JJ1X Cabin Air Filter.....	CA-27030
ZX160 (EXCAVATORS) Air Filter Primary.....	A-5541	Fuel Filter.....	FC-1005	ZX190W-3 (EXCAVATORS) ISUZU AI-4HK1X Cabin Air Filter.....	CA-27030
Air Filter Primary.....	A-5541M	Fuel Filter.....	FC-1801	ZX125US (EXCAVATORS) ISUZU 4BG1T Cabin Air Filter.....	CA-27040
Air Filter Primary.....	A-76231			Oil Filter Combination.....	C-2704
Air Filter Secondary.....	A-5540			ZX135US-E (EXCAVATORS) ISUZU 4BG1T Cabin Air Filter.....	CA-27040
Air Filter Set.....	A-5541M-S			Oil Filter Combination.....	C-2704
ZX160 (EXCAVATORS) W/ISUZU AA-4BG1TC ENG. Cabin Air Filter.....	CA-27050	ZX170-2 (EXCAVATORS) YANMAR 3TNV70-VHB (S/N: 010001-UP) , 2007 Hydraulic Oil Filter.....	H-2712	ZX130-5 (EXCAVATORS) ISUZU 4JJ1 Fuel Filter.....	F-7930
Oil Filter Combination.....	C-2704	ZX160LC (EXCAVATORS) ISUZU CC-4BG1TC Cabin Air Filter.....	CA-27040	ZX180LC-5 (EXCAVATORS) ISUZU 4JJ1 Fuel Filter.....	F-7930
ZX160LC (EXCAVATORS) ISUZU 4BG1 Fuel Filter.....	FC-1824	ZX160LC (EXCAVATORS) W/ISUZU CC-4BG1TC ENG. Cabin Air Filter.....	CA-27050	ZX190W-5 (EXCAVATORS) ISUZU 4HK1 Fuel Filter.....	F-7930
ZX160LC (EXCAVATORS) ISUZU AA-4BG1TC (S/N: 005001-UP) Air Filter Primary.....	A-5541	ZX110M-3 (EXCAVATORS) ISUZU AJ-4JJ1X Cabin Air Filter.....	CA-27030	ZX200-3 (EXCAVATORS) ISUZU AH-4HK1XYS-02 , 2008 Air Filter Primary.....	A-5539
Air Filter Primary.....	A-5541M	Cabin Air Filter.....	CA-27040	Air Filter Primary.....	A-5539M
Air Filter Primary.....	A-76231	Cabin Air Filter.....	CA-27040	Air Filter Secondary.....	A-5538
Air Filter Secondary.....	A-5540	Oil Filter Combination.....	C-2704	Air Filter Set.....	A-2709-S
Air Filter Set.....	A-5541M-S	ZX130K-3 (EXCAVATORS) ISUZU AJ-4JJ1X Cabin Air Filter.....	CA-27030	Air Filter Set.....	A-2709M-S
Fuel Filter.....	FC-1005	Cabin Air Filter.....	CA-27040	Cabin Air Filter.....	CA-27020
Fuel Filter.....	FC-1801	Oil Filter Combination.....	C-2704	Cabin Air Filter.....	CA-27021
Hydraulic Oil Filter.....	H-2703	ZX135US-3 (EXCAVATORS) ISUZU 4JJ1X Cabin Air Filter.....	CA-27040	ZX200-3 (EXCAVATORS) ISUZU 4HK1 Fuel Filter.....	F-7914
ZX160LC (EXCAVATORS) ISUZU AA-4BG1TC Cabin Air Filter.....	CA-27040	ZX140W-3 (EXCAVATORS) ISUZU AI-4JJ1X Cabin Air Filter.....	CA-27030	ZX200-3 (EXCAVATORS) ISUZU 4HK1X Cabin Air Filter.....	CA-27030
ZX160LC (EXCAVATORS) Air Filter Primary.....	A-2708	Cabin Air Filter.....	CA-27040	ZX200LC-3 (EXCAVATORS) ISUZU AH-4HK1XYS-02 , 2008 Cabin Air Filter.....	CA-27020
Air Filter Secondary.....	A-7956	Oil Filter Combination.....	C-2704	Cabin Air Filter.....	CA-27021
Air Filter Set.....	A-2711-S	ZX145W-3 (EXCAVATORS) w/Isuzu AI-4JJ1X Eng. Oil Filter Combination.....	C-2704	ZX200LC-3 (EXCAVATORS) ISUZU 4HK1 Hydraulic Oil Filter.....	H-27360
Hydraulic Oil Filter.....	H-2703	ZX145W-3 (EXCAVATORS) w/Isuzu AI-4JJ1X Eng. Oil Filter Combination.....	C-2704	ZX200LC-3 (EXCAVATORS) ISUZU 4HK1X Cabin Air Filter.....	CA-27030
ZX160LC (EXCAVATORS) W/ISUZU AA-4BG1TC ENG. Cabin Air Filter.....	CA-27050	ZX160LC-3 (EXCAVATORS) ISUZU AI-4JJ1X Cabin Air Filter.....	CA-27030	ZX210H-3 (EXCAVATORS) ISUZU 4HK1-XYS-02 Air Filter Primary.....	A-5539
Oil Filter Combination.....	C-2704	Cabin Air Filter.....	CA-27040	Air Filter Primary.....	A-5539M
ZX160W (EXCAVATORS) ISUZU 4BG1T Cabin Air Filter.....	CA-27040	Oil Filter Combination.....	C-2704	Air Filter Secondary.....	A-5538
ZX160W (EXCAVATORS) ISUZU 4BG1TC (S/N: 002002-UP) Air Filter Primary.....	A-5539	ZX160LC-3 (EXCAVATORS) ISUZU AI-4JJ1X Cabin Air Filter.....	CA-27030	Air Filter Set.....	A-2709-S
Air Filter Primary.....	A-5539M	ZX170W-3 (EXCAVATORS) ISUZU AI-4HK1X Cabin Air Filter.....	CA-27030	Air Filter Set.....	A-2709M-S
Air Filter Secondary.....	A-5538	Cabin Air Filter.....	CA-27040		
Air Filter Set.....	A-2709-S				
Air Filter Set.....	A-2709M-S				
ZX160W (EXCAVATORS) Air Filter Primary.....	A-5539				
Air Filter Primary.....	A-5539M				
Air Filter Secondary.....	A-5538				
Air Filter Set.....	A-2709-S				
Air Filter Set.....	A-2709M-S				

Sakura Filter

ENGINE APPLICATION

MODEL/APPLICATION	SAKURA NO	MODEL/APPLICATION	SAKURA NO	MODEL/APPLICATION	SAKURA NO
HITACHI		HITACHI		HITACHI	
ZX210H-3 (EXCAVATORS) ISUZU 4HK1-XYSA-02		ZX240LC-3 (EXCAVATORS) ISUZU AH 4HK1 XYSA/20001 , 2006		ZX250K-3 (EXCAVATORS) ISUZU AH-4HK1X	
Cabin Air Filter.....	CA-27020	Cabin Air Filter.....	CA-27020	Cabin Air Filter.....	CA-27030
Cabin Air Filter.....	CA-27021	Cabin Air Filter.....	CA-27021		
ZX210H-3 (EXCAVATORS) ISUZU 4HK1X		ZX240LC-3 (EXCAVATORS) ISUZU AI-4HK1X		ZX250LC-3 (EXCAVATORS) ISUZU AH 4HK1 XYSA/20001 , 2006	
Cabin Air Filter.....	CA-27030	Cabin Air Filter.....	CA-27030	Cabin Air Filter.....	CA-27020
				Cabin Air Filter.....	CA-27021
ZX210K-3 (EXCAVATORS) ISUZU 4HK1-XYSA-02		ZX240LC-3 (EXCAVATORS) ISUZU AH4HK		ZX250LC-3 (EXCAVATORS) ISUZU AH 4HK1 XYSA (S/N: 020001-UP) , 2006	
Cabin Air Filter.....	CA-27020	Cabin Air Filter.....	CA-27030	Air Filter Primary.....	A-5539
Cabin Air Filter.....	CA-27021	Hydraulic Oil Filter.....	H-27360	Air Filter Primary.....	A-5539M
				Air Filter Secondary.....	A-5538
ZX210LCH-3 (EXCAVATORS) ISUZU 4HK1-XYSA-02		ZX240LC-3 (EXCAVATORS) ISUZU AH-4HK1X		Air Filter Set.....	A-2709-S
Cabin Air Filter.....	CA-27020	Hydraulic Oil Filter.....	H-27360	Air Filter Set.....	A-2709M-S
Cabin Air Filter.....	CA-27021				
ZX210LCH-3 (EXCAVATORS) ISUZU 4HK1		ZX250-3 (EXCAVATORS) ISUZU AH-4HK1XYSA-01 , 2006		ZX250LC-3 (EXCAVATORS) ISUZU AH-4HK1X	
Hydraulic Oil Filter.....	H-27360	Air Filter Primary.....	A-5539	Cabin Air Filter.....	CA-27030
		Air Filter Primary.....	A-5539M		
ZX210LCH-3 (EXCAVATORS) ISUZU 4HK1X		Air Filter Secondary.....	A-5538	ZX250LCH-3 (EXCAVATORS) ISUZU AH 4HK1 XYSA/20001 , 2006	
Cabin Air Filter.....	CA-27030	Air Filter Set.....	A-2709-S	Cabin Air Filter.....	CA-27020
		Air Filter Set.....	A-2709M-S	Cabin Air Filter.....	CA-27021
ZX210LCK-3 (EXCAVATORS) ISUZU 4HK1-XYSA-02		Cabin Air Filter.....	CA-27020	ZX250LCH-3 (EXCAVATORS) ISUZU AH4HK	
Air Filter Primary.....	A-5539	Cabin Air Filter.....	CA-27021	Hydraulic Oil Filter.....	H-27360
Air Filter Primary.....	A-5539M				
Air Filter Secondary.....	A-5538	ZX250H-3 (EXCAVATORS) ISUZU AH 4HK1 XYSA/20001 , 2006		ZX250LCH-3 (EXCAVATORS) ISUZU AH-4HK1X	
Air Filter Set.....	A-2709-S	Cabin Air Filter.....	CA-27020	Cabin Air Filter.....	CA-27030
Air Filter Set.....	A-2709M-S	Cabin Air Filter.....	CA-27021		
Cabin Air Filter.....	CA-27020			ZX250LCH-3 (EXCAVATORS) ISUZU AH-4HK1XYSA	
Cabin Air Filter.....	CA-27021			Hydraulic Oil Filter.....	H-27360
ZX210LCK-3 (EXCAVATORS) ISUZU 4HK1		ZX250H-3 (EXCAVATORS) ISUZU AH 4HK1 XYSA (S/N: 020001-UP) , 2006		ZX250LCK-3 (EXCAVATORS) ISUZU AH 4HK1 XYSA/20001 , 2006	
Hydraulic Oil Filter.....	H-27360	Cabin Air Filter.....	CA-27020	Cabin Air Filter.....	CA-27020
		Cabin Air Filter.....	CA-27021	Cabin Air Filter.....	CA-27021
ZX210LCK-3 (EXCAVATORS) ISUZU 4HK1X		ZX250H-3 (EXCAVATORS) ISUZU AH 4HK1 XYSA (S/N: 020001-UP) , 2006		ZX250LCK-3 (EXCAVATORS) ISUZU AH4HK	
Cabin Air Filter.....	CA-27030	Air Filter Primary.....	A-5539	Hydraulic Oil Filter.....	H-27360
		Air Filter Primary.....	A-5539M		
ZX240-3 (EXCAVATORS) ISUZU AH 4HK1 XYSA/20001 , 2006		Air Filter Secondary.....	A-5538	ZX250LCK-3 (EXCAVATORS) ISUZU AH-4HK1X	
Cabin Air Filter.....	CA-27020	Air Filter Set.....	A-2709-S	Cabin Air Filter.....	CA-27030
Cabin Air Filter.....	CA-27021	Air Filter Set.....	A-2709M-S		
ZX240-3 (EXCAVATORS) ISUZU AH 4HK1 XYSA (S/N: 020001-UP) , 2006		Cabin Air Filter.....	CA-27030	ZX250LCN-3 (EXCAVATORS) ISUZU AH 4HK1 XYSA/20001 , 2006	
Air Filter Primary.....	A-5539			Cabin Air Filter.....	CA-27020
Air Filter Primary.....	A-5539M	ZX250K-3 (EXCAVATORS) ISUZU AH 4HK1 XYSA/20001 , 2006		Cabin Air Filter.....	CA-27021
Air Filter Secondary.....	A-5538	Cabin Air Filter.....	CA-27020		
Air Filter Set.....	A-2709-S	Cabin Air Filter.....	CA-27021	ZX250LCN-3 (EXCAVATORS) ISUZU AH4HK	
Air Filter Set.....	A-2709M-S			Hydraulic Oil Filter.....	H-27360
ZX240-3 (EXCAVATORS) ISUZU 4HK1		ZX250K-3 (EXCAVATORS) ISUZU AH 4HK1 XYSA (S/N: 020001-UP) , 2006		ZX250LCN-3 (EXCAVATORS) ISUZU AH-4HK1X	
Cabin Air Filter.....	CA-27030	Air Filter Primary.....	A-5539	Cabin Air Filter.....	CA-27030
Hydraulic Oil Filter.....	H-27360	Air Filter Primary.....	A-5539M		
ZX240-3 (EXCAVATORS) ISUZU AI-4HK1X		Air Filter Secondary.....	A-5538	ZX270-3 (EXCAVATORS) ISUZU ISUZU/30001 , 2006	
Cabin Air Filter.....	CA-27030	Air Filter Set.....	A-2709-S	Cabin Air Filter.....	CA-27020
		Air Filter Set.....	A-2709M-S	Cabin Air Filter.....	CA-27021

Sakura Filter

ENGINE APPLICATION

MODEL/APPLICATION	SAKURA NO	MODEL/APPLICATION	SAKURA NO	MODEL/APPLICATION	SAKURA NO
HITACHI		HITACHI		HITACHI	
ZX270-3 (EXCAVATORS) ISUZU (S/N: 030001-UP) , 2006		Cabin Air Filter.....	CA-27040	ZX210W-3 (EXCAVATORS) ISUZU AI-4HK1X	
Air Filter Primary.....	A-5539	Fuel Filter.....	FC-15031	Cabin Air Filter.....	CA-27030
Air Filter Primary.....	A-5539M	ZX200LC-E (EXCAVATORS) ISUZU 6BG1		ZX230 (EXCAVATORS) ISUZU 6BG1T	
Air Filter Secondary.....	A-5538	Cabin Air Filter.....	CA-27040	Cabin Air Filter.....	CA-27040
Air Filter Set.....	A-2709-S	Fuel Filter.....	FC-15031	Fuel Filter.....	FC-15031
Air Filter Set.....	A-2709M-S	ZX210 (EXCAVATORS) ISUZU 6BG1T		ZX230 (EXCAVATORS) ISUZU CC6BG1TRA01	
ZX270-3 (EXCAVATORS) ISUZU AH-4HK1X		Cabin Air Filter.....	CA-27040	Air Filter Primary.....	A-5539
Cabin Air Filter.....	CA-27030	Fuel Filter.....	FC-15031	Air Filter Primary.....	A-5539M
ZX270LC-3 (EXCAVATORS) ISUZU ISUZU/30001 , 2006		ZX210 (EXCAVATORS)		Air Filter Secondary.....	A-5538
Cabin Air Filter.....	CA-27020	Air Filter Primary.....	A-5539	Air Filter Set.....	A-2709-S
Cabin Air Filter.....	CA-27021	Air Filter Primary.....	A-5539M	Air Filter Set.....	A-2709M-S
ZX270LC-3 (EXCAVATORS) ISUZU AH-4HK1X		Air Filter Secondary.....	A-5538	Fuel Filter.....	FC-1005
Cabin Air Filter.....	CA-27030	Air Filter Set.....	A-2709-S	Fuel Filter.....	FC-1503
ZX280LC-3 (EXCAVATORS) ISUZU ISUZU/30001 , 2006		Air Filter Set.....	A-2709M-S	Hydraulic Oil Filter.....	H-2703
Cabin Air Filter.....	CA-27020	Fuel Filter.....	FC-1005	Hydraulic Oil Filter Return.....	H-7981
Cabin Air Filter.....	CA-27021	Fuel Filter.....	FC-1503	Hydraulic Oil Filter Suction.....	H-2706
ZX280LC-3 (EXCAVATORS) ISUZU (S/N: 030001-UP) , 2006		Hydraulic Oil Filter.....	H-2703	ZX230LC (EXCAVATORS) ISUZU 6BG1	
Air Filter Primary.....	A-5539	Hydraulic Oil Filter Return.....	H-7981	Fuel Filter.....	FC-15031
Air Filter Primary.....	A-5539M	Hydraulic Oil Filter Suction.....	H-2706	ZX240 (EXCAVATORS) ISUZU 6BG1	
Air Filter Secondary.....	A-5538	ZX210-3 (EXCAVATORS)		Air Filter Primary.....	A-5539
Air Filter Set.....	A-2709-S	Air Filter Primary.....	A-5539	Air Filter Primary.....	A-5539M
Air Filter Set.....	A-2709M-S	Air Filter Primary.....	A-5539M	Air Filter Secondary.....	A-5538
ZX280LCH-3 (EXCAVATORS) ISUZU ISUZU/30001 , 2006		Air Filter Secondary.....	A-5538	Air Filter Set.....	A-2709-S
Cabin Air Filter.....	CA-27020	Air Filter Set.....	A-2709M-S	Air Filter Set.....	A-2709M-S
Cabin Air Filter.....	CA-27021	Fuel Filter.....	FC-1005	Fuel Filter.....	FC-1005
ZX280LCH-3 (EXCAVATORS) ISUZU AH-4HK1X		Fuel Filter.....	FC-1503	Fuel Filter.....	FC-1503
Cabin Air Filter.....	CA-27030	Hydraulic Oil Filter.....	H-2703	Hydraulic Oil Filter.....	H-2703
ZX280LCN-3 (EXCAVATORS) ISUZU ISUZU/30001 , 2006		Hydraulic Oil Filter Return.....	H-7981	Hydraulic Oil Filter Return.....	H-7981
Cabin Air Filter.....	CA-27020	Hydraulic Oil Filter Suction.....	H-2706	Hydraulic Oil Filter Suction.....	H-2706
Cabin Air Filter.....	CA-27021	ZX210LCH (EXCAVATORS) ISUZU 6BG1T		ZX240H (EXCAVATORS) ISUZU 6BG1T	
ZX280LCN-3 (EXCAVATORS) ISUZU AH-4HK1X		Cabin Air Filter.....	CA-27040	Fuel Filter.....	FC-15031
Cabin Air Filter.....	CA-27030	ZX210LCH (EXCAVATORS) ISUZU 6BG1		ZX240K (EXCAVATORS) ISUZU 6BG1T	
ZX280LCN-3 (EXCAVATORS) ISUZU 6BG1TRA , 2002		Fuel Filter.....	FC-15031	Cabin Air Filter.....	CA-27040
Air Filter Primary.....	A-5539	ZX210LCK (EXCAVATORS) ISUZU 6BG1T		ZX240K (EXCAVATORS) ISUZU CC-6BG1T	
Air Filter Primary.....	A-5539M	Cabin Air Filter.....	CA-27040	Fuel Filter.....	FC-15031
Air Filter Secondary.....	A-5538	ZX210LCK (EXCAVATORS) ISUZU 6BG1		ZX240LC (EXCAVATORS) ISUZU 6BG1	
Air Filter Set.....	A-2709-S	Fuel Filter.....	FC-15031	Fuel Filter.....	FC-15031
Air Filter Set.....	A-2709M-S	ZX210W (EXCAVATORS) ISUZU 6BG1T		Cabin Air Filter.....	CA-27040
Fuel Filter.....	FC-1005	Cabin Air Filter.....	CA-27040	ZX240K (EXCAVATORS) ISUZU 6BG1T	
Fuel Filter.....	FC-1503	Fuel Filter.....	FC-15031	Fuel Filter.....	FC-15031
Hydraulic Oil Filter.....	H-2703	ZX210W (EXCAVATORS) ISUZU AA-6BG1T		ZX240LC (EXCAVATORS) ISUZU 6BG1	
Hydraulic Oil Filter Return.....	H-7981	Air Filter Primary.....	A-5539	Fuel Filter.....	FC-15031
Hydraulic Oil Filter Suction.....	H-2706	Air Filter Primary.....	A-5539M	ZX240LCK (EXCAVATORS) ISUZU 6BG1	
ZX200LC (EXCAVATORS) ISUZU 6BG1		Air Filter Secondary.....	A-5538	Fuel Filter.....	FC-15031
Air Filter Primary.....	A-5539	Air Filter Set.....	A-2709-S	ZX25 (EXCAVATORS) ISUZU 3YE1	
Air Filter Primary.....	A-5539M	Air Filter Set.....	A-2709M-S	Fuel Filter.....	F-5207
Air Filter Secondary.....	A-5538	Fuel Filter.....	FC-1005	Hydraulic Oil Filter.....	H-2712
Air Filter Set.....	A-2709-S	Fuel Filter.....	FC-1503	Hydraulic Oil Filter.....	HC-5807
Air Filter Set.....	A-2709M-S	Hydraulic Oil Filter Return.....	H-7981		
Fuel Filter.....	FC-1005	Hydraulic Oil Filter Suction.....	H-2706		
Fuel Filter.....	FC-1503				
Hydraulic Oil Filter.....	H-2703				
Hydraulic Oil Filter Return.....	H-7981				
Hydraulic Oil Filter Suction.....	H-2706				
ZX200LC (EXCAVATORS) ISUZU 6BG1					
Air Filter Primary.....	A-5539				
Air Filter Primary.....	A-5539M				
Air Filter Secondary.....	A-5538				
Air Filter Set.....	A-2709-S				
Air Filter Set.....	A-2709M-S				
Fuel Filter.....	FC-1005				
Fuel Filter.....	FC-1503				
Hydraulic Oil Filter.....	H-2703				
Hydraulic Oil Filter Return.....	H-7981				
Hydraulic Oil Filter Suction.....	H-2706				

MODEL/APPLICATION	SAKURA NO	MODEL/APPLICATION	SAKURA NO	MODEL/APPLICATION	SAKURA NO
HITACHI		HITACHI		HITACHI	
ZX250 (EXCAVATORS) ISUZU , 2005		Air Filter Primary.....	A-8513	Air Filter Primary.....	A-5539M
Air Filter Primary.....	A-5539	Air Filter Secondary.....	A-5569	Air Filter Secondary.....	A-5538
Air Filter Primary.....	A-5539M	Hydraulic Oil Filter.....	H-2712	Air Filter Set.....	A-2709-S
Air Filter Secondary.....	A-5538			Air Filter Set.....	A-2709M-S
Air Filter Set.....	A-2709-S	ZX280-3 (EXCAVATORS) 2007		ZX225US-E (EXCAVATORS) ISUZU 6BG1TRA03	
Air Filter Set.....	A-2709M-S	Air Filter Primary.....	A-5539	Air Filter Primary.....	A-5539
Fuel Filter.....	FC-1005	Air Filter Primary.....	A-5539M	Air Filter Primary.....	A-5539M
Fuel Filter.....	FC-1503	Air Filter Secondary.....	A-5538	Air Filter Secondary.....	A-5538
Hydraulic Oil Filter.....	H-2703	Air Filter Set.....	A-2709-S	Air Filter Secondary.....	A-5538
Hydraulic Oil Filter Return.....	H-7981	Air Filter Set.....	A-2709M-S	Air Filter Set.....	A-2709-S
Hydraulic Oil Filter Suction.....	H-2706			Air Filter Set.....	A-2709M-S
		ZX280LC (EXCAVATORS) ISUZU 6BG1TRA02 (S/N: 020001-UP) , 2006		Fuel Filter.....	FC-1005
ZX250LC (EXCAVATORS) ISUZU CC-6BG1T		Air Filter Primary.....	A-5539	Fuel Filter.....	FC-1503
Cabin Air Filter.....	CA-27040	Air Filter Primary.....	A-5539M	Hydraulic Oil Filter.....	H-2703
		Air Filter Secondary.....	A-5538	Hydraulic Oil Filter Suction.....	H-2706
ZX250LCN (EXCAVATORS) ISUZU CC 6BG1 (S/N: 010001-UP) , 2006		Air Filter Set.....	A-2709-S	ZX225USR (EXCAVATORS) ISUZU 6BG1T , 2002	
Air Filter Primary.....	A-5539	Air Filter Set.....	A-2709M-S	Air Filter Primary.....	A-5539
Air Filter Primary.....	A-5539M	Air Filter Set.....	A-2709M-S	Air Filter Primary.....	A-5539M
Air Filter Secondary.....	A-5538	Fuel Filter.....	FC-1005	Air Filter Secondary.....	A-5538
Air Filter Set.....	A-2709-S	Fuel Filter.....	FC-1503	Air Filter Set.....	A-2709-S
Air Filter Set.....	A-2709M-S	Hydraulic Oil Filter.....	H-2703	Air Filter Set.....	A-2709M-S
Fuel Filter.....	FC-1005	Hydraulic Oil Filter Return.....	H-7981	Fuel Filter.....	FC-1503
Fuel Filter.....	FC-1503	Hydraulic Oil Filter Suction.....	H-2706	Hydraulic Oil Filter.....	H-2703
Hydraulic Oil Filter.....	H-2703			Hydraulic Oil Filter Return.....	H-7981
Hydraulic Oil Filter Suction.....	H-2706	ZX280LC (EXCAVATORS) ISUZU 6BG1T		Hydraulic Oil Filter Suction.....	H-2706
		Cabin Air Filter.....	CA-27040	ZX225USR (EXCAVATORS) ISUZU 6BG1T	
ZX250LCN (EXCAVATORS) ISUZU 6BG1		Fuel Filter.....	FC-15031	Fuel Filter.....	FC-15031
Fuel Filter.....	FC-15031			ZX225USR (EXCAVATORS) ISUZU 6BG1	
ZX250LCN (EXCAVATORS) ISUZU CC-6BG1T		ZX280LCN (EXCAVATORS) ISUZU 6BG1		Cabin Air Filter.....	CA-27040
Cabin Air Filter.....	CA-27040	Fuel Filter.....	FC-15031		
ZX270 (EXCAVATORS) ISUZU 6BG1T		ZX280LCN (EXCAVATORS) ISUZU 6BG1		ZX225USR-3 (EXCAVATORS) ISUZU 4HK1-XYSA-02 , 2008	
Fuel Filter.....	FC-15031	Fuel Filter.....	FC-15031	Air Filter Primary.....	A-5539
ZX270 (EXCAVATORS) ISUZU 6BG1		ZX210LC III (EXCAVATORS) 2007		Air Filter Primary.....	A-5539M
Cabin Air Filter.....	CA-27040	Air Filter Primary.....	A-5539	Air Filter Primary.....	A-5539M
ZX270 (EXCAVATORS) ISUZU 6BG1TRA02		Air Filter Primary.....	A-5539M	Air Filter Secondary.....	A-5538
Air Filter Primary.....	A-5539	Air Filter Secondary.....	A-5538	Air Filter Set.....	A-2709-S
Air Filter Primary.....	A-5539M	Air Filter Set.....	A-2709-S	Air Filter Set.....	A-2709M-S
Air Filter Secondary.....	A-5538	Air Filter Set.....	A-2709M-S		
Air Filter Set.....	A-2709-S	ZX225US (EXCAVATORS) ISUZU 6BG1		ZX225USRK-3 (EXCAVATORS) ISUZU 4HK1-XYSA-02	
Air Filter Set.....	A-2709M-S	Cabin Air Filter.....	CA-27040	Air Filter Primary.....	A-5539
Fuel Filter.....	FC-1005	ZX225US (EXCAVATORS) ISUZU 6BG1TRA03		Air Filter Primary.....	A-5539M
Fuel Filter.....	FC-1503	Air Filter Primary.....	A-5539	Air Filter Secondary.....	A-5538
Hydraulic Oil Filter.....	H-2703	Air Filter Primary.....	A-5539M	Air Filter Set.....	A-2709-S
Hydraulic Oil Filter.....	H-2709	Air Filter Secondary.....	A-5538	Air Filter Set.....	A-2709M-S
Hydraulic Oil Filter Return.....	H-7981	Air Filter Set.....	A-2709-S		
Hydraulic Oil Filter Suction.....	H-2706	Air Filter Set.....	A-2709M-S	ZX225USRK-3 (EXCAVATORS) ISUZU 4HK1X	
		Fuel Filter.....	FC-1005	Cabin Air Filter.....	CA-27040
ZX270LC (EXCAVATORS) ISUZU 6BG1		Hydraulic Oil Filter.....	H-2703	ZX200-5G (EXCAVATORS) ISUZU CC-6BG1T	
Cabin Air Filter.....	CA-27040	Hydraulic Oil Filter Return.....	H-7981	Cabin Air Filter.....	CA-27060
Fuel Filter.....	FC-15031	Hydraulic Oil Filter Suction.....	H-2706	ZX210LCH-5G (EXCAVATORS) ISUZU AH-4HK1XYSA-01	
ZX270-2 (EXCAVATORS) YANMAR 3TNV88 (S/N: 010001-UP) , 2006		ZX225US-3 (EXCAVATORS) ISUZU 4HK1-XYSA-02 , 2008		Cabin Air Filter.....	CA-27060
		Air Filter Primary.....	A-5539	ZX200 (EXCAVATORS) ISUZU 6BG1T	

Sakura Filter

ENGINE APPLICATION

MODEL/APPLICATION	SAKURA NO	MODEL/APPLICATION	SAKURA NO	MODEL/APPLICATION	SAKURA NO
HITACHI		HITACHI		HITACHI	
ZX200 (EXCAVATORS) ISUZU 6BG1T Fuel Filter.....	FC-15031	Fuel Filter.....	FC-15031	Cabin Air Filter.....	CA-27021
ZX200 (EXCAVATORS) ISUZU 6BG1 Cabin Air Filter.....	CA-27040	ZX225USLC-E (EXCAVATORS) ISUZU 6BG1 Fuel Filter.....	FC-15031	ZX330LC-3 (EXCAVATORS) ISUZU AH-6HK1X Cabin Air Filter.....	CA-27030
ZX210H (EXCAVATORS) ISUZU 6BG1T Cabin Air Filter.....	CA-27040	ZX330-3 (EXCAVATORS) 2008 Air Filter Primary.....	A-8650	ZX330LC-3 (EXCAVATORS) ISUZU 6HK1 Hydraulic Oil Filter.....	H-27360
ZX210K (EXCAVATORS) ISUZU 6BG1T Cabin Air Filter.....	CA-27040	Air Filter Secondary.....	A-8651	ZX330LC-3 (EXCAVATORS) ISUZU 6WG1 Cabin Air Filter.....	CA-27030
ZX210LC (EXCAVATORS) ISUZU 6BG1T Cabin Air Filter.....	CA-27040	Air Filter Set.....	A-8652-S	Hydraulic Oil Filter.....	H-27360
ZX225USLC (EXCAVATORS) ISUZU 6BG1T Fuel Filter.....	FC-15031	Hydraulic Oil Filter.....	H-2724	ZX350-3 (EXCAVATORS) ISUZU AH-6HK1XYSA-01 , 2008 Air Filter Primary.....	AS-5102
ZX225USLC (EXCAVATORS) ISUZU 6BG1 Fuel Filter.....	FC-15031	Hydraulic Oil Filter.....	HC-2709	Air Filter Secondary.....	A-8651
ZX225USLC-3 (EXCAVATORS) ISUZU 4HK1 Hydraulic Oil Filter.....	H-27360	Oil Filter Combination.....	C-2708	Air Filter Set.....	AS-5102-S
ZX225USRK (EXCAVATORS) ISUZU 6BG1 Cabin Air Filter.....	CA-27040	ZX330-3 (EXCAVATORS) ISUZU AH 6HK1 XYSA (S/N: 050001-UP) , 2006 Air Filter Primary.....	AS-5102	Cabin Air Filter.....	CA-27020
ZX225USRLC (EXCAVATORS) ISUZU 6BG1T Fuel Filter.....	FC-15031	Air Filter Secondary.....	A-8651	Cabin Air Filter.....	CA-27021
ZX225USRLC-3 (EXCAVATORS) ISUZU 4HK1 Hydraulic Oil Filter.....	H-27360	Air Filter Set.....	AS-5102-S	ZX350K-3 (EXCAVATORS) ISUZU AH 6HK1 XYSA (S/N: 050001-UP) , 2006 Air Filter Primary.....	AS-5102
ZX225USRLC-E (EXCAVATORS) ISUZU 6BG1T Fuel Filter.....	FC-15031	Cabin Air Filter.....	CA-27020	Air Filter Secondary.....	A-8651
ZX225USRLCK (EXCAVATORS) ISUZU 6BG1T Fuel Filter.....	FC-15031	Cabin Air Filter.....	CA-27021	Air Filter Set.....	AS-5102-S
ZX225USRKLC-3 (EXCAVATORS) ISUZU 4HK1 Hydraulic Oil Filter.....	H-27360	ZX350H-3 (EXCAVATORS) 2008 Air Filter Primary.....	A-8650	Cabin Air Filter.....	CA-27020
ZX210-5 (EXCAVATORS) ISUZU CC-6BG1 Fuel Filter.....	F-7930	Air Filter Secondary.....	A-8651	Cabin Air Filter.....	CA-27021
ZX250LC-5 (EXCAVATORS) ISUZU 4HK1ZXSA-01 Fuel Filter.....	F-7930	Air Filter Set.....	A-8652-S	ZX350K-3 (EXCAVATORS) ISUZU AH-6HK1X Cabin Air Filter.....	CA-27030
ZX290LC-5 (EXCAVATORS) ISUZU AH-4K1X Fuel Filter.....	F-7930	Hydraulic Oil Filter.....	H-2724	ZX350LCH-3 (EXCAVATORS) ISUZU AH-6HK1X Cabin Air Filter.....	CA-27030
ZX225USLC-E (EXCAVATORS) ISUZU 6BG1T		Hydraulic Oil Filter.....	HC-2709	ZX350LCH-3 (EXCAVATORS) ISUZU 6HK1 Hydraulic Oil Filter.....	H-27360
		Oil Filter Combination.....	C-2708	ZX350LCK-3 (EXCAVATORS) ISUZU AH 6HK1 XYSA (S/N: 050001-UP) , 2006 Air Filter Primary.....	AS-5102
		ZX350H-3 (EXCAVATORS) ISUZU AH 6HK1 XYSA (S/N: 050001-UP) , 2006 Air Filter Primary.....	AS-5102	Air Filter Set.....	AS-5102-S
		Air Filter Secondary.....	A-8651	Cabin Air Filter.....	CA-27020
		Air Filter Set.....	AS-5102-S	Cabin Air Filter.....	CA-27021
		Cabin Air Filter.....	CA-27020	ZX350LCK-3 (EXCAVATORS) ISUZU AH 6HK1 XYSA (S/N: 050001-UP) , 2006 Air Filter Primary.....	AS-5102
		Cabin Air Filter.....	CA-27021	Air Filter Set.....	AS-5102-S
		ZX350H-3 (EXCAVATORS) ISUZU AH-6HK1X Cabin Air Filter.....	CA-27030	Cabin Air Filter.....	CA-27020
		ZX350LC (EXCAVATORS) W/ISUZU AA-6HK1 ENG. Cabin Air Filter.....	CA-27050	Cabin Air Filter.....	CA-27021
		ZX330LC-3 (EXCAVATORS) ISUZU AH 6HK1 XYSA (S/N: 050001-UP) , 2006 Air Filter Primary.....	AS-5102	ZX350LCK-3 (EXCAVATORS) ISUZU AH-6HK1X Cabin Air Filter.....	CA-27030
		Air Filter Secondary.....	AS-5102-S	ZX350LCK-3 (EXCAVATORS) ISUZU 6HK1 Hydraulic Oil Filter.....	H-27360
		Cabin Air Filter.....	CA-27020		

Sakura Filter

ENGINE APPLICATION

MODEL/APPLICATION	SAKURA NO	MODEL/APPLICATION	SAKURA NO	MODEL/APPLICATION	SAKURA NO
HITACHI		HITACHI		HITACHI	
ZX350LCN-3 (EXCAVATORS) ISUZU AH 6HK1 XYS/50001 , 2006		Fuel Filter..... FC-1005		Air Filter Set..... AS-5102-S	
Air Filter Primary..... AS-5102		Fuel Filter..... FC-2703		ZX370 (EXCAVATORS) ISUZU 6HK1X	
Air Filter Set..... AS-5102-S		Hydraulic Oil Filter..... H-2703		Cabin Air Filter..... CA-27040	
Cabin Air Filter..... CA-27020		Hydraulic Oil Filter Return..... H-7981		ZX370 (EXCAVATORS) ISUZU AA-6HK1X	
Cabin Air Filter..... CA-27021		Hydraulic Oil Filter Suction..... H-2706		Cabin Air Filter..... CA-27040	
ZX350LCN-3 (EXCAVATORS) ISUZU AH-6HK1X		ZX350H (EXCAVATORS) ISUZU AA-6HK1XQA , 2002		Cabin Air Filter..... CA-27040	
Cabin Air Filter..... CA-27030		Air Filter Primary..... AS-5102		ZX370 (EXCAVATORS) W/ISUZU AA-6HK1X ENG.	
ZX350LCN-3 (EXCAVATORS) ISUZU 6HK1		Air Filter Set..... AS-5102-S		Cabin Air Filter..... CA-27050	
Hydraulic Oil Filter..... H-27360		ZX350H (EXCAVATORS) ISUZU AA-6HK1		ZX370MTH (EXCAVATORS) ISUZU AA-6HK1XQA , 2002	
ZX350LCN-3 (EXCAVATORS) ISUZU 6WG1		Cabin Air Filter..... CA-27040		Air Filter Primary..... AS-5102	
Cabin Air Filter..... CA-27030		ZX350H (EXCAVATORS) W/ISUZU AA-6HK1 ENG.		Air Filter Set..... AS-5102-S	
Hydraulic Oil Filter..... H-27360		Cabin Air Filter..... CA-27050		ZX370MTH (EXCAVATORS) ISUZU 6HK1X	
ZX350N-3 (EXCAVATORS) ISUZU AH 6HK1 XYS/50001 , 2006		ZX350K (EXCAVATORS) ISUZU AA-6HK1XQA , 2002		Cabin Air Filter..... CA-27040	
Air Filter Primary..... AS-5102		Air Filter Primary..... AS-5102		ZX370MTH (EXCAVATORS) ISUZU AA-6HK1X	
Air Filter Set..... AS-5102-S		Air Filter Set..... AS-5102-S		Cabin Air Filter..... CA-27040	
Cabin Air Filter..... CA-27020		ZX350K (EXCAVATORS) ISUZU AA-6HK1		ZX370MTH (EXCAVATORS) W/ISUZU AA-6HK1X ENG.	
Cabin Air Filter..... CA-27021		Cabin Air Filter..... CA-27040		Cabin Air Filter..... CA-27050	
ZX350N-3 (EXCAVATORS) ISUZU AH 6HK1 XYS (S/N: 050001-UP) , 2006		ZX350K (EXCAVATORS) W/ISUZU AA-6HK1 ENG.		ZX30 (EXCAVATORS) KUBOTA V1505	
Air Filter Primary..... AS-5102		Cabin Air Filter..... CA-27050		Air Filter Primary..... A-8513	
Air Filter Secondary..... A-8651		ZX350LC-3 (EXCAVATORS) ISUZU ISUZU TIER 3 , 2007		Fuel Filter..... F-5207	
Air Filter Set..... AS-5102-S		Air Filter Primary..... AS-5102		Hydraulic Oil Filter..... H-2712	
ZX330 (EXCAVATORS) ISUZU AA-6HK1XQA , 2002		Air Filter Set..... AS-5102-S		ZX30U (EXCAVATORS) ISUZU 3LD2 (S/N: 05001-UP)	
Air Filter Primary..... AS-5102		ZX350LC-3 (EXCAVATORS) ISUZU AH-6HK1X		Air Filter Primary..... A-8513	
Air Filter Secondary..... A-8651		Cabin Air Filter..... CA-27030		Air Filter Secondary..... A-5569	
Air Filter Set..... AS-5102-S		ZX350LCH (EXCAVATORS) ISUZU AA-6HK1XQA , 2002		Fuel Filter..... F-5207	
Fuel Filter..... FC-1005		Air Filter Primary..... AS-5102		Hydraulic Oil Filter..... H-2712	
Fuel Filter..... FC-2703		Air Filter Set..... AS-5102-S		ZX30U-2 (EXCAVATORS) YANMAR 3TNV88 (S/N: 010001-UP) , 2006	
Hydraulic Oil Filter..... H-2703		ZX350LCH (EXCAVATORS) ISUZU AA-6HK1		Air Filter Primary..... A-8513	
Hydraulic Oil Filter Return..... H-7981		Cabin Air Filter..... CA-27040		Air Filter Secondary..... A-5569	
Hydraulic Oil Filter Suction..... H-2706		ZX350LCH (EXCAVATORS) W/ISUZU AA-6HK1 ENG.		Hydraulic Oil Filter..... H-2712	
ZX330 (EXCAVATORS) ISUZU 6HK1		Cabin Air Filter..... CA-27040		ZX35U-2 (EXCAVATORS) YANMAR 3TNV88 (S/N: 010001-UP)	
Cabin Air Filter..... CA-27040		ZX350LCH (EXCAVATORS) W/ISUZU AA-6HK1XQA , 2002		Air Filter Primary..... A-8513	
ZX330LC (EXCAVATORS) ISUZU AA-6HK1XQA , 2002		Air Filter Primary..... AS-5102		Air Filter Secondary..... A-5569	
Air Filter Primary..... AS-5102		Air Filter Set..... AS-5102-S		Hydraulic Oil Filter..... H-2712	
Air Filter Set..... AS-5102-S		ZX350LCK (EXCAVATORS) ISUZU AA-6HK1XQA , 2002		ZX350L (EXCAVATORS) ISUZU 6HK1	
ZX330LC (EXCAVATORS) ISUZU 6HK1		Air Filter Primary..... AS-5102		Cabin Air Filter..... CA-27050	
Cabin Air Filter..... CA-27040		Air Filter Set..... AS-5102-S		ZX350LCN (EXCAVATORS) ISUZU 6HK1	
ZX350 (EXCAVATORS) ISUZU ISUZU , 2005		ZX350LCK (EXCAVATORS) ISUZU AA-6HK1		Hydraulic Oil Filter Return..... H-27390	
Air Filter Primary..... AS-5102		Cabin Air Filter..... CA-27040			
Air Filter Set..... AS-5102-S		ZX350LCK (EXCAVATORS) W/ISUZU AA-6HK1 ENG.			
ZX350 (EXCAVATORS) ISUZU , 2005		Cabin Air Filter..... CA-27050			
Air Filter Primary..... AS-5102		ZX370 (EXCAVATORS) ISUZU AA-6HK1XQA , 2002			
Air Filter Secondary..... A-8651		Air Filter Primary..... AS-5102			
Air Filter Set..... AS-5102-S					

Sakura Filter

ENGINE APPLICATION

MODEL/APPLICATION	SAKURA NO	MODEL/APPLICATION	SAKURA NO	MODEL/APPLICATION	SAKURA NO
HITACHI		HITACHI		HITACHI	
ZX350LCN (EXCAVATORS) W/ISUZU AA-6HK1 ENG. Cabin Air Filter..... CA-27050		ZX40U-2 (EXCAVATORS) YANMAR 4TNV88 (S/N: 010001-UP) , 2006 Air Filter Primary..... A-8513 Air Filter Secondary..... A-5569 Hydraulic Oil Filter..... H-2712		ZX520LCH-3 (EXCAVATORS) ISUZU AH 6WG1 XYSA-01 (S/N: 020001-UP) , 2006 Air Filter Primary..... A-5629 Air Filter Secondary..... A-5630 Air Filter Set..... A-5629-S Hydraulic Oil Filter..... HC-7901	
ZX450-3 (EXCAVATORS) ISUZU AH 6WG1 XYSA-01/20001 , 2006 Cabin Air Filter..... CA-27020 Cabin Air Filter..... CA-27021		ZX450 (EXCAVATORS) ISUZU 6WG1QA Air Filter Primary..... AS-8579 Air Filter Primary..... AS-8579M Air Filter Secondary..... A-8580 Air Filter Set..... AS-8579-S Fuel Filter..... FC-1005 Fuel Filter..... FC-2703 Hydraulic Oil Filter..... H-2703 Hydraulic Oil Filter..... H-2709 Hydraulic Oil Filter..... HC-7901		ZX50 (EXCAVATORS) KUBOTA V2203 Air Filter Primary..... A-8513 Fuel Filter..... F-5210 Hydraulic Oil Filter..... H-2712	
ZX450-3 (EXCAVATORS) ISUZU AH 6WG1 XYSA-01 (S/N: 020001-UP) , 2006 Air Filter Primary..... A-5629 Air Filter Secondary..... A-5630 Air Filter Set..... A-5629-S Hydraulic Oil Filter..... HC-7901		ZX450 (EXCAVATORS) ISUZU 6WG1T Cabin Air Filter..... CA-27040		ZX500 (EXCAVATORS) Air Filter Primary..... AS-8579 Air Filter Primary..... AS-8579M Air Filter Secondary..... A-8580 Air Filter Set..... AS-8579-S Fuel Filter..... FC-1005 Fuel Filter..... FC-2703 Hydraulic Oil Filter..... H-2703 Hydraulic Oil Filter..... H-2709 Hydraulic Oil Filter..... HC-7901	
ZX450-3 (EXCAVATORS) ISUZU AH-6WG1X Cabin Air Filter..... CA-27030		ZX450LC-3 (EXCAVATORS) ISUZU AH 6WG1 XYSA-01/20001 , 2006 Cabin Air Filter..... CA-27020 Cabin Air Filter..... CA-27021		ZX500 (EXCAVATORS) ISUZU 4LE2 (S/N: 1LE-005001-UP) Air Filter Primary..... A-8513 Air Filter Secondary..... A-5569 Fuel Filter..... F-5207 Hydraulic Oil Filter..... H-2712	
ZX450LC-3 (EXCAVATORS) ISUZU AH-6WG1X Cabin Air Filter..... CA-27030		ZX450LC (EXCAVATORS) ISUZU 6WG1T Cabin Air Filter..... CA-27040		ZX500U-2 (EXCAVATORS) YANMAR 4TNV88 (S/N: 010001-UP) , 2006 Air Filter Primary..... A-8513 Air Filter Secondary..... A-5569 Hydraulic Oil Filter..... H-2712	
ZX470H-3 (EXCAVATORS) ISUZU AH 6WG1 XYSA-01/20001 , 2008 Cabin Air Filter..... CA-27020 Cabin Air Filter..... CA-27021		ZX460LCH (EXCAVATORS) ISUZU 6WG1T Cabin Air Filter..... CA-27050		ZX520-3 (EXCAVATORS) Air Filter Primary..... A-5629 Air Filter Secondary..... A-5630 Air Filter Set..... A-5629-S Hydraulic Oil Filter..... HC-7901	
ZX470H-3 (EXCAVATORS) ISUZU AH-6WG1X Cabin Air Filter..... CA-27030		ZX470-3 (EXCAVATORS) Air Filter Primary..... A-5629 Air Filter Secondary..... A-5630 Air Filter Set..... A-5629-S Hydraulic Oil Filter..... HC-7901		ZX520LC-3 (EXCAVATORS) ISUZU AH-6WG1X Cabin Air Filter..... CA-27030	
ZX470LCH-3 (EXCAVATORS) ISUZU AH 6WG1 XYSA-01/20001 , 2008 Cabin Air Filter..... CA-27020 Cabin Air Filter..... CA-27021		ZX480MT (EXCAVATORS) ISUZU 6WG1T Cabin Air Filter..... CA-27050		ZX500LC-3 (EXCAVATORS) ISUZU AH 6WG1 XYSA-01/20001 , 2006 Cabin Air Filter..... CA-27020 Cabin Air Filter..... CA-27021	
ZX470LCH-3 (EXCAVATORS) ISUZU AH 6WG1 XYSA-01 (S/N: 020001-UP) , 2008 Air Filter Primary..... A-5629 Air Filter Secondary..... A-5630 Air Filter Set..... A-5629-S Hydraulic Oil Filter..... HC-7901		ZX480MTH (EXCAVATORS) ISUZU 6WG1T Cabin Air Filter..... CA-27050		ZX500LC (EXCAVATORS) ISUZU 6WG1T Cabin Air Filter..... CA-27040	
ZX470LCH-3 (EXCAVATORS) ISUZU AH-6WG1X Cabin Air Filter..... CA-27030		ZX500LC-3 (EXCAVATORS) ISUZU AH 6WG1 XYSA-01 (S/N: 020001-UP) , 2006 Air Filter Primary..... A-5629 Air Filter Secondary..... A-5630 Air Filter Set..... A-5629-S Hydraulic Oil Filter..... HC-7901		ZX650LC-3 (EXCAVATORS) ISUZU AH 6WG1 XYSA-02/20001 , 2006 Cabin Air Filter..... CA-27020 Cabin Air Filter..... CA-27021	
ZX40 (EXCAVATORS) KUBOTA V2203 Air Filter Primary..... A-8513 Fuel Filter..... F-5210 Hydraulic Oil Filter..... H-2712		ZX500LC-3 (EXCAVATORS) ISUZU AH-6WG1X Cabin Air Filter..... CA-27030		ZX650LC-3 (EXCAVATORS) ISUZU AH 6WG1 XYSA-02 (S/N: 020001-UP) , 2006 Air Filter Primary..... A-5629 Air Filter Secondary..... A-5630 Air Filter Set..... A-5629-S Hydraulic Oil Filter..... HC-7901	
ZX40U (EXCAVATORS) ISUZU 4LE2 (S/N: 1LD-005001-UP) Air Filter Primary..... A-8513 Air Filter Secondary..... A-5569 Fuel Filter..... F-5207 Hydraulic Oil Filter..... H-2712		ZX520LCH-3 (EXCAVATORS) ISUZU AH 6WG1 XYSA-01/20001 , 2006 Cabin Air Filter..... CA-27020 Cabin Air Filter..... CA-27021			

Sakura Filter

ENGINE APPLICATION

MODEL/APPLICATION	SAKURA NO	MODEL/APPLICATION	SAKURA NO	MODEL/APPLICATION	SAKURA NO
HITACHI		HITACHI		HITACHI	
ZX650LC-3 (EXCAVATORS) ISUZU 6WG1X		Fuel Filter.....	FC-2703	ZX75US (EXCAVATORS) ISUZU 4JG1	
Cabin Air Filter.....	CA-27030	Hydraulic Oil Filter.....	H-2703	Air Filter Primary.....	A-8505
		Hydraulic Oil Filter.....	H-2709	Air Filter Secondary.....	A-8599
ZX670LCH-3 (EXCAVATORS) ISUZU AH 6WG1 XYS-A-02/20001 , 2006				Cabin Air Filter.....	CA-27040
Cabin Air Filter.....	CA-27020	ZX670-3 (EXCAVATORS)		Fuel Filter.....	FC-1801
Cabin Air Filter.....	CA-27021	Air Filter Primary.....	A-5629	Hydraulic Oil Filter.....	H-2703
		Air Filter Secondary.....	A-5630	Oil Filter Full Flow.....	C-1511
ZX670LCH-3 (EXCAVATORS) ISUZU AH 6WG1 XYS-A-02 (S/N: 020001-UP) , 2006		Air Filter Set.....	A-5629-S	Oil Filter Full Flow.....	C-1538
Air Filter Primary.....	A-5629	Hydraulic Oil Filter.....	HC-7901		
Air Filter Secondary.....	A-5630			ZX850LC-3 (EXCAVATORS) ISUZU AH 6WG1 XYS-A-03/20001 , 2006	
Air Filter Set.....	A-5629-S	ZX60-5G (EXCAVATORS) 4TNV98-07559		Air Filter Primary.....	AS-5102
Hydraulic Oil Filter.....	HC-7901	Air Filter Primary.....	AS-27170	Air Filter Set.....	AS-5102-S
		Air Filter Set.....	AS-27170-S	Cabin Air Filter.....	CA-27020
ZX670LCH-3 (EXCAVATORS) ISUZU 6WG1X		ZX65USB-5A (EXCAVATORS) 4TNV94L-ZWHB , 3000, 2015		Cabin Air Filter.....	CA-27021
Cabin Air Filter.....	CA-27030	Air Filter Secondary.....	A-27180		
		ZX70 (EXCAVATORS) ISUZU AA-4JG1		ZX850LC-3 (EXCAVATORS) ISUZU AH 6WG1 XYS-A-03 (S/N: 020001-UP) , 2006	
ZX600 (EXCAVATORS) ISUZU 6WG1		Cabin Air Filter.....	CA-27040	Air Filter Primary.....	AS-5102
Air Filter Primary.....	AS-8579			Air Filter Secondary.....	A-8651
Air Filter Primary.....	AS-8579M	ZX70 (EXCAVATORS)		Air Filter Set.....	AS-5102-S
Air Filter Secondary.....	A-8580	Air Filter Primary.....	A-8505	Hydraulic Oil Filter.....	HC-7901
Air Filter Set.....	AS-8579-S	Air Filter Secondary.....	A-8599		
Fuel Filter.....	FC-1005	Fuel Filter.....	FC-1801	ZX850LC-3 (EXCAVATORS) ISUZU 6WG1X	
Fuel Filter.....	FC-2703	Hydraulic Oil Filter.....	H-2703	Cabin Air Filter.....	CA-27030
Hydraulic Oil Filter.....	H-2703	Hydraulic Oil Filter.....	H-2709		
Hydraulic Oil Filter.....	H-2709	Oil Filter Full Flow.....	C-1511	ZX870LCH-3 (EXCAVATORS) ISUZU AH 6WG1 XYS-A-03/20001 , 2006	
Hydraulic Oil Filter.....	HC-7901	Oil Filter Full Flow.....	C-1538	Air Filter Primary.....	AS-5102
				Air Filter Set.....	AS-5102-S
ZX650 (EXCAVATORS)		ZX70LC (EXCAVATORS) ISUZU AA-4JG1		Cabin Air Filter.....	CA-27020
Air Filter Primary.....	AS-8579	Air Filter Primary.....	A-8505	Cabin Air Filter.....	CA-27021
Air Filter Primary.....	AS-8579M	Air Filter Secondary.....	A-8599		
Air Filter Secondary.....	A-8580	Cabin Air Filter.....	CA-27040	ZX870LCH-3 (EXCAVATORS) ISUZU AH 6WG1 XYS-A-03 (S/N: 020001-UP) , 2006	
Air Filter Set.....	AS-8579-S	Fuel Filter.....	FC-1005	Air Filter Primary.....	AS-5102
Fuel Filter.....	FC-1005	Fuel Filter.....	FC-1801	Air Filter Secondary.....	A-8651
Fuel Filter.....	FC-2703	Hydraulic Oil Filter.....	H-2703	Air Filter Set.....	AS-5102-S
Hydraulic Oil Filter.....	H-2703	Hydraulic Oil Filter.....	H-2709	Hydraulic Oil Filter.....	HC-7901
Hydraulic Oil Filter.....	H-2709	Oil Filter Full Flow.....	C-1511		
Hydraulic Oil Filter.....	HC-7901	Oil Filter Full Flow.....	C-1538	ZX870LCH-3 (EXCAVATORS) ISUZU 6WG1X	
				Cabin Air Filter.....	CA-27030
ZX650-3 (EXCAVATORS) ISUZU 6WG1X		ZX75UR (EXCAVATORS) ISUZU 4JG1			
Cabin Air Filter.....	CA-27030	Fuel Filter.....	FC-1824	ZX80 (EXCAVATORS) ISUZU AA-4JG1	
				Air Filter Primary.....	A-8505
ZX650H (EXCAVATORS) ISUZU 6WG1 XQA01		ZX75UR (EXCAVATORS) ISUZU CC-4JG1 (S/N: 040001-UP)		Air Filter Secondary.....	A-8599
Air Filter Primary.....	AS-8579	Air Filter Primary.....	A-8505	Fuel Filter.....	FC-1005
Air Filter Primary.....	AS-8579M	Air Filter Secondary.....	A-8599	Fuel Filter.....	FC-1801
Air Filter Secondary.....	A-8580	Fuel Filter.....	FC-1801	Hydraulic Oil Filter.....	H-2703
Air Filter Set.....	AS-8579-S	Hydraulic Oil Filter.....	H-2703	Hydraulic Oil Filter.....	H-2709
Fuel Filter.....	FC-2703	Oil Filter Full Flow.....	C-1511	Oil Filter Full Flow.....	C-1511
Hydraulic Oil Filter.....	H-2703	Oil Filter Full Flow.....	C-1538	Oil Filter Full Flow.....	C-1538
Hydraulic Oil Filter.....	H-2709				
Hydraulic Oil Filter.....	HC-7901	ZX75US (EXCAVATORS) 2008		ZX80 (EXCAVATORS) ISUZU CC-4JG1	
		Air Filter Primary.....	A-8505	Cabin Air Filter.....	CA-27040
ZX650LCH (EXCAVATORS) ISUZU BB6WG , 2001		Air Filter Secondary.....	A-8599		
Air Filter Primary.....	AS-8579	Fuel Filter.....	FC-1005	ZX805B (EXCAVATORS) ISUZU AA-4JG1	
Air Filter Primary.....	AS-8579M	Fuel Filter.....	FC-1801	Air Filter Primary.....	A-8505
Air Filter Secondary.....	A-8580	Hydraulic Oil Filter.....	H-2703	Air Filter Secondary.....	A-8599
Air Filter Set.....	AS-8579-S	Hydraulic Oil Filter.....	H-2709	Fuel Filter.....	FC-1005
Fuel Filter.....	FC-2703	Oil Filter Full Flow.....	C-1511	Fuel Filter.....	FC-1801
Hydraulic Oil Filter.....	H-2703	Oil Filter Full Flow.....	C-1538		
Hydraulic Oil Filter.....	H-2709				
Hydraulic Oil Filter.....	HC-7901				

MODEL/APPLICATION	SAKURA NO
HITACHI	
ZX805B (EXCAVATORS) ISUZU AA-4JG1	
Hydraulic Oil Filter.....	H-2703
Oil Filter Full Flow.....	C-1511
Oil Filter Full Flow.....	C-1538
ZX8-2 (EXCAVATORS) YANMAR 3TNV70 , 2008	
Hydraulic Oil Filter.....	H-2712
ZX850 (EXCAVATORS) ISUZU 6WG1	
Air Filter Primary.....	A-5629
Air Filter Secondary.....	A-5630
Air Filter Set.....	A-5629-S
Cabin Air Filter.....	CA-27040
Fuel Filter.....	FC-1005
Fuel Filter.....	FC-2703
Hydraulic Oil Filter.....	H-2703
Hydraulic Oil Filter.....	HC-7901
ZX850H (EXCAVATORS)	
Air Filter Secondary.....	A-5630
Fuel Filter.....	FC-2703
ZX85US (EXCAVATORS) ISUZU 4JG1	
Air Filter Primary.....	A-8505
Air Filter Secondary.....	A-8599
Cabin Air Filter.....	CA-27040
Fuel Filter.....	FC-1005
Fuel Filter.....	FC-1801
Hydraulic Oil Filter.....	H-2703
Oil Filter Full Flow.....	C-1511
Oil Filter Full Flow.....	C-1538
ZX870-3 (EXCAVATORS) 2006	
Air Filter Primary.....	AS-5102
Air Filter Secondary.....	A-8651
Air Filter Set.....	AS-5102-S
Hydraulic Oil Filter.....	HC-7901
ZX870H-3 (EXCAVATORS) ISUZU 6WG1X	
Cabin Air Filter.....	CA-27030
ZX85USB-5A (EXCAVATORS) 4TNV94L , 3000, 2015	
Air Filter Secondary.....	A-27180
ZX850-3 (EXCAVATORS) ISUZU 6WG1X	
Cabin Air Filter.....	CA-27030
ZZ270LC (EXCAVATORS) ISUZU 6BG1	
Fuel Filter.....	FC-15031

B

A-1013 Air Filter Primary Metal End Cap Element



ISUZU 1-14214126-0
ISUZU 1-14215-181-0
ISUZU 1-86750-309-0
NISSAN 16546-96071
NISSAN 16546-99218
Secondary Filter uses A-5631
Set Filter uses A-1841-S
H 1 : 394.7 (mm)
H 2 : 382 (mm)
OD 1 : 276 (mm)
OD 2 : 275 (mm)
ID 1 : 165 (mm)
ID 2 : 23 (mm)

CONT : 4
VOL : 0.154

Note : Is a Primary Air Filter for A-5631,A-7607

A-1841-S Air Filter Set Metal End Cap Element



NISSAN 16546-96070
HITACHI 4288963+4288964
KOMATSU 600-181-1600

Primary Filter uses A-1013
Secondary Filter uses A-5631
H 1 : 395 (mm)
H 2 : 382 (mm)
OD 1 : 276 (mm)
OD 2 : 276 (mm)
ID 1 : 165 (mm)
ID 2 : 23 (mm)

CONT : 4
VOL : 0.163

A-2703-S Air Filter Set Metal End Cap Element



HITACHI 4206099+4247975

Primary Filter uses A-2703
Secondary Filter uses A-2704
H 1 : 317.7 (mm)
H 2 : 305 (mm)
OD 1 : 155 (mm)
OD 2 : 155 (mm)
ID 1 : 104 (mm)
ID 2 : 17 (mm)

CONT : 9
VOL : 0.123

A-10134 Air Filter Primary Metal End Cap Element



MITSUBISHI ME 063130

H 1 : 394.7 (mm)
H 2 : 382 (mm)
OD 1 : 276 (mm)
OD 2 : 275 (mm)
ID 1 : 165 (mm)
ID 2 : 23 (mm)

CONT : 1
VOL : 0.035

Note : Flame retardant version from A-1013

A-2210 Air Filter Primary Metal End Cap Element



FIAT 0068473-3
ISUZU 1-14215-018-0
ISUZU 1-14215007-0
NISSAN 16546-96011

Secondary Filter uses A-6008
Set Filter uses A-6117-S
H 1 : 342.7 (mm)
H 2 : 330 (mm)
OD 1 : 234 (mm)
OD 2 : 234 (mm)
ID 1 : 123 (mm)
ID 2 : 17 (mm)

CONT : 4
VOL : 0.093

A-2704 Air Filter Secondary Metal End Cap Element



HITACHI 4247975

Primary Filter uses A-2702

H 1 : 294.7 (mm)
H 2 : 285 (mm)
OD 1 : 100.5 (mm)
OD 2 : 100.5 (mm)
ID 1 : 81 (mm)
ID 2 : 17 (mm)

CONT : 25
VOL : 0.099

Note : Is a Secondary Air filter for A-2704,A-2702

A-1307 Air Filter Secondary Metal End Cap Element



ISUZU 1-14215085-0
HINO 17801-2460
CATERPILLAR 3I-0179

Primary Filter uses A-1313
Set Filter uses A-5662-S
H 1 : 444.7 (mm)
H 2 : 432 (mm)
OD 1 : 145 (mm)
OD 2 : 145 (mm)
ID 1 : 116.5 (mm)
ID 2 : 23 (mm)

CONT : 9
VOL : 0.106

A-2702 Air Filter Primary Metal End Cap Element



HITACHI 4285623

Secondary Filter uses A-2704
Set Filter uses A-2702-S
H 1 : 327.2 (mm)
H 2 : 317.7 (mm)
OD 1 : 200 (mm)
OD 2 : 155 (mm)
ID 1 : 104 (mm)
ID 2 : 17 (mm)

CONT : 9
VOL : 0.159

A-2705 Air Filter Secondary Soft PU end cap Element



HITACHI 4287060
KOBELCO YN02P000013B

Primary Filter uses A-2706
Set Filter uses A-2707-S
H 1 : 353 (mm)
H 2 : 347 (mm)
OD 1 : 124 (mm)
OD 2 : 117 (mm)
ID 1 : 104 (mm)

CONT : 25
VOL : 0.178

A-13092-S Air Filter Set Metal End Cap Element



HINO 17801-2490+17801-3050

Primary Filter uses A-1309
Secondary Filter uses A-13550
H 1 : 493 (mm)
H 2 : 480 (mm)
OD 1 : 307 (mm)
OD 2 : 307 (mm)
ID 1 : 196 (mm)
ID 2 : 23 (mm)

CONT : 1
VOL : 0.054

A-2702-S Air Filter Set Metal End Cap Element



HITACHI 4285623+4247975

Primary Filter uses A-2702
Secondary Filter uses A-2704
H 1 : 327.2 (mm)
H 2 : 317.5 (mm)
OD 1 : 200 (mm)
OD 2 : 155 (mm)
ID 1 : 104 (mm)
ID 2 : 17 (mm)

CONT : 9
VOL : 0.159

A-2706 Air Filter Primary Soft PU end cap Element



HITACHI 4283861
KOBELCO YN02P000013A

Secondary Filter uses A-2705
Set Filter uses A-2707-S
H 1 : 367.5 (mm)
H 2 : 355.5 (mm)
OD 1 : 207 (mm)
OD 2 : 208 (mm)
ID 1 : 123 (mm)

CONT : 9
VOL : 0.175

A-1313 Air Filter Primary Metal End Cap Element



CATERPILLAR 099-5801
ISUZU 1-14215084-0
HINO 17720-3640
HINO 17801-2530

Secondary Filter uses A-1307
Set Filter uses A-5662-S
H 1 : 469.75 (mm)
H 2 : 457 (mm)
OD 1 : 232 (mm)
OD 2 : 232 (mm)
ID 1 : 147 (mm)
ID 2 : 23 (mm)

CONT : 4
VOL : 0.123

A-2703 Air Filter Primary Metal End Cap Element



HITACHI 4206099

Secondary Filter uses A-2704
Set Filter uses A-2703-S
H 1 : 317.7 (mm)
H 2 : 305 (mm)
OD 1 : 155 (mm)
OD 2 : 155 (mm)
ID 1 : 104 (mm)
ID 2 : 17 (mm)

CONT : 9
VOL : 0.123

A-2708 Air Filter Primary Metal End Cap Element



HITACHI 4206098
HITACHI 4285619
HITACHI 4484532

Secondary Filter uses A-7956
Set Filter uses A-2711-S
H 1 : 275.7 (mm)
H 2 : 263 (mm)
OD 1 : 201.5 (mm)
OD 2 : 252 (mm)
ID 1 : 135.5 (mm)
ID 2 : 22 (mm)

CONT : 1
VOL : 0.022

Sakura Filter

Technical Specification

A-2709-S Air Filter Set Soft PU end cap Element
 HITACHI 4286128+4286130

Primary Filter uses A-5539
 Secondary Filter uses A-5538
 H 1 : 370 (mm)
 H 2 : 357 (mm)
 OD 1 : 237 (mm)
 OD 2 : 237 (mm)
 ID 1 : 132 (mm)

CONT : 4
 VOL : 0.107

Note : with metal reinforcement version A-2709M-S

A-28710 Air Filter Primary Metal End Cap Element
 HYUNDAI 11N8-22140



Secondary Filter uses A-28720
 Set Filter uses A-28730-S
 H 1 : 502.75 (mm)
 H 2 : 490 (mm)
 OD 1 : 276 (mm)
 OD 2 : 275 (mm)
 ID 1 : 165 (mm)
 ID 2 : 19 (mm)

CONT : 1
 VOL : 0.047

A-5539 Air Filter Primary Soft PU end cap Element
 HITACHI 4286128
 ISUZU 8-98071421-0



Secondary Filter uses A-5538
 Set Filter uses A-2709-S
 H 1 : 370 (mm)
 H 2 : 357 (mm)
 OD 1 : 237 (mm)
 OD 2 : 237 (mm)
 ID 1 : 132 (mm)

CONT : 1
 VOL : 0.024

Note : A-5539M (Reinforcement Difference)

A-2709M-S Air Filter Set Soft PU+Metal Element
 HITACHI 4286128+4286130



Primary Filter uses A-5539M
 Secondary Filter uses A-5538
 H 1 : 370 (mm)
 H 2 : 357 (mm)
 OD 1 : 237 (mm)
 OD 2 : 237 (mm)
 ID 1 : 130 (mm)

CONT : 4
 VOL : 0.107

Note : Soft Pu only uses A-2709-S

A-28730-S Air Filter Set Metal End Cap Element
 HYUNDAI 11N8-22140+11N8-22150



Primary Filter uses A-28710
 Secondary Filter uses A-28720
 H 1 : 502.75 (mm)
 H 2 : 490 (mm)
 OD 1 : 276 (mm)
 OD 2 : 275 (mm)
 ID 1 : 134 (mm)
 ID 2 : 19 (mm)

CONT : 1
 VOL : 0.047

A-5539M Air Filter Primary Soft PU+Metal Element with metal reinforcement
 HITACHI 4286128
 ISUZU 8-98071421-0



Secondary Filter uses A-5538
 Set Filter uses A-2709M-S
 H 1 : 370 (mm)
 H 2 : 357 (mm)
 OD 1 : 237 (mm)
 OD 2 : 237 (mm)
 ID 1 : 132 (mm)

CONT : 1
 VOL : 0.024

A-2711-S Air Filter Set Metal End Cap Element
 HITACHI 4206098+4247974



Primary Filter uses A-2708
 Secondary Filter uses A-7956
 H 1 : 275.7 (mm)
 H 2 : 263 (mm)
 OD 1 : 201.5 (mm)
 OD 2 : 252 (mm)
 ID 1 : 135.5 (mm)
 ID 2 : 22 (mm)

CONT : 1
 VOL : 0.021

A-5301 Air Filter Primary Metal End Cap Element
 ATLAS COPCO 1619-27-98-00
 DEUTZ 2165041
 DEUTZ 2165054



Secondary Filter uses A-6210
 Set Filter uses A-5301-S
 H 1 : 383.7 (mm)
 H 2 : 371 (mm)
 OD 1 : 228 (mm)
 OD 2 : 228 (mm)
 ID 1 : 117 (mm)
 ID 2 : 11 (mm)

CONT : 1
 VOL : 0.023

A-5540 Air Filter Secondary Soft PU end cap Element
 YANMAR 119117-12570
 CATERPILLAR 1318903
 PERKINS 26510343
 YANMAR Y119117-12570



Primary Filter uses A-5541
 Set Filter uses A-5541-S
 H 1 : 346 (mm)
 H 2 : 340 (mm)
 OD 1 : 92 (mm)
 OD 2 : 86.5 (mm)
 ID 1 : 72.5 (mm)

CONT : 25
 VOL : 0.105

A-2715 Air Filter Metal framed Element
 HITACHI 4206637
 HITACHI 4S01130
 JOHN DEERE AT116077



H 1 : 55.6 (mm)
 Length 1 : 435 (mm)
 Width 1 : 215 (mm)

CONT : 1
 VOL : 0.009

A-5408 Air Filter Secondary Metal End Cap Element
 ISUZU 1-14215034-0
 ISUZU 1-14215036-0
 NISSAN 16546-96014



Primary Filter uses A-6113
 Set Filter uses A-5653-S
 H 1 : 406 (mm)
 OD 1 : 192.3 (mm)
 OD 2 : 162.5 (mm)
 ID 1 : 134.2 (mm)
 ID 2 : 17 (mm)

CONT : 9
 VOL : 0.167

Note : Is a Secondary Air filter for A-6113,A-54490

A-5541 Air Filter Primary Soft PU end cap Element
 YANMAR 119117-12560
 CATERPILLAR 131-8902
 PERKINS 26510342
 LIUGONG 40C0496
 HITACHI 4486002



Secondary Filter uses A-5540
 Set Filter uses A-5541-S
 H 1 : 356 (mm)
 H 2 : 347 (mm)
 OD 1 : 163.5 (mm)
 OD 2 : 163.5 (mm)
 ID 1 : 91 (mm)

CONT : 9
 VOL : 0.108

A-27180 Air Filter Secondary Plastic Element
 IHI 074526509
 YANMAR 172B06-11520



Primary Filter uses AS-27170
 Set Filter uses AS-27170-S
 H 1 : 272 (mm)
 OD 1 : 72.4 (mm)
 OD 2 : 71 (mm)
 ID 1 : 63 (mm)

CONT : 25
 VOL : 0.044

A-5538 Air Filter Secondary Soft PU end cap Element
 HITACHI 4286130



Primary Filter uses A-5539
 Set Filter uses A-2709-S
 H 1 : 353 (mm)
 H 2 : 347 (mm)
 OD 1 : 133 (mm)
 OD 2 : 125 (mm)
 ID 1 : 110 (mm)

CONT : 9
 VOL : 0.075

Note : Is a Secondary Air filter for A-5539,A-5539M

A-5541M Air Filter Primary Soft PU+Metal Element
 CATERPILLAR 131-8902
 LIUGONG 40C0496



Secondary Filter uses A-5540
 Set Filter uses A-5541M-S
 H 1 : 356 (mm)
 H 2 : 347 (mm)
 OD 1 : 163.5 (mm)
 OD 2 : 163.5 (mm)
 ID 1 : 91 (mm)

CONT : 9
 VOL : 0.108

A-5541M-S Air Filter Set Soft PU+Metal Element

CATERPILLAR 131-8902+131-8903
LIUGONG 40C0496



Primary Filter uses A-5541M
Secondary Filter uses A-5540
H 1 : 353 (mm)
H 2 : 344 (mm)
OD 1 : 163.5 (mm)
OD 2 : 163.5 (mm)
ID 1 : 91 (mm)

CONT : 9
VOL : 0.116

31

A-5628 Air Filter Primary Metal End Cap Element

CHRYSLER 3614353
KOMATSU 600-181-8240



Secondary Filter uses A-7611
Set Filter uses A-5628-S
H 1 : 311 (mm)
H 2 : 305 (mm)
OD 1 : 155 (mm)
OD 2 : 155 (mm)
ID 1 : 88 (mm)
ID 2 : 17 (mm)

CONT : 12
VOL : 0.120

36

A-5631 Air Filter Secondary Metal End Cap Element

ISUZU 1-14215087-0
NISSAN 16546-96072
HITACHI 4288964



Primary Filter uses A-1013
Set Filter uses A-1841-S
H 1 : 361.75 (mm)
H 2 : 349 (mm)
OD 1 : 162.5 (mm)
OD 2 : 163 (mm)
ID 1 : 134 (mm)
ID 2 : 17 (mm)

CONT : 9
VOL : 0.110

41

A-5569 Air Filter Secondary Soft PU end cap Element

VOLVO 11801160
CATERPILLAR 1467473
LIUGONG 40C0445
JOHN DEERE M131803
KOMATSU YM12905112530



Primary Filter uses A-8513
Set Filter uses A-5570-S
H 1 : 265 (mm)
H 2 : 259 (mm)
OD 1 : 61 (mm)
OD 2 : 59 (mm)
ID 1 : 45 (mm)

CONT : 25
VOL : 0.048

32

A-5628-S Air Filter Set Metal End Cap Element

CLAAS 3200010+3200020
BLOUNT 537986+537987
BOBCAT 6681474+6681475
JOHN DEERE AT44377+AT44378



Primary Filter uses A-5628
Secondary Filter uses A-7611
H 1 : 311 (mm)
H 2 : 305 (mm)
OD 1 : 155 (mm)
OD 2 : 155 (mm)
ID 1 : 88 (mm)
ID 2 : 17 (mm)

CONT : 4
VOL : 0.047

37

A-5662-S Air Filter Set Metal End Cap Element

KOMATSU 600-181-8600
KOMATSU 600-182-2700
KOMATSU 600-182-3200



Primary Filter uses A-1313
Secondary Filter uses A-1307
H 1 : 457 (mm)
H 2 : 432 (mm)
OD 1 : 232 (mm)
OD 2 : 145 (mm)
ID 1 : 147 (mm)
ID 2 : 23 (mm)

CONT : 4
VOL : 0.123

42

A-5610 Air Filter Secondary Metal End Cap Element

NISSAN 16546-97005
CATERPILLAR 3I-0125
HITACHI 4177212



Primary Filter uses A-5614
Set Filter uses A-5613-S
H 1 : 449 (mm)
OD 1 : 214.8 (mm)
OD 2 : 185 (mm)
ID 1 : 157.5 (mm)
ID 2 : 17 (mm)

CONT : 4
VOL : 0.099

Note : Is a Secondary Air filter for A-5614,A-5618

33

A-5629 Air Filter Primary Metal End Cap Element

ISUZU 1-14125082-0
ISUZU 1-14215082-0
CATERPILLAR 3I-0202



Secondary Filter uses A-5630
Set Filter uses A-5629-S
H 1 : 622 (mm)
H 2 : 609.5 (mm)
OD 1 : 307 (mm)
OD 2 : 307 (mm)
ID 1 : 196 (mm)
ID 2 : 22.7 (mm)

CONT : 1
VOL : 0.071

38

A-5663-S Air Filter Set Metal End Cap Element

KOMATSU 600-181-6050



Primary Filter uses A-5627
Secondary Filter uses A-6008
H 1 : 380 (mm)
H 2 : 330 (mm)
OD 1 : 235 (mm)
OD 2 : 187 (mm)
ID 1 : 120 (mm)
ID 2 : 17 (mm)

CONT : 1
VOL : 0.030

43

A-5614 Air Filter Primary Metal End Cap Element

CATERPILLAR 3I-0374
KOMATSU 600-181-4400
KOMATSU 600-181-4400P



Secondary Filter uses A-5610
Set Filter uses A-5613-S
H 1 : 469.75 (mm)
H 2 : 457 (mm)
OD 1 : 307 (mm)
OD 2 : 377 (mm)
ID 1 : 196 (mm)
ID 2 : 24 (mm)

CONT : 1
VOL : 0.073

34

A-5629-S Air Filter Set Metal End Cap Element

HITACHI 4240294+4240295
KOMATSU
561-02-12330+561-02-12320



Primary Filter uses A-5629
Secondary Filter uses A-5630
H 1 : 622 (mm)
H 2 : 609.5 (mm)
OD 1 : 307 (mm)
OD 2 : 307 (mm)
ID 1 : 196 (mm)
ID 2 : 22.7 (mm)

CONT : 1
VOL : 0.071

39

A-5708 Air Filter Metal End Cap Element

CUMMINS 158877



H 1 : 266.75 (mm)
H 2 : 254 (mm)
OD 1 : 234 (mm)
OD 2 : 234 (mm)
ID 1 : 123 (mm)
ID 2 : 14 (mm)

CONT : 4
VOL : 0.072

44

A-5627 Air Filter Primary Metal End Cap Element

KOBELCO 2451-U311-3
DAEWOO 2474-6006A
DAEWOO 2474-6006B



Secondary Filter uses A-6008
Set Filter uses A-5663-S
H 1 : 393.7 (mm)
H 2 : 381 (mm)
OD 1 : 235 (mm)
OD 2 : 187 (mm)
ID 1 : 120 (mm)
ID 2 : 17 (mm)

CONT : 1
VOL : 0.026

35

A-5630 Air Filter Secondary Metal End Cap Element

ISUZU 1-14215081-0
CATERPILLAR 3I-0203
HITACHI 4240295



Primary Filter uses A-5629
Set Filter uses A-5629-S
H 1 : 596.7 (mm)
H 2 : 584 (mm)
OD 1 : 185 (mm)
OD 2 : 185 (mm)
ID 1 : 157.5 (mm)
ID 2 : 17 (mm)

CONT : 1
VOL : 0.025

40

A-5715 Air Filter Secondary Metal End Cap Element

CATERPILLAR 1N-4864
CUMMINS 3013213
CATERPILLAR 3I-0215



Primary Filter uses A-5718
Set Filter uses A-5718-S
H 1 : 571.75 (mm)
H 2 : 559 (mm)
OD 1 : 260 (mm)
OD 2 : 260 (mm)
ID 1 : 231.5 (mm)
ID 2 : 23 (mm)

CONT : 1
VOL : 0.047

45

Sakura Filter

Technical Specification

A-5718 Air Filter Primary Metal End Cap Element

CUMMINS 3013212
CATERPILLAR 3I-0795
HITACHI 4206272



Secondary Filter uses A-5715
Set Filter uses A-5718-S
H 1 : 622.7 (mm)
H 2 : 610 (mm)
OD 1 : 373 (mm)
OD 2 : 373 (mm)
ID 1 : 262.5 (mm)
ID 2 : 23 (mm)

CONT : 1
VOL : 0.102

46

A-6011 Air Filter Secondary Metal End Cap Element

ISUZU 1-14215118-0
ISUZU 1-14215127-0
ISUZU 14215-127



Primary Filter uses A-6010
Set Filter uses A-6010-S
H 1 : 469.7 (mm)
H 2 : 457 (mm)
OD 1 : 185 (mm)
OD 2 : 185 (mm)
ID 1 : 157.5 (mm)
ID 2 : 17 (mm)

CONT : 9
VOL : 0.190

51

A-7119-S Air Filter Set Soft PU end cap Element

VOLVO 11033998+11033999
VOLVO 110339983+110033991
TEREX 15272252+15272253



Primary Filter uses A-7118
Secondary Filter uses A-7117
H 1 : 580 (mm)
H 2 : 569 (mm)
OD 1 : 313 (mm)
OD 2 : 313 (mm)
ID 1 : 178 (mm)

CONT : 1
VOL : 0.064

56

A-6006 Air Filter Primary Metal End Cap Element

ISUZU 1-14214108-0
ISUZU 1-14214153-0
ISUZU 1-14215060-0
NISSAN 16546-Z9010
TOYOTA 17801-2560



Secondary Filter uses A-6007
Set Filter uses A-6118-S
H 1 : 342.7 (mm)
H 2 : 330 (mm)
OD 1 : 232 (mm)
OD 2 : 232 (mm)
ID 1 : 147 (mm)
ID 2 : 23 (mm)

CONT : 4
VOL : 0.093

Note : For Flame Retardant version use A-60400

47

A-6113 Air Filter Primary Metal End Cap Element

FIAT 01901779
ISUZU 1-14215046-0
NISSAN 16546-96017



Secondary Filter uses A-5408
Set Filter uses A-5653-S
H 1 : 418.7 (mm)
H 2 : 406 (mm)
OD 1 : 282 (mm)
OD 2 : 282 (mm)
ID 1 : 171 (mm)
ID 2 : 17 (mm)

CONT : 1
VOL : 0.038

52

A-7605 Air Filter Secondary Metal End Cap Element

CASE 537335R1
FIAT 79022026
JOHN DEERE AL27159



Primary Filter uses AS-7609
Set Filter uses AS-7609-S
H 1 : 280.7 (mm)
H 2 : 279.4 (mm)
OD 1 : 92.5 (mm)
OD 2 : 75 (mm)
ID 1 : 61 (mm)
ID 2 : 17 (mm)

CONT : 25
VOL : 0.089

57

A-6007 Air Filter Secondary Metal End Cap Element

ISUZU 1-14215061-0
ISUZU 1-14215078-0
ISUZU 1-14215078-1



Primary Filter uses A-6006
Set Filter uses A-6118-S
H 1 : 317.7 (mm)
H 2 : 305 (mm)
OD 1 : 145 (mm)
OD 2 : 145 (mm)
ID 1 : 116.5 (mm)
ID 2 : 23 (mm)

CONT : 9
VOL : 0.078

Note : ID=17 MM uses A-6031

48

A-6118-S Air Filter Set Metal End Cap Element

NISSAN 16546-Z9025
NISSAN 16546-Z9027
CATERPILLAR 7Y-0404+7Y-0403



Primary Filter uses A-6006
Secondary Filter uses A-6007
H 1 : 343 (mm)
H 2 : 330 (mm)
OD 1 : 232 (mm)
OD 2 : 232 (mm)
ID 1 : 147 (mm)
ID 2 : 23 (mm)

CONT : 4
VOL : 0.097

53

A-7619 Air Filter Secondary Metal End Cap Element

MASSEY-FERGUSON 3580724M1
LIEBHERR 7403951
JOHN DEERE RE42762



Primary Filter uses AS-7621
Set Filter uses AS-7622-S
H 1 : 393.7 (mm)
H 2 : 381 (mm)
OD 1 : 151 (mm)
OD 2 : 151 (mm)
ID 1 : 123 (mm)
ID 2 : 17 (mm)

CONT : 9
VOL : 0.120

58

A-6008 Air Filter Secondary Metal End Cap Element

ISUZU 1-14215047-0
ISUZU 1-1425-046-1
NISSAN 16546-96010



Primary Filter uses A-5627
Set Filter uses A-5663-S
H 1 : 330 (mm)
OD 1 : 146 (mm)
OD 2 : 116.5 (mm)
ID 1 : 88 (mm)
ID 2 : 17 (mm)

CONT : 9
VOL : 0.083

49

A-7117 Air Filter Secondary Soft PU end cap Element

VOLVO CONSTRUCTION EQUIPMENT 11033999
VOLVO CONSTRUCTION EQUIPMENT 11033999-1



Primary Filter uses A-7118
Set Filter uses A-7119-S
H 1 : 563 (mm)
H 2 : 557 (mm)
OD 1 : 179 (mm)
OD 2 : 179 (mm)
ID 1 : 148 (mm)

CONT : 6
VOL : 0.133

54

A-76231 Air Filter Primary Soft PU end cap Element flame retardant media

CLARK 1241080
TOYOTA 17741-U3330-71
KOMATSU 3EC02A541E
LIUGONG 40C0496



H 1 : 356 (mm)
H 2 : 347 (mm)
OD 1 : 163.5 (mm)
OD 2 : 163.5 (mm)
ID 1 : 91 (mm)

CONT : 9
VOL : 0.116

Note : Flame Retardant version of A-5541

59

A-6010 Air Filter Primary Metal End Cap Element

ISUZU 1-14215116-0
ISUZU 1-14215117-0
ISUZU 1-14215128-0



Secondary Filter uses A-6011
Set Filter uses A-6010-S
H 1 : 495.7 (mm)
H 2 : 483 (mm)
OD 1 : 307 (mm)
OD 2 : 307 (mm)
ID 1 : 196 (mm)
ID 2 : 23 (mm)

CONT : 1
VOL : 0.060

50

A-7118 Air Filter Primary Soft PU end cap Element

VOLVO CONSTRUCTION EQUIPMENT 11033998
VOLVO CONSTRUCTION EQUIPMENT 11033998-3



Secondary Filter uses A-7117
Set Filter uses A-7119-S
H 1 : 580 (mm)
H 2 : 569 (mm)
OD 1 : 313 (mm)
OD 2 : 313 (mm)
ID 1 : 178 (mm)

CONT : 1
VOL : 0.068

55

A-76660 Air Filter Secondary Metal End Cap Element

HITACHI AR80653
JOHN DEERE AR80653
JOHN DEERE SR80653



Primary Filter uses A-76670
Set Filter uses A-76670-S
H 1 : 411 (mm)
H 2 : 398 (mm)
OD 1 : 131 (mm)
OD 2 : 131 (mm)
ID 1 : 102 (mm)
ID 2 : 16.5 (mm)

CONT : 9
VOL : 0.091

60

Sakura Filter

Technical Specification

A-76670 Air Filter Primary Metal End Cap Element

JOHN DEERE AR76766
HITACHI AR80652
JOHN DEERE AR80652



Secondary Filter uses A-76660
Set Filter uses A-76670-S
H 1 : 503 (mm)
H 2 : 493 (mm)
OD 1 : 231 (mm)
OD 2 : 231 (mm)
ID 1 : 133 (mm)
ID 2 : 10 (mm)

CONT : 4
VOL : 0.135

61

A-7915 Air Filter Secondary Metal End Cap Element

CATERPILLAR 1N-8164
CATERPILLAR 4N-9164
INGERSOLL RAND 50616408



Primary Filter uses A-7912
Set Filter uses A-7912-S
H 1 : 432.7 (mm)
H 2 : 423 (mm)
OD 1 : 220 (mm)
OD 2 : 220 (mm)
ID 1 : 179 (mm)
ID 2 : 23 (mm)

CONT : 4
VOL : 0.104

66

A-8505 Air Filter Primary Soft PU end cap Element

OPEL 1#123 84 075
OPEL 1-12384075
SUNWARD 730403000155



Secondary Filter uses A-8599
Set Filter uses A-8602-S
H 1 : 312 (mm)
H 2 : 304 (mm)
OD 1 : 127.5 (mm)
OD 2 : 127.5 (mm)
ID 1 : 83 (mm)

CONT : 16
VOL : 0.109

Note : For Flame Retardant version, use A-76410

71

A-76670-S Air Filter Set Metal End Cap Element

JOHN DEERE AR80652+AR80653



Primary Filter uses A-76670
Secondary Filter uses A-76660
H 1 : 503 (mm)
H 2 : 493 (mm)
OD 1 : 231 (mm)
OD 2 : 231 (mm)
ID 1 : 102 (mm)
ID 2 : 10 (mm)

CONT : 4
VOL : 0.135

62

A-7954 Air Filter Primary Metal End Cap Element

ATLAS COPCO 3216-7082-01



Secondary Filter uses A-7809
Set Filter uses A-7954-S
H 1 : 419.7 (mm)
H 2 : 407 (mm)
OD 1 : 234 (mm)
OD 2 : 276 (mm)
ID 1 : 122.5 (mm)
ID 2 : 15 (mm)

CONT : 1
VOL : 0.037

67

A-8513 Air Filter Primary Soft PU end cap Element

YANMAR 119808-12520
NISSAN 16546-FJ100
KOMATSU 3EB-02-38730
SUNWARD 730403000157



Secondary Filter uses A-5569
Set Filter uses A-5570-S
H 1 : 273.5 (mm)
H 2 : 265 (mm)
OD 1 : 104 (mm)
OD 2 : 104 (mm)
ID 1 : 61 (mm)

CONT : 25
VOL : 0.110

Note : A-8513(with Flame Retardant Media)

72

A-7806 Air Filter Secondary Metal End Cap Element

YANMAR 119131-12520
ISUZU 14215-167
DAEWOO 2474-9014



Primary Filter uses AS-7805
Set Filter uses AS-5656-S
H 1 : 337 (mm)
H 2 : 330 (mm)
OD 1 : 85.5 (mm)
OD 2 : 85.5 (mm)
ID 1 : 57.5 (mm)
ID 2 : 17 (mm)

CONT : 25
VOL : 0.106

Note : Is a secondary Air Filter for AS-7805,AS-7813,A-7805

63

A-7956 Air Filter Secondary Metal End Cap Element

HITACHI 4209588
HITACHI 4247974



Primary Filter uses A-2708
Set Filter uses A-2711-S
H 1 : 249.7 (mm)
H 2 : 237 (mm)
OD 1 : 133.5 (mm)
OD 2 : 133.5 (mm)
ID 1 : 105 (mm)
ID 2 : 17 (mm)

CONT : 10
VOL : 0.060

68

A-8568 Air Filter Metal End Cap Element

KUBOTA 121422-12570
YANMAR 121422-12570
KUBOTA 15287-11490
CASE 167817A1
HITACHI 4311871



H 1 : 232 (mm)
H 2 : 228.5 (mm)
OD 1 : 62.5 (mm)
OD 2 : 62.5 (mm)
ID 1 : 49 (mm)
ID 2 : 17 (mm)

CONT : 25
VOL : 0.038

73

A-7809 Air Filter Secondary Metal End Cap Element

NISSAN 16546-Z5003
ATLAS COPCO 3216-708202
CATERPILLAR 3I-0069
JOHN DEERE T46317



Primary Filter uses A-7954
Set Filter uses A-7954-S
H 1 : 387.4 (mm)
H 2 : 381 (mm)
OD 1 : 116.5 (mm)
OD 2 : 116.5 (mm)
ID 1 : 88 (mm)
ID 2 : 17 (mm)

CONT : 25
VOL : 0.178

64

A-7964 Air Filter Secondary Metal End Cap Element

IVECO 08015449
MASSEY-FERGUSON 1093683M91
FIAT-ALLIS 1909964



Primary Filter uses AS-7988
Set Filter uses AS-7988-S
H 1 : 357 (mm)
H 2 : 355.5 (mm)
OD 1 : 105 (mm)
OD 2 : 85.5 (mm)
ID 1 : 73.5 (mm)
ID 2 : 17 (mm)

CONT : 25
VOL : 0.141

Note : Is a Secondary Air filter for AS-7988,AS-7813,AS-7805,AS-4304

69

A-8580 Air Filter Secondary Soft PU end cap Element

CATERPILLAR 142-1403
ATLAS COPCO 3222-1881-92
HITACHI 4466268



Primary Filter uses A-8579
Set Filter uses A-8579-S
H 1 : 500 (mm)
H 2 : 494 (mm)
OD 1 : 179 (mm)
OD 2 : 174 (mm)
ID 1 : 148 (mm)

CONT : 1
VOL : 0.019

Note : Is a Secondary Air filter of A-8579M,A-8665M

74

A-7902 Air Filter Secondary Metal End Cap Element

HITACHI 4331920
CATERPILLAR 9Y-7663



Primary Filter uses A-9217
Set Filter uses A-9217-S
H 1 : 563.35 (mm)
H 2 : 550.6 (mm)
OD 1 : 276 (mm)
OD 2 : 276 (mm)
ID 1 : 207.5 (mm)
ID 2 : 22.7 (mm)

CONT : 1
VOL : 0.048

65

A-7967 Air Filter Secondary Metal End Cap Element

ISUZU 1-14215089-0
NISSAN 16546-96065
KOBELCO 2446U250S-2



Primary Filter uses A-1828
Set Filter uses A-1840-S
H 1 : 495.7 (mm)
H 2 : 483 (mm)
OD 1 : 162.3 (mm)
OD 2 : 162.3 (mm)
ID 1 : 134 (mm)
ID 2 : 17 (mm)

CONT : 9
VOL : 0.152

70

A-8599 Air Filter Secondary Soft PU end cap Element

KUBOTA 119005-12571
CASE 133721A1
HITACHI 4326841



Primary Filter uses A-8505
Set Filter uses A-8602-S
H 1 : 303.5 (mm)
H 2 : 298 (mm)
OD 1 : 83 (mm)
OD 2 : 79 (mm)
ID 1 : 64 (mm)

CONT : 25
VOL : 0.076

Note : Is a Secondary Air filter for A-5669,A-8505

75

Sakura Filter

Technical Specification

A-8650 Air Filter Primary Soft PU end cap Element

JOHN DEERE F434394
CASE IH275809A1



Secondary Filter uses A-8651
Set Filter uses A-8652-S
H 1 : 524 (mm)
H 2 : 512 (mm)
OD 1 : 280 (mm)
OD 2 : 280 (mm)
ID 1 : 148 (mm)

CONT : 1
VOL : 0.047

Note : Is a long life version of A-5102

AS-1024 Air Filter Primary Metal End Cap Element With Sleeve

NISSAN 16546-96003
NISSAN 16546-96015
NISSAN 16546-96026



Secondary Filter uses A-6009
Set Filter uses AS-1024-S
H 1 : 418.7 (mm)
H 2 : 406 (mm)
OD 1 : 254 (mm)
OD 2 : 201.5 (mm)
ID 1 : 135.5 (mm)
ID 2 : 17 (mm)

CONT : 1
VOL : 0.031

AS-27170 Air Filter Primary Soft PU end cap Element

KATO 119-727001000
YANMAR 172B06-11510
HITACHI YD00001541



Secondary Filter uses A-27180
Set Filter uses AS-27170-S
H 1 : 301.5 (mm)
H 2 : 294 (mm)
OD 1 : 140 (mm)
OD 2 : 140 (mm)
ID 1 : 72 (mm)

CONT : 4
VOL : 0.036

A-8651 Air Filter Secondary Soft PU end cap Element

HITACHI 4459548
KOMATSU 600-185-4220
JOHN DEERE F434395
CASE IH275810A1



Primary Filter uses A-8650
Set Filter uses A-8652-S
H 1 : 502 (mm)
H 2 : 497 (mm)
OD 1 : 150 (mm)
OD 2 : 141.5 (mm)
ID 1 : 109 (mm)

CONT : 9
VOL : 0.134

Note : Is a long life version of A-5103

AS-1024-S Air Filter Set Metal End Cap Element With Sleeve

FIAT 1930751+1930790
KOMATSU 6131-82-7011
FIAT 70684732+1930790
JOHN DEERE T46316+T46317



Primary Filter uses AS-1024
Secondary Filter uses A-6009
H 1 : 418.7 (mm)
H 2 : 406 (mm)
OD 1 : 254 (mm)
OD 2 : 201.5 (mm)
ID 1 : 135.5 (mm)
ID 2 : 17 (mm)

CONT : 1
VOL : 0.031

AS-27170-S Air Filter Set Soft PU end cap Element

IHI 074526508+074526509



Primary Filter uses AS-27170
Secondary Filter uses A-27180
H 1 : 301.5 (mm)
H 2 : 294 (mm)
OD 1 : 140 (mm)
OD 2 : 140 (mm)
ID 1 : 62 (mm)

CONT : 4
VOL : 0.036

A-8652-S Air Filter Set Soft PU end cap Element

JOHN DEERE F434394 + F434395



Primary Filter uses A-8650
Secondary Filter uses A-8651
H 1 : 524 (mm)
H 2 : 512 (mm)
OD 1 : 280 (mm)
OD 2 : 280 (mm)
ID 1 : 148 (mm)

CONT : 1
VOL : 0.047

Note : Is a long life version of A-5102-S

AS-2205 Air Filter Primary Metal End Cap Element With Sleeve

ISUZU 1-14215014-0
YANMAR 121120-12901
KUBOTA 121420-12511



Secondary Filter uses A-8568
Set Filter uses AS-2206-S
H 1 : 264 (mm)
H 2 : 254 (mm)
OD 1 : 132 (mm)
OD 2 : 104 (mm)
ID 1 : 63 (mm)
ID 2 : 17 (mm)

CONT : 12
VOL : 0.073

AS-5102 Air Filter Primary Soft PU end cap Element With Sleeve

VOLVO 11110022
HITACHI 4459549



Secondary Filter uses A-5103
Set Filter uses AS-5102-S
H 1 : 522 (mm)
H 2 : 510 (mm)
OD 1 : 280 (mm)
OD 2 : 280 (mm)
ID 1 : 148 (mm)

CONT : 1
VOL : 0.047

AS-1010 Air Filter Metal End Cap Element With Sleeve

ISUZU 14215-132
CUMMINS 158876
NISSAN 16546-Z5001



H 1 : 266.7 (mm)
H 2 : 254 (mm)
OD 1 : 257 (mm)
OD 2 : 201.5 (mm)
ID 1 : 90.5 (mm)
ID 2 : 14 (mm)

CONT : 1
VOL : 0.021

Note : INN.DIAM=91/17MM Version Uses AS-1025,
INN.DIAM 116/13.5MM Version Uses AS-1037

AS-2212 Air Filter Primary Metal End Cap Element With Sleeve

FIAT 1930603
FIAT 71415282



Secondary Filter uses A-7809
Set Filter uses AS-2212-S
H 1 : 420 (mm)
H 2 : 407.5 (mm)
OD 1 : 254 (mm)
OD 2 : 278.5 (mm)
ID 1 : 135.5 (mm)
ID 2 : 15 (mm)

CONT : 1
VOL : 0.037

AS-5102-S Air Filter Set Soft PU end cap Element With Sleeve

VOLVO 11110022+11110023



Primary Filter uses AS-5102
Secondary Filter uses A-5103
H 1 : 522 (mm)
H 2 : 510 (mm)
OD 1 : 280 (mm)
OD 2 : 280 (mm)
ID 1 : 148 (mm)

CONT : 1
VOL : 0.050

AS-1014 Air Filter Primary Metal End Cap Element With Sleeve

ISUZU 1-14215135-0
TOYOTA 1001905
YANMAR 171064-12540



Secondary Filter uses A-7919
Set Filter uses AS-1014-S
H 1 : 288 (mm)
H 2 : 279 (mm)
OD 1 : 160 (mm)
OD 2 : 134 (mm)
ID 1 : 66.5 (mm)
ID 2 : 17 (mm)

CONT : 9
VOL : 0.090

AS-2212-S Air Filter Set Metal End Cap Element With Sleeve

FIAT 1930603+1930790



Primary Filter uses AS-2212
Secondary Filter uses A-7809
H 1 : 420 (mm)
H 2 : 407.5 (mm)
OD 1 : 254 (mm)
OD 2 : 278.5 (mm)
ID 1 : 135.5 (mm)
ID 2 : 15 (mm)

CONT : 1
VOL : 0.037

AS-5412 Air Filter Metal End Cap Element With Sleeve

YANMAR 124066-12510
ISEKI 1427-101-2840-0
KUBOTA 15221-11223



H 1 : 184.4 (mm)
H 2 : 178 (mm)
OD 1 : 109.4 (mm)
OD 2 : 83 (mm)
ID 1 : 45 (mm)
ID 2 : 15.3 (mm)

CONT : 25
VOL : 0.079

AS-5628 Air Filter Primary Metal End Cap Element With Sleeve

MAZDA 0727-23-603
ISUZU 1-14215028-0
ISUZU 1-14215032-0



Secondary Filter uses A-7611
Set Filter uses AS-5628-S
H 1 : 311 (mm)
H 2 : 305 (mm)
OD 1 : 199.3 (mm)
OD 2 : 155 (mm)
ID 1 : 88 (mm)
ID 2 : 17 (mm)

CONT : 12
VOL : 0.194

AS-5708 Air Filter Metal End Cap Element With Sleeve

CUMMINS 158877
CUMMINS 299353



H 1 : 266.75 (mm)
H 2 : 254 (mm)
OD 1 : 296 (mm)
OD 2 : 234 (mm)
ID 1 : 123 (mm)
ID 2 : 14 (mm)

CONT : 1
VOL : 0.027

Note : Sleeve On E/C "B" Type Uses AS-5709

AS-8579 Air Filter Primary Soft PU end cap Element With Sleeve

VOLVO 11033996
VOLVO BM 110339967
CATERPILLAR 142-1340



Secondary Filter uses A-8580
Set Filter uses AS-8579-S
H 1 : 521 (mm)
H 2 : 510 (mm)
OD 1 : 313 (mm)
OD 2 : 313 (mm)
ID 1 : 178 (mm)

CONT : 1
VOL : 0.057

AS-5643 Air Filter Primary Metal End Cap Element With Sleeve

KOMATSU 37Z-02-AF934A
KOMATSU 3EA-01-18130
HITACHI 4294846



Secondary Filter uses A-8568
Set Filter uses AS-5643-S
H 1 : 263.7 (mm)
H 2 : 251 (mm)
OD 1 : 131.5 (mm)
OD 2 : 148 (mm)
ID 1 : 63 (mm)
ID 2 : 17 (mm)

CONT : 16
VOL : 0.121

AS-7609 Air Filter Primary Metal End Cap Element With Sleeve

CATERPILLAR 3I-0228
FIAT 79022025



Secondary Filter uses A-7605
Set Filter uses AS-7609-S
H 1 : 315.9 (mm)
H 2 : 305 (mm)
OD 1 : 160 (mm)
OD 2 : 133.5 (mm)
ID 1 : 82 (mm)
ID 2 : 17 (mm)

CONT : 9
VOL : 0.110

AS-8579-S Air Filter Set Soft PU end cap Element With Sleeve

TEREX 15270188 + 15270189
HITACHI 76612497+4466268



Primary Filter uses AS-8579
Secondary Filter uses A-8580
H 1 : 521 (mm)
H 2 : 510 (mm)
OD 1 : 313 (mm)
OD 2 : 313 (mm)
ID 1 : 178 (mm)

CONT : 1
VOL : 0.057

AS-5643-S Air Filter Set Metal End Cap Element With Sleeve

CASE 167815A1+167817A1
KOMATSU
3EA-01-18130+3EB-02-19840
HITACHI 4294846+4311871
J.C.BAMFORD KAP0482+KAP0727
Primary Filter uses AS-5643
Secondary Filter uses A-8568
H 1 : 263.7 (mm)
H 2 : 251 (mm)
OD 1 : 131.5 (mm)
OD 2 : 148 (mm)
ID 1 : 63 (mm)
ID 2 : 17 (mm)



CONT : 16
VOL : 0.121

AS-7621 Air Filter Primary Metal End Cap Element With Sleeve

FIAT 1930602
DAEWOO 2471-9023
FIAT 70005585



Secondary Filter uses A-7619
Set Filter uses AS-7622-S
H 1 : 419.75 (mm)
H 2 : 407 (mm)
OD 1 : 296 (mm)
OD 2 : 317 (mm)
ID 1 : 153 (mm)
ID 2 : 15 (mm)

CONT : 1
VOL : 0.052

AS-8579M Air Filter Primary Soft PU+Metal Element With Sleeve

HITACHI 76612497



Secondary Filter uses A-8580
Set Filter uses AS-8579M-S
H 1 : 521 (mm)
H 2 : 510 (mm)
OD 1 : 313 (mm)
OD 2 : 313 (mm)
ID 1 : 178 (mm)

CONT : 1
VOL : 0.060

Note : with metal reinforcement

AS-5656-S Air Filter Set Metal End Cap Element With Sleeve

KOMATSU 600-181-9500



Primary Filter uses AS-7805
Secondary Filter uses A-7806
H 1 : 392 (mm)
H 2 : 381 (mm)
OD 1 : 199.3 (mm)
OD 2 : 155 (mm)
ID 1 : 88 (mm)
ID 2 : 17 (mm)

CONT : 9
VOL : 0.169

AS-7622-S Air Filter Set Metal End Cap Element With Sleeve

HITACHI 71420350 + 1930792



Primary Filter uses AS-7621
Secondary Filter uses A-7619
H 1 : 419.75 (mm)
H 2 : 407 (mm)
OD 1 : 296 (mm)
OD 2 : 317 (mm)
ID 1 : 153 (mm)
ID 2 : 15 (mm)

CONT : 1
VOL : 0.052

C-1011 Oil Filter Full Flow Spin-On

JAC 1017100GG010
NISSAN 15208-HC400
HINO 15607-1920
MAZDA JEYO-14-302



H 1 : 85 (mm)
OD 1 : 68 (mm)
Thread Size : M20X1.5-6H
BPV (kg/cm2) : 1.0
ADBV : YES
Gasket Type : Round

CONT : 50
VOL : 0.026

Note : Square version uses C-1030

AS-5707 Air Filter Metal End Cap Element With Sleeve

CUMMINS 158871
CUMMINS 158878
NISSAN 16546-M0800



H 1 : 317.7 (mm)
H 2 : 305 (mm)
OD 1 : 352 (mm)
OD 2 : 282 (mm)
ID 1 : 171 (mm)
ID 2 : 13.5 (mm)

CONT : 1
VOL : 0.046

AS-7805 Air Filter Primary Metal End Cap Element With Sleeve

IVECO 08014390
MASSEY-FERGUSON 1093682M91
ISUZU 14215-166



Secondary Filter uses A-7806
Set Filter uses AS-5656-S
H 1 : 392 (mm)
H 2 : 381 (mm)
OD 1 : 199 (mm)
OD 2 : 155 (mm)
ID 1 : 88 (mm)
ID 2 : 17 (mm)
Gasket Type : Square

CONT : 9
VOL : 0.169

Note : Long Life Versions Uses AS-7813

C-1303 Oil Filter Combination Spin-On

HINO 15607-1600
HINO 15607-1830



H 1 : 199 (mm)
OD 1 : 110 (mm)
Thread Size : 1 1/2-16 UN-2B

CONT : 6
VOL : 0.018

Note : single element version uses C-1325

Sakura Filter

Technical Specification

C-1312 Oil Filter Full Flow Spin-On

ISUZU 1-13200768-1
ISUZU 1-13240105-0
HINO 15607-1420



H 1 : 248 (mm)
OD 1 : 121 (mm)
Thread Size : 1 3/8-16 UNF-2B
Gasket Type : Square

CONT : 6
VOL : 0.032

Note : With Drain Nut

C-15680 Oil Filter By Pass Spin-On

J.C.BAMFORD 2800359
HITACHI 4429725
FIAT-HITACHI 71422692
NEW HOLLAND (CNH) 71422692
ISUZU 8-97026134-2



H 1 : 200 (mm)
OD 1 : 110 (mm)
Thread Size : M20X1.5-6H
Gasket Type : Square

CONT : 12
VOL : 0.042

C-2708 Oil Filter Combination Spin-On

HITACHI 4448336
HITACHI 4484495
HITACHI 4661256



H 1 : 210 (mm)
OD 1 : 120 (mm)
Thread Size : 1 1/2-12 UNF-2B
BPV (kg/cm2) : 1.0
Gasket Type : Square

CONT : 6
VOL : 0.026

Note : C-2705(bottom plate difference)

C-1327 Oil Filter By Pass Spin-On

ISUZU 1-13240163-0
ISUZU 1-13240163-1
ISUZU 1-13240163-2
HITACHI 4371313



H 1 : 248.8 (mm)
OD 1 : 120 (mm)
Thread Size : 1 3/8-16 UNF-2B
Gasket Type : Square

CONT : 6
VOL : 0.029

C-1806 Oil Filter Full Flow Spin-On

ISUZU 132400930
NISSAN 15209-J1800
NISSAN 15209-Y7500



H 1 : 164 (mm)
OD 1 : 80 (mm)
Thread Size : 3/4-16 UNF-2B
Gasket Type : Round

CONT : 36
VOL : 0.050

C-5102 Oil Filter Full Flow Spin-On

PERKINS 26540347
PERKINS 2654407



H 1 : 168 (mm)
OD 1 : 93 (mm)
Thread Size : 3/4-16 UNF-2B
BPV (kg/cm2) : 1.0
ADBV : YES
Gasket Type : Square

CONT : 25
VOL : 0.050

C-1506 Oil Filter By Pass Spin-On

ISUZU 1-13240048-1
ISUZU 1-13240048-2
ISUZU 1-13240059-0



H 1 : 162 (mm)
OD 1 : 110 (mm)
Thread Size : M20X1.5-6H
Gasket Type : Square

CONT : 12
VOL : 0.030

C-2702 Oil Filter Full Flow Spin-On

KOBELCO 2451U309-1
HITACHI 4183853
HITACHI 4439863



H 1 : 150 (mm)
OD 1 : 80 (mm)
Thread Size : 1-12 UNF-2B
BPV (kg/cm2) : 2.0 - 2.5
ADBV : YES
Gasket Type : Square

CONT : 12
VOL : 0.027

C-5201 Oil Filter By Pass Spin-On

mitsubishi 37540-02100



H 1 : 250 (mm)
OD 1 : 125 (mm)
Thread Size : 1 3/8-16 UNF-2B
Gasket Type : Square

CONT : 6
VOL : 0.034

Note : Is a long version of C-5809

C-1511 Oil Filter Full Flow Spin-On

ISUZU 8-94217272-0
ISUZU 8-94360426-0
ISUZU 8-94430983-0



H 1 : 100 (mm)
OD 1 : 90 (mm)
Thread Size : M20X1.5-6H
BPV (kg/cm2) : 1.0
ADBV : YES
Gasket Type : Round

CONT : 25
VOL : 0.029

C-2704 Oil Filter Combination Spin-On

HITACHI 4448336



H 1 : 252 (mm)
OD 1 : 120 (mm)
Thread Size : 1 1/2-12 UNF-2B
Gasket Type : Square

CONT : 6
VOL : 0.028

C-5205 Oil Filter Full Flow Spin-On

YANMAR 119305-35151



H 1 : 65 (mm)
OD 1 : 65 (mm)
Thread Size : M20X1.5-6H
BPV (kg/cm2) : 1.0
ADBV : YES
Gasket Type : Round

CONT : 50
VOL : 0.036

C-1538 Oil Filter Full Flow Spin-On

HOLDEN 8-9421-7272-2



H 1 : 95 (mm)
OD 1 : 93 (mm)
Thread Size : M20X1.5-6H
BPV (kg/cm2) : 1.0
ADBV : YES
Gasket Type : Square

CONT : 25
VOL : 0.037

Note : C-1503,C-1511 (bottom plate difference)

C-2706 Oil Filter Full Flow Spin-On

HITACHI 4429726



H 1 : 206 (mm)
OD 1 : 108 (mm)
Thread Size : 1 1/2-12 UNF-2B
Gasket Type : Square

CONT : 6
VOL : 0.020

Note : Drain Nut

C-5505 Oil Filter Full Flow Spin-On

CATERPILLAR 1R-0714
HITACHI 4429728
FIAT 71455273
MITSUBISHI ME034878
MITSUBISHI ME088519



H 1 : 162 (mm)
OD 1 : 108 (mm)
Thread Size : 1 1/8-16 UNF-2B
Gasket Type : Square

CONT : 12
VOL : 0.034

C-5703 Oil Filter Full Flow Spin-On



HYUNDAI 11E1-70110
GENERAL MOTORS 25011995
CUMMINS 3903224
KOMATSU 6732-51-5140
CASE J908616

H 1 : 135 (mm)
OD 1 : 93 (mm)
Thread Size : 1-16 UNF-2B
Gasket Type : Square

CONT : 12
VOL : 0.018

121

C-5715 Oil Filter Full Flow Spin-On



MTU 0031843001
CUMMINS 3313279
MITSUBISHI 37540-01101
CUMMINS 3889310
KOMATSU CULF-670

H 1 : 246 (mm)
OD 1 : 118 (mm)
Thread Size : 1 1/2-12 UNF-2B

CONT : 6
VOL : 0.029

Note : Height 286 MM Uses C-5701

126

C-6204 Oil Filter Full Flow Spin-On



MERCEDES-BENZ 001 184 96 01
DEUTZ 1173430
CATERPILLAR 5W-6017
ALLIS CHALMERS 61671600
EVOBUS 7.119.226.04

H 1 : 206 (mm)
OD 1 : 93 (mm)
Thread Size : 1-12 UNF-2B
BPV (kg/cm2) : 2.0 - 2.5
ADBV : YES
Gasket Type : Square

CONT : 25
VOL : 0.057

Note : With Grip

131

C-5704 Oil Filter Full Flow Spin-On Cellulose media



J.C.BAMFORD 02/910140
J.C.BAMFORD 02/910140A
CUMMINS 3903264

H 1 : 174 (mm)
OD 1 : 93 (mm)
Thread Size : 1-16 UNF-2B
Gasket Type : Square

CONT : 12
VOL : 0.023

Note : High Performance Grade Uses C-5730

122

C-5718 Oil Filter By Pass Spin-On



ISUZU 1-87310093-0
CATERPILLAR 1W-8845
J.C.BAMFORD 32/919502
HITACHI 4285964

H 1 : 246 (mm)
OD 1 : 115.5 (mm)
Thread Size : 1 3/8-16 UNF-2B

CONT : 6
VOL : 0.032

127

C-7105 Oil Filter Full Flow Spin-On



VOLVO 478736
VOLVO 478736-2
RENAULT 5 001 846 642

H 1 : 259 (mm)
OD 1 : 108 (mm)
Thread Size : 1 1/8-16 UNF-2B
Gasket Type : Square

CONT : 6
VOL : 0.026

132

C-5705 Oil Filter Combination Spin-On



FIAT 1902102
IVECO 1903629
IVECO 1903715
IVECO 1907584

H 1 : 211 (mm)
OD 1 : 108 (mm)
Thread Size : M30X2-6H
Gasket Type : Square

CONT : 6
VOL : 0.022

123

C-5723 Oil Filter Combination Spin-On



KOMATSU 6742-01-4120

H 1 : 280 (mm)
OD 1 : 121 (mm)
Thread Size : 2 1/4-12 UNF-2B
Gasket Type : Square

CONT : 6
VOL : 0.038

Note : C-5723 is upgrade version of C-5706

128

C-7303 Oil Filter Full Flow Spin-On



TEREX 15273756
DETROIT DIESEL 23526919
HITACHI E1297440

H 1 : 305 (mm)
OD 1 : 136 (mm)
Thread Size : 1 1/2-16 UN-2B
Gasket Type : Square

CONT : 6
VOL : 0.046

133

C-5707 Oil Filter Combination Spin-On Seamless



J.C.BAMFORD 02/910965
CUMMINS 3401544
KOMATSU 6742-01-4540

H 1 : 294 (mm)
OD 1 : 118 (mm)
Thread Size : 2 1/4-12 UNF-2B

CONT : 6
VOL : 0.029

Note : Multilayer

124

C-6001 Oil Filter Full Flow Spin-On



ISUZU 1-13240062-2
ISUZU 1-87811638-0

H 1 : 203 (mm)
OD 1 : 118 (mm)
Thread Size : 1 1/2-12 UNF-2B

CONT : 6
VOL : 0.025

129

C-7917 Oil Filter Full Flow Spin-On



IVECO 01901603
IVECO 1901603
IVECO 1907566

H 1 : 184 (mm)
OD 1 : 108 (mm)
Thread Size : 3/4-16 UNF-2B
ADBV : YES
Gasket Type : Square

CONT : 6
VOL : 0.020

134

C-5708 Oil Filter Full Flow Spin-On



J.C.BAMFORD 32/925413
CUMMINS 3937736

H 1 : 174 (mm)
OD 1 : 93 (mm)
Thread Size : 1 1/8-16 UNF-2B
Gasket Type : Square

CONT : 12
VOL : 0.027

Note : Glass Fiber media uses C-5733

125

C-6101 Oil Filter Full Flow Spin-On



NISSAN 15209-0T000
NISSAN 15209-T9000
NISSAN 15209-T9001

H 1 : 200 (mm)
OD 1 : 93 (mm)
Thread Size : 1-12 UNF-2B
ADBV : YES
Gasket Type : Round

CONT : 25
VOL : 0.056

130

C-7937 Oil Filter Combination Spin-On



IVECO 01902047
IVECO 01902076
FIAT 1902047
IVECO 1902076

H 1 : 143 (mm)
OD 1 : 108.5 (mm)
Thread Size : 3/4-16 UNF-2B
BPV (kg/cm2) : 2.0

CONT : 6
VOL : 0.015

135

Sakura Filter

Technical Specification

C-8012 Oil Filter Full Flow Spin-On



MAHINDRA 14501673990
HITACHI 26300-21010
HYUNDAI 26300-21010
CHRYSLER 4186267
MITSUBISHI 4253037

H 1 : 78 (mm)
OD 1 : 86 (mm)
Thread Size : M20X1.5-6H
BPV (kg/cm2) : 1.0
ADBV : YES
Gasket Type : Square

CONT : 36
VOL : 0.036

136

CA-27030 Cabin Air Filter Plastic framed Element



HITACHI 4643580
HITACHI 4S00685

H 1 : 55 (mm)
H 2 : 45 (mm)
Length 1 : 281 (mm)
Width 1 : 161 (mm)

CONT : 20
VOL : 0.064

Note : For Inside application

141

CA-56041 Cabin Air Filter Plastic framed Element



KOMATSU 14X-911-7750
KOMATSU 17M-911-3530
HITACHI 4234793
KOMATSU 569-076-1190
FIAT 71498266

H 1 : 51 (mm)
Length 1 : 220 (mm)
Width 1 : 163 (mm)

CONT : 20
VOL : 0.049

146

CA-2405 Cabin Air Filter Soft PU framed Element



VOLVO 11007388
VOLVO 110073889
VOLVO 1584575
VOLVO 1584575-3

H 1 : 45 (mm)
Length 1 : 268 (mm)
Width 1 : 188 (mm)

CONT : 20
VOL : 0.059

137

CA-27040 Cabin Air Filter Plastic framed Element



HITACHI 4350249
HITACHI 4S00640

H 1 : 71 (mm)
Length 1 : 346 (mm)
Width 1 : 254 (mm)

CONT : 10
VOL : 0.081

142

EF-1801 Fuel Filter Main Eco Element High Efficiency

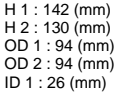

NISSAN 16444-NY025
HITACHI 4642641

H 1 : 142 (mm)
H 2 : 130 (mm)
OD 1 : 94 (mm)
OD 2 : 94 (mm)
ID 1 : 26 (mm)

CONT : 50
VOL : 0.078

Note : micron rating:nominal 4 micron,absolute 5.89

147

CA-27010 Cabin Air Filter Element

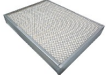

VOLVO 12583881
HITACHI 12630763
DEUTZ 70257109
FIAT 70257109
EUCLID E12583881

H 1 : 55.6 (mm)
Length 1 : 406 (mm)
Width 1 : 305 (mm)

CONT : 2
VOL : 0.017

138

CA-27050 Cabin Air Filter Plastic framed Element



HITACHI 4441139
HITACHI 4S00684

H 1 : 10 (mm)
Length 1 : 283.5 (mm)
Width 1 : 177.5 (mm)
Width 2 : 179 (mm)

CONT : 20
VOL : 0.021

143

EF-2634 Fuel Filter Eco Element High Efficiency

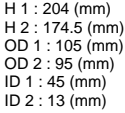

MERCEDES-BENZ 541 090 00 51
MERCEDES-BENZ 541 090 01 51
MERCEDES-BENZ 541 092 03 05

H 1 : 204 (mm)
H 2 : 174.5 (mm)
OD 1 : 105 (mm)
OD 2 : 95 (mm)
ID 1 : 45 (mm)
ID 2 : 13 (mm)

CONT : 25
VOL : 0.073

148

CA-27020 Cabin Air Filter Plastic framed Element



HITACHI 4632689
HITACHI 4S00686

H 1 : 75 (mm)
Length 1 : 320 (mm)
Width 1 : 216 (mm)

CONT : 20
VOL : 0.152

Note : For Outside application

139

CA-27060 Cabin Air Filter Plastic framed Element



HITACHI YA00001490

H 1 : 43 (mm)
Length 1 : 260 (mm)
Length 2 : 232 (mm)
Width 1 : 243 (mm)

CONT : 10
VOL : 0.050

144

EF-2701 Fuel Filter Primary Eco Element 14 micron

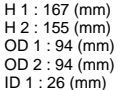

HITACHI 4649267
SUMITOMO KHH10590
KOBELCO YN21P01036R100

H 1 : 167 (mm)
H 2 : 155 (mm)
OD 1 : 94 (mm)
OD 2 : 94 (mm)
ID 1 : 26 (mm)

CONT : 25
VOL : 0.049

Note : EF-2701 media 14 micron,to upgrade use EF-27040(media 7 micron)

149

CA-27021 Cabin Air Filter Paper framed Element



HITACHI YA00032683

H 1 : 77 (mm)
Length 1 : 320 (mm)
Width 1 : 216 (mm)

CONT : 20
VOL : 0.170

Note : with foam

140

CA-55090 Cabin Air Filter Plastic Element



CATERPILLAR 245-8237
TCM 263G6-73191

H 1 : 23 (mm)
Length 1 : 245 (mm)
Width 1 : 203 (mm)

CONT : 20
VOL : 0.063

145

EF-27022 Fuel Filter Main Eco Element High Efficiency

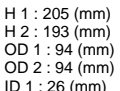

J.C.BAMFORD 332/G0652
HITACHI 4679981

H 1 : 205 (mm)
H 2 : 193 (mm)
OD 1 : 94 (mm)
OD 2 : 94 (mm)
ID 1 : 26 (mm)

CONT : 50
VOL : 0.117

Note : 4 micron

150

EF-27040 Fuel Filter Primary Eco Element High Efficiency

HITACHI 4649267
HITACHI 4676385
SUMITOMO KHH12030
KOBELCO YN21P01036R100

H 1 : 167 (mm)
H 2 : 155 (mm)
OD 1 : 94 (mm)
OD 2 : 94 (mm)
ID 1 : 26 (mm)

CONT : 25
VOL : 0.049

Note : 7 micron

F-1304 Fuel Filter Metal End Cap Element

HINO 23401-1020
HINO 23401-1021
HINO 23401-1080



H 1 : 109 (mm)
H 2 : 104 (mm)
OD 1 : 103 (mm)
OD 2 : 104 (mm)
ID 1 : 49 (mm)
ID 2 : 15 (mm)

CONT : 50
VOL : 0.080

F-2604 Fuel Filter Metal End Cap Element

MERCEDES-BENZ 000 477 40 15
MERCEDES-BENZ 000 477 45 15
MERCEDES-BENZ 355 470 01 92



H 1 : 145 (mm)
H 2 : 138 (mm)
OD 1 : 83 (mm)
OD 2 : 83 (mm)
ID 1 : 14 (mm)
ID 2 : 14 (mm)

CONT : 50
VOL : 0.062

EF-27050 Fuel Filter Main Eco Element High Efficiency

HITACHI 4719921
ISUZU 8981527380

H 1 : 142 (mm)
H 2 : 130 (mm)
OD 1 : 94 (mm)
OD 2 : 94 (mm)
ID 1 : 26 (mm)

CONT : 50
VOL : 0.081

Note : dual element/media

F-1503 Fuel Filter Metal End Cap Element

ISUZU 1-87810207-0
ISUZU 1-87810207-1
ISUZU 1-87810207-2



H 1 : 166 (mm)
H 2 : 160 (mm)
OD 1 : 101 (mm)
OD 2 : 101 (mm)
ID 1 : 14.5 (mm)
ID 2 : 14.5 (mm)

CONT : 50
VOL : 0.105

F-5202 Fuel Filter Metal End Cap Element

YANMAR 104500-55710
HITACHI 4294842
ISUZU 5-87810269-0
JOHN DEERE CH15553
FORD SBA130366040



H 1 : 69 (mm)
H 2 : 66.5 (mm)
OD 1 : 35 (mm)
OD 2 : 35 (mm)
ID 1 : 11 (mm)

CONT : 100
VOL : 0.015

Note :

EF-27060 Fuel Filter Main Eco Element High Efficiency

HITACHI 4719920
SUNWARD 750201011065
ISUZU 8981527370

H 1 : 205 (mm)
H 2 : 193 (mm)
OD 1 : 94 (mm)
OD 2 : 94 (mm)
ID 1 : 26 (mm)

CONT : 12
VOL : 0.037

Note : 4 Micron

F-1504 Fuel Filter Metal End Cap Element

ISUZU 1-13240008-0
ISUZU 1-87810027-0
ISUZU 1-87810027-1



H 1 : 138.5 (mm)
H 2 : 137.5 (mm)
OD 1 : 92 (mm)
OD 2 : 92 (mm)
ID 1 : 14.5 (mm)
ID 2 : 14.5 (mm)

CONT : 24
VOL : 0.037

F-5207 Fuel Filter Metal End Cap Element

YANMAR 119810-55650
YANMAR 124550-55700
KUBOTA 16271-43560



H 1 : 87.5 (mm)
H 2 : 85 (mm)
OD 1 : 35 (mm)
OD 2 : 35 (mm)
ID 1 : 11.5 (mm)

CONT : 50
VOL : 0.009

F-1302 Fuel Filter Metal End Cap Element

HINO 23401-1040
HINO 23401-1050
HINO 6052-2008-00



H 1 : 102 (mm)
H 2 : 100 (mm)
OD 1 : 71 (mm)
OD 2 : 71 (mm)
ID 1 : 15 (mm)
ID 2 : 15 (mm)

CONT : 50
VOL : 0.035

F-1803 Fuel Filter Metal End Cap Element

NISSAN 16444-90027
NISSAN 16444-99127
NISSAN 16444-99128



H 1 : 141 (mm)
H 2 : 134 (mm)
OD 1 : 91.5 (mm)
OD 2 : 91.5 (mm)
ID 1 : 14.5 (mm)
ID 2 : 14.5 (mm)

CONT : 50
VOL : 0.073

F-5210 Fuel Filter Metal End Cap Element

YANMAR 129100-55650
KUBOTA 15521-43160
KUBOTA 607



H 1 : 89 (mm)
OD 1 : 50 (mm)
OD 2 : 50 (mm)
ID 1 : 20 (mm)

CONT : 50
VOL : 0.017

F-1303 Fuel Filter Metal End Cap Element

ISUZU 13240-029
NISSAN 16403-90026
NISSAN 16444-90000
HINO 23401-1030



H 1 : 105 (mm)
OD 1 : 74 (mm)
OD 2 : 74 (mm)
ID 1 : 16 (mm)
ID 2 : 16 (mm)

CONT : 50
VOL : 0.040

F-2603 Fuel Filter Metal End Cap Element

MERCEDES-BENZ 000 477 31 15
DAIMLER BENZ 4220900051
STEYR-DAIMLER-PUCH 614080740



H 1 : 145 (mm)
H 2 : 130 (mm)
OD 1 : 84.5 (mm)
OD 2 : 84.5 (mm)
ID 1 : 13 (mm)
ID 2 : 13 (mm)

CONT : 50
VOL : 0.062

F-70020 Fuel Filter Metal End Cap Element

FIAT 1902096
IVECO 1902096
IVECO 1902096022
FIAT 1909107
NEW HOLLAND (CNH) 1909107



H 1 : 187 (mm)
H 2 : 177 (mm)
OD 1 : 91 (mm)
OD 2 : 91 (mm)
ID 1 : 26.3 (mm)
ID 2 : 12.8 (mm)

CONT : 25
VOL : 0.054

F-7909 Fuel Filter Metal End Cap Element



KUBOTA 15231-4356-0
KUBOTA 15231-4356-3
MITSUBISHI MM 404889

H 1 : 85 (mm)
OD 1 : 29 (mm)
OD 2 : 29 (mm)
ID 1 : 13 (mm)
ID 2 : 13 (mm)

CONT : 100
VOL : 0.011

166

FC-1206 Fuel Filter Spin-On



ATLAS COPCO 1092 6387 00
KUBOTA 15221-43080
KUBOTA 15221-43081
KUBOTA 15221-43170

H 1 : 75 (mm)
OD 1 : 80 (mm)
Thread Size : M20X1.5-6H
Gasket Type : Round

CONT : 50
VOL : 0.034

171

FC-1801 Fuel Filter Spin-On



NISSAN 16403-09W00
NISSAN 16403-27000

H 1 : 80 (mm)
OD 1 : 80 (mm)
Thread Size : 3/4-16 UNF-2B
Gasket Type : Round

CONT : 50
VOL : 0.037

176

F-7914 Fuel Filter Metal End Cap Element



POWERPUMP 8-94337-0220

H 1 : 35.6 (mm)
H 2 : 33 (mm)
OD 1 : 41 (mm)
OD 2 : 41 (mm)
ID 1 : 24.5 (mm)
ID 2 : 24.5 (mm)

CONT : 100
VOL : 0.010

167

FC-1501 Fuel Filter Spin-On



NISSAN 16403-89TA1
NISSAN 16403-J5500
HITACHI 4285643

H 1 : 87 (mm)
OD 1 : 80 (mm)
Thread Size : 3/4-16 UNF-2B
Gasket Type : Round

CONT : 50
VOL : 0.039

172

FC-1810 Fuel Filter Spin-On with head body



NISSAN 16403-99013
NISSAN 16403-NY001

H 1 : 145 (mm)
OD 1 : 93 (mm)
Thread Size : 1-14 UNS-2B
Gasket Type : Square

CONT : 12
VOL : 0.024

177

F-7930 Fuel Filter Metal End Cap Element



KOBELCO LS02P01012R100
KOBELCO LS02P01012S002
HITACHI YA00002973

H 1 : 144.5 (mm)
H 2 : 106.5 (mm)
OD 1 : 60 (mm)
OD 2 : 60 (mm)
ID 1 : 16 (mm)

CONT : 50
VOL : 0.034

168

FC-1503 Fuel Filter Spin-On High Efficiency



ISUZU 1-13240009-0
ISUZU 1-13240041-0

H 1 : 125 (mm)
OD 1 : 90 (mm)
Thread Size : 3/4-16 UNF-2B
Gasket Type : Round

CONT : 25
VOL : 0.035

173

FC-1824 Fuel Filter Spin-On



HITACHI 4S00203

H 1 : 89 (mm)
OD 1 : 76 (mm)
Thread Size : 3/4-16 UNF-2B
Gasket Type : Square

CONT : 50
VOL : 0.041

178

FC-1005 Fuel Filter Spin-On



HITACHI 4326739
NISSAN AY500-MT502
CASE-IH CNH KHH10030
SUMITOMO KHH10030

H 1 : 172 (mm)
OD 1 : 93.2 (mm)
Thread Size : M24X1.5-6H
Gasket Type : Square

CONT : 25
VOL : 0.052

Note : For high efficiency version, use FC-10270

169

FC-15031 Fuel Filter Spin-On



ISUZU 1-13200688-0
ISUZU 1-13240074-0
ISUZU 1-13240079-1
HITACHI 4206080
GENERAL MOTORS 94392474

H 1 : 125 (mm)
OD 1 : 90 (mm)
Thread Size : 3/4-16 UNF-2B
Gasket Type : Square

CONT : 12
VOL : 0.020

Note : FC-1503(Bottom plate difference)

174

FC-2202 Fuel Filter Spin-On



IVECO 190 4640
IVECO 190 7640
IVECO 193 0953

H 1 : 147 (mm)
OD 1 : 76 (mm)
Thread Size : M16X1.5-6H
Gasket Type : Square

CONT : 25
VOL : 0.034

179

FC-1006 Fuel Filter Spin-On



SUZUKI 15410-78E00
SUZUKI 15411-78E00

H 1 : 120 (mm)
OD 1 : 80 (mm)
Thread Size : M20X1.5-6H
Thread Nut Size : M22X1.5-6H
Gasket Type : Round

CONT : 50
VOL : 0.053

170

FC-1702 Fuel Filter Can-type Housing



VW GROUP 061 198 552
NISSAN 16403-76200
VOLVO 236628
VOLVO 236628/4

H 1 : 71 (mm)
OD 1 : 84 (mm)
OD 2 : 86.5 (mm)
ID 1 : 19.5 (mm)
ID 2 : 19.5 (mm)

CONT : 50
VOL : 0.036

Note : rolled paper version

175

FC-2702 Fuel Filter Spin-On



HITACHI 4206130
ISUZU 8-94453738-1
ISUZU 8-94453738-2

H 1 : 80 (mm)
OD 1 : 90 (mm)
Thread Size : 3/4-16 UNF-2B
Gasket Type : Round

CONT : 36
VOL : 0.033

Note : Different Height With FC-2701

180

FC-2703 Fuel Filter Spin-On With Nut
HITACHI 4192631



H 1 : 182.7 (mm)
H 2 : 175 (mm)
OD 1 : 93 (mm)
Thread Size : 1-14 UNS-2B
Gasket Type : Square

CONT : 12
VOL : 0.028

181

FC-5704 Fuel Filter Spin-On
VOLVO 241672
VOLVO 243004
MASSEY-FERGUSON 2871513M1



H 1 : 123 (mm)
OD 1 : 76 (mm)
Thread Size : M16X1.5-6H
Gasket Type : Square

CONT : 50
VOL : 0.047

Note : With Center Tube

186

FC-58010 Fuel Filter Spin-On High Efficiency
MITSUBISHI 32562-60300



H 1 : 145 (mm)
OD 1 : 93.4 (mm)
Thread Size : 1-14 UNS-2B
Gasket Type : Square

CONT : 12
VOL : 0.022

191

FC-27050 Fuel Filter Spin-On
HITACHI YA00029016



H 1 : 172 (mm)
OD 1 : 93 (mm)
Thread Size : 1 1/8-16 UNF-2B
Gasket Type : Round

CONT : 20
VOL : 0.055

182

FC-5715 Fuel Filter Spin-On With Drain Plug
KHD(KLOCKNER-HUMBOLT-DEUTZ) 1174482
J.C.BAMFORD 32/912001



H 1 : 163 (mm)
OD 1 : 81.5 (mm)
Thread Size : M16X1.5-6H
Thread Nut Size : M8X1.25
Gasket Type : Square

CONT : 25
VOL : 0.037

187

FC-6501 Fuel Filter Primary Spin-On
GENERAL MOTORS 25014274
GENERAL MOTORS 6438839



Secondary Filter uses FC-6502

H 1 : 203 (mm)
OD 1 : 93 (mm)
Thread Size : 1-12 UNF-2B
Gasket Type : Square

CONT : 12
VOL : 0.028

192

FC-27060 Fuel Filter Spin-On With Nut
ISUZU 8-98312918-0
ISUZU 8982394641
SUMITOMO MMH80990
HITACHI YA00033486



H 1 : 199 (mm)
OD 1 : 108 (mm)
Thread Size : M82X1.5-6H

CONT : 12
VOL : 0.042

183

FC-5720 Fuel Filter Spin-On
CUMMINS 154709
CUMMINS 3315844



H 1 : 135 (mm)
OD 1 : 93 (mm)
Thread Size : 1-14 UNS-2B
Gasket Type : Square

CONT : 12
VOL : 0.021

Note : Is a short version of FC-57270

188

FC-6502 Fuel Filter Secondary Spin-On
GENERAL MOTORS 25010778
GENERAL MOTORS 6438840



Primary Filter uses FC-6501

H 1 : 175 (mm)
OD 1 : 93 (mm)
Thread Size : 13/16-12 UNF-2B
Gasket Type : Square

CONT : 12
VOL : 0.025

193

FC-5103 Fuel Filter Can-type Housing
ALLIS CHALMERS 1919100
MANITOU 49660
CASE K915319



H 1 : 71 (mm)
OD 1 : 85 (mm)
OD 2 : 89 (mm)
ID 1 : 39 (mm)
ID 2 : 15 (mm)

CONT : 50
VOL : 0.036

184

FC-5723 Fuel Filter Spin-On
LOMBARDINI 276-2175-046
VOLVO 7243004-4



H 1 : 122 (mm)
OD 1 : 76 (mm)
Thread Size : M16X1.5-6H
Gasket Type : Square

CONT : 50
VOL : 0.047

Note : High Performance versions uses FC-25060

189

FC-6505 Fuel Filter Spin-On
GENERAL MOTORS 23518528
GENERAL MOTORS 25011024



H 1 : 228 (mm)
OD 1 : 118 (mm)
Thread Size : 1 1/4-12 UNF-2B
Gasket Type : Square

CONT : 6
VOL : 0.027

194

FC-5702 Fuel Filter Spin-On
MITSUBISHI 32540-20300
MITSUBISHI 32562-20300
HITACHI 4085912



H 1 : 175 (mm)
OD 1 : 93 (mm)
Thread Size : 1-14 UNS-2B
Gasket Type : Square

CONT : 12
VOL : 0.030

Note : Drain nut

185

FC-57290 Fuel Filter Spin-On High Efficiency
CUMMINS 4964234



H 1 : 262 (mm)
OD 1 : 118 (mm)
Thread Size : 2 1/4-12 UNF-2B

CONT : 6
VOL : 0.032

190

FC-6507 Fuel Filter Spin-On With Microfiber media
DETROIT DIESEL 23518529
HITACHI E12980183-1



H 1 : 228 (mm)
OD 1 : 118 (mm)
Thread Size : 1 1/6-16 UNG-2B
Gasket Type : Square

CONT : 6
VOL : 0.028

195

Sakura Filter

Technical Specification

FC-7903 Fuel Filter Secondary Spin-On High Efficiency

J.C.BAMFORD 02/910155
CUMMINS 3903640
CUMMINS 3931063



H 1 : 115 (mm)
OD 1 : 76 (mm)
Thread Size : M16X1.5-6H
Gasket Type : Square

CONT : 25
VOL : 0.023

196

H-2704 Hydraulic Oil Filter Metal End Cap Element

DAEWOO 2474-9003B
DAEWOO 2474-9008
HITACHI 4227353



H 1 : 456 (mm)
H 2 : 438 (mm)
OD 1 : 112 (mm)
OD 2 : 112 (mm)
ID 1 : 66.1 (mm)
ID 2 : 66.1 (mm)

CONT : 10
VOL : 0.079

201

H-2714 Hydraulic Oil Filter Wire Mesh supported Element

HITACHI 4190987



H 1 : 128 (mm)
H 2 : 89 (mm)
OD 1 : 150 (mm)
OD 2 : 150 (mm)
ID 1 : 73.4 (mm)

CONT : 9
VOL : 0.044

206

FC-9800 Fuel Filter Spin-On

FIAT 01909103
IVECO 1901605
FIAT 1909119



H 1 : 185 (mm)
OD 1 : 108 (mm)
Thread Size : 3/4-16 UNF-2B
Gasket Type : Square

CONT : 6
VOL : 0.019

197

H-2705 Hydraulic Oil Filter Metal End Cap Element

HITACHI 4225846
KOBELCO H 403



H 1 : 358 (mm)
H 2 : 344 (mm)
OD 1 : 90 (mm)
OD 2 : 90 (mm)
ID 1 : 47 (mm)
ID 2 : 47 (mm)

CONT : 20
VOL : 0.088

202

H-2719 Hydraulic Oil Filter Metal End Cap Element Cellulose media

HYUNDAI 31E3-0018
HITACHI 4294135
YAMASHIN DT-04-10-10



H 1 : 87 (mm)
H 2 : 83.5 (mm)
OD 1 : 42.5 (mm)
OD 2 : 42.5 (mm)
ID 1 : 21.5 (mm)

CONT : 50
VOL : 0.011

Note : Wiremesh type uses H-5211

207

FS-5701 Fuel Filter Metal body In-Line

CUMMINS 3826094
NEW HOLLAND (CNH) 86597473



H 1 : 96 (mm)
OD 1 : 44.5 (mm)
Inlet : 10 (mm)
Outlet : 10 (mm)

CONT : 12
VOL : 0.005

198

H-2706 Hydraulic Oil Filter Suction Wire Mesh supported Element

YANMAR 172162-73700
HITACHI 4210224



H 1 : 134.8 (mm)
H 2 : 128 (mm)
OD 1 : 150 (mm)
OD 2 : 150 (mm)
ID 1 : 87 (mm)
Thread Size : M10X1.5-6H

CONT : 6
VOL : 0.028

203

H-2720 Hydraulic Oil Filter Metal End Cap Element

HITACHI 4488239



H 1 : 111.5 (mm)
H 2 : 108.5 (mm)
OD 1 : 42.5 (mm)
OD 2 : 42.5 (mm)
ID 1 : 21.5 (mm)

CONT : 50
VOL : 0.016

208

H-2702 Hydraulic Oil Filter Metal End Cap Element

DAEWOO 2474-1001
HITACHI 4159320
KOBELCO H 409



H 1 : 123.6 (mm)
H 2 : 113 (mm)
OD 1 : 73 (mm)
OD 2 : 73 (mm)
ID 1 : 34 (mm)
ID 2 : 34 (mm)

CONT : 50
VOL : 0.030

199

H-2709 Hydraulic Oil Filter Metal End Cap Element

KOMATSU 07063-01383
KOMATSU 208-60-61150
HITACHI 4287634
HITACHI 76580323



H 1 : 450 (mm)
OD 1 : 180 (mm)
OD 2 : 180 (mm)
ID 1 : 110 (mm)
ID 2 : 110 (mm)

CONT : 9
VOL : 0.173

204

H-2724 Hydraulic Oil Filter Metal End Cap Element

HITACHI 4656605
HITACHI 4656608



H 1 : 450 (mm)
H 2 : 437 (mm)
OD 1 : 154 (mm)
OD 2 : 150 (mm)
ID 1 : 95 (mm)
ID 2 : 98 (mm)

CONT : 6
VOL : 0.079

Note : High performance grade uses H-27241

209

H-2703 Hydraulic Oil Filter Metal End Cap Element

HITACHI 4207841
HITACHI 4207841A
HITACHI 4370435



H 1 : 152 (mm)
H 2 : 146.5 (mm)
OD 1 : 51 (mm)
OD 2 : 51 (mm)
ID 1 : 23.5 (mm)

CONT : 25
VOL : 0.015

200

H-2712 Hydraulic Oil Filter Metal End Cap Element

MANITOU 15512-00703
HITACHI 4294130



H 1 : 52 (mm)
H 2 : 48.5 (mm)
OD 1 : 42.5 (mm)
OD 2 : 42.5 (mm)
ID 1 : 21.5 (mm)

CONT : 50
VOL : 0.007

205

H-2727 Hydraulic Oil Filter Element Cellulose media

HITACHI 4206705
HITACHI 4287061
KOMATSU F25701500
SUMITOMO KRJ 3836



H 1 : 455 (mm)
H 2 : 450 (mm)
OD 1 : 150 (mm)
OD 2 : 150 (mm)
ID 1 : 110 (mm)
ID 2 : 110 (mm)

CONT : 6
VOL : 0.085

210

H-2730 Hydraulic Oil Filter Metal End Cap Element
HITACHI 4185299



H 1 : 304 (mm)
H 2 : 254 (mm)
OD 1 : 140 (mm)
OD 2 : 140 (mm)
ID 1 : 20 (mm)
ID 2 : 20 (mm)

CONT : 4
VOL : 0.034

211

H-27410 Hydraulic Oil Filter Plastic Element
HITACHI E12596702



H 1 : 421 (mm)
H 2 : 406 (mm)
OD 1 : 80 (mm)
OD 2 : 80 (mm)
ID 1 : 49 (mm)

CONT : 12
VOL : 0.048

216

H-7981 Hydraulic Oil Filter Return Metal End Cap Element
HITACHI 4443773
HITACHI 4448402
SUNWARD 730401000068
SANY B222100000233
XGMA EF-058



H 1 : 464.5 (mm)
H 2 : 431 (mm)
OD 1 : 156 (mm)
OD 2 : 150 (mm)
ID 1 : 98 (mm)

CONT : 6
VOL : 0.078

Note : BPV=1.5 kgf/cm2

221

H-27360 Hydraulic Oil Filter Wire Mesh supported Element
HITACHI 4648651



H 1 : 135.5 (mm)
H 2 : 127 (mm)
OD 1 : 125 (mm)
OD 2 : 125 (mm)
ID 1 : 87 (mm)
Thread Size : M10X1.5-6H

CONT : 25
VOL : 0.076

212

H-5107 Hydraulic Oil Filter Element With Microfiber media
VOLVO 11707544
J.C.BAMFORD 32/917701
J.C.BAMFORD 6900/0084



H 1 : 112 (mm)
H 2 : 108 (mm)
OD 1 : 51 (mm)
OD 2 : 51 (mm)
ID 1 : 23 (mm)

CONT : 50
VOL : 0.022

217

H-85970 Hydraulic Oil Filter Transmission Metal End Cap Element
ALLISON 23018853
GENERAL MOTORS 23018853
ALLISON 23049374
GENERAL MOTORS 23049374



H 1 : 426.5 (mm)
H 2 : 424 (mm)
OD 1 : 95 (mm)
OD 2 : 95 (mm)
ID 1 : 55 (mm)

CONT : 12
VOL : 0.057

222

H-27380 Hydraulic Oil Filter Return Metal End Cap Element
HITACHI YA00033065



H 1 : 461.5 (mm)
H 2 : 431 (mm)
OD 1 : 154 (mm)
OD 2 : 150 (mm)
ID 1 : 98 (mm)

CONT : 6
VOL : 0.080

Note : BPV=1.5 kgf/cm2

213

H-5505 Hydraulic Oil Filter Metal End Cap Element
CATERPILLAR 094-4412
HITACHI 4219713



H 1 : 455 (mm)
H 2 : 450 (mm)
OD 1 : 150 (mm)
OD 2 : 150 (mm)
ID 1 : 110 (mm)
ID 2 : 110 (mm)

CONT : 6
VOL : 0.081

Note : With outer packing 1 pc

218

H-85990 Hydraulic Oil Filter Metal End Cap Element With Microfiber media
PALL HC8904FKS16H



H 1 : 413 (mm)
H 2 : 400 (mm)
OD 1 : 104 (mm)
OD 2 : 97 (mm)
ID 1 : 62 (mm)

CONT : 12
VOL : 0.039

223

H-27390 Hydraulic Oil Filter Return Metal End Cap Element
HITACHI YA00033064



H 1 : 461.5 (mm)
H 2 : 431 (mm)
OD 1 : 150 (mm)
OD 2 : 154 (mm)
ID 1 : 98 (mm)

CONT : 6
VOL : 0.081

214

H-7911 Hydraulic Oil Filter Metal End Cap Element
KOMATSU 07063-01210
KOMATSU 205-60-51430



H 1 : 450 (mm)
OD 1 : 150 (mm)
OD 2 : 150 (mm)
ID 1 : 110 (mm)
ID 2 : 110 (mm)

CONT : 6
VOL : 0.080

Note : Without gasket

219

HC-2701 Hydraulic Oil Filter Transmission Spin-On
HITACHI 4230376
HITACHI 4286837
KOMATSU BW252116



H 1 : 200 (mm)
OD 1 : 93 (mm)
Thread Size : 1-12 UNF-2B
Thread Nut Size : M24X1.5
BPV (kgf/cm2) : 2.5
Gasket Type : Square

CONT : 12
VOL : 0.036

224

H-27400 Hydraulic Oil Filter Metal End Cap Element
HITACHI 263E7-52011



H 1 : 183 (mm)
OD 1 : 150 (mm)
OD 2 : 150 (mm)
ID 1 : 110 (mm)
ID 2 : 110 (mm)

CONT : 0
VOL : 0.000

215

H-7912 Hydraulic Oil Filter Metal End Cap Element
HITACHI 3502410-N
KOBELCO H 401



H 1 : 291 (mm)
H 2 : 277 (mm)
OD 1 : 90 (mm)
OD 2 : 90 (mm)
ID 1 : 46.6 (mm)
ID 2 : 46.6 (mm)

CONT : 20
VOL : 0.077

220

HC-2709 Hydraulic Oil Filter Spin-On Cellulose media
HITACHI 4630525



H 1 : 168 (mm)
OD 1 : 82.5 (mm)
Thread Size : M68X2-6H

CONT : 12
VOL : 0.020

225

Sakura Filter

Technical Specification

HC-27100 Hydraulic Oil Filter Spin-On

HITACHI 4252563
HITACHI 71497010



H 1 : 147.5 (mm)
H 2 : 136 (mm)
OD 1 : 93 (mm)
Thread Size : 1 1/8-16 UNF-2B

CONT : 12
VOL : 0.025

226

HC-7901 Hydraulic Oil Filter Spin-On

INTERNATIONAL HARVESTER
075912103
KOBELCO 2446U141S2



H 1 : 130 (mm)
OD 1 : 93 (mm)
Thread Size : 1 1/8-16 UNF-2B
Gasket Type : Round

CONT : 12
VOL : 0.020

Note : Seat assy zinc coating

231

O-1505 Oil Filter Full Flow Metal End Cap Element

ISUZU 9-13240098-0
ISUZU 9-13240106-0
ISUZU 9-13240106-1



H 1 : 177 (mm)
H 2 : 161 (mm)
OD 1 : 104.5 (mm)
OD 2 : 104 (mm)
ID 1 : 49 (mm)
ID 2 : 15 (mm)

CONT : 50
VOL : 0.111

236

HC-5602 Hydraulic Oil Filter Spin-On

KOMATSU 113-60-43320
KOMATSU 113-60-43321
KOMATSU 209-607-6210
HITACHI 4205684
KUBOTA 68773-62230



H 1 : 171 (mm)
OD 1 : 125 (mm)
Thread Size : M48X2-6H

CONT : 6
VOL : 0.026

227

HC-7913 Hydraulic Oil Filter Spin-On

CLARK 234099
CATERPILLAR 311980
J.C.BAMFORD 4110147
FIAT 906041007



H 1 : 140 (mm)
OD 1 : 93.5 (mm)
Thread Size : 2-16 UNF-2B
Gasket Type : Square

CONT : 12
VOL : 0.024

232

O-1506 Oil Filter Full Flow Metal End Cap Element

ISUZU 1-87810059-0
ISUZU 1-87810059-1
ISUZU 1-87810065-0



H 1 : 248.5 (mm)
H 2 : 232 (mm)
OD 1 : 104.5 (mm)
OD 2 : 104 (mm)
ID 1 : 49 (mm)
ID 2 : 15 (mm)

CONT : 25
VOL : 0.085

237

HC-5807 Hydraulic Oil Filter Spin-On

MITSUBISHI 91004-10021
YSK IHI-075511900
MITSUBISHI LPF 010



H 1 : 141 (mm)
OD 1 : 93 (mm)
Thread Size : 1 1/8-16 UNF-2B
Gasket Type : Round

CONT : 25
VOL : 0.046

228

O-1301 Oil Filter Full Flow Metal End Cap Element

ISUZU 1-13240109-1
NISSAN 15208-61501
NISSAN 15208-61525
NISSAN 15208-Z5000
NISSAN 15208-Z9025



H 1 : 165 (mm)
H 2 : 160 (mm)
OD 1 : 104 (mm)
OD 2 : 104 (mm)
ID 1 : 15 (mm)
ID 2 : 49 (mm)

CONT : 50
VOL : 0.104

233

O-1510 Oil Filter By Pass Can-type Depth

ISUZU 1-87810050-0
ISUZU 1-87810050-1
ISUZU 1-87810050-2



H 1 : 330 (mm)
H 2 : 297 (mm)
OD 1 : 164 (mm)
OD 2 : 164 (mm)
Thread Size : M16X1.0-6H

CONT : 6
VOL : 0.072

238

HC-69031 Hydraulic Oil Filter Spin-On With Microfiber media

HYUNDAI 46321-22015
INGERSOLL RAND 575129311
CATERPILLAR 77-5795



H 1 : 147.5 (mm)
OD 1 : 94 (mm)
Thread Size : 1 1/2-16 UN-2B

CONT : 12
VOL : 0.023

Note : 5 micron

229

O-1310 Oil Filter By Pass Metal End Cap Element

HINO 15607-1350
HINO 15607-1351
HINO 15607-1530



H 1 : 218 (mm)
OD 1 : 122 (mm)
OD 2 : 122 (mm)
ID 1 : 17.5 (mm)
ID 2 : 17.5 (mm)

CONT : 16
VOL : 0.074

234

O-1804 Oil Filter By Pass Can-type Depth

NISSAN 15274-90127
NISSAN 15274-90129
NISSAN 15274-99428



H 1 : 145 (mm)
OD 1 : 97 (mm)
OD 2 : 97 (mm)
ID 1 : 15 (mm)
ID 2 : 15 (mm)

CONT : 50
VOL : 0.099

239

HC-76130 Hydraulic Oil Filter Transmission Spin-On With Microfiber media

ZF 0501323154
J.C.BAMFORD 32925905
CASE 8603535
CASE 87519452
JOHN DEERE AT336140



H 1 : 199 (mm)
OD 1 : 94.5 (mm)
Thread Size : 1 3/8-12 UNF-2B
Thread Stud Size : M24X1.5

CONT : 12
VOL : 0.024

230

O-1503 Oil Filter Full Flow Metal End Cap Element

ISUZU 13240-085/1
ISUZU 5-87310336-0
ISUZU 5-87810239-0



H 1 : 146 (mm)
H 2 : 143 (mm)
OD 1 : 83 (mm)
OD 2 : 83 (mm)
ID 1 : 17 (mm)
ID 2 : 17 (mm)

CONT : 50
VOL : 0.062

235

O-2701 Oil Filter By Pass Metal End Cap Element

HITACHI 4231195



H 1 : 168 (mm)
H 2 : 131 (mm)
OD 1 : 165 (mm)
OD 2 : 165 (mm)
Thread Size : M16X2-6H

CONT : 16
VOL : 0.105

Note : Multi layer version uses O-2709

240

Sakura Filter

Technical Specification

O-2702 Oil Filter By Pass Metal End Cap Element



HINO 15607-1660
HITACHI 4208241
HITACHI 4208241-1

H 1 : 192.5 (mm)
H 2 : 155.5 (mm)
OD 1 : 165 (mm)
OD 2 : 165 (mm)
Thread Size : M16X1.0-6H

CONT : 6
VOL : 0.116

241

SFC-5301-10 Fuel/Water Separator Spin-On 10 Micron



MERCEDES-BENZ 000 470 04 69
MERCEDES-BENZ A 000 470 04 69
MERCEDES-BENZ A 000 477 13 02
MERCEDES-BENZ R90-MER-01

H 1 : 217 (mm)
OD 1 : 108 (mm)
Thread Size : 1-14 UNS-2B

CONT : 6
VOL : 0.022

Note : bowl not included

246

SFC-5707 Fuel/Water Separator Spin-On With Drain Plug



MTU 0010925601
CUMMINS 3309437
CUMMINS 3313304
HITACHI 4202934

H 1 : 311.4 (mm)
H 2 : 286 (mm)
OD 1 : 115.5 (mm)
Thread Size : 1 1/4-12 UNF-2B
Gasket Type : Square

CONT : 6
VOL : 0.036

251

O-5704 Oil Filter By Pass Can-type Depth



CUMMINS 101855
SUMITOMO 136750
CUMMINS 256838

H 1 : 382 (mm)
H 2 : 376 (mm)
OD 1 : 197 (mm)
OD 2 : 197 (mm)
ID 1 : 22 (mm)
ID 2 : 22 (mm)

CONT : 6
VOL : 0.111

242

SFC-5301-10B Fuel/Water Separator Spin-On With Bowl 10 Micron



MERCEDES-BENZ 000 470 04 69
MERCEDES-BENZ A 000 470 04 69
MERCEDES-BENZ R90-MER-01

H 1 : 308 (mm)
H 2 : 217 (mm)
OD 1 : 108 (mm)
Thread Size : 1-14 UNS-2B

CONT : 6
VOL : 0.029

Note : SFC-5301-10 and FB-1813

247

SFC-5709-10 Fuel/Water Separator Spin-On 10 Micron



CATERPILLAR 256-8753
CUMMINS 3329289
HITACHI 4377880

H 1 : 245 (mm)
OD 1 : 93 (mm)
Thread Size : 1-14 UNS-2B
Gasket Type : Square

CONT : 6
VOL : 0.019

252

O-6503 Oil Filter Full Flow Metal End Cap Element



GENERAL MOTORS 357304
GENERAL MOTORS 5573014
GENERAL MOTORS 5573102

H 1 : 231 (mm)
H 2 : 227 (mm)
OD 1 : 109.5 (mm)
OD 2 : 109.5 (mm)
ID 1 : 37 (mm)
ID 2 : 37 (mm)

CONT : 12
VOL : 0.043

Note : Metal Protector

243

SFC-5601-02 Fuel/Water Separator Spin-On High Efficiency



CUMMINS 3089916
KOMATSU 600-311-3110
KOMATSU 600-311-3111
KOMATSU 600-319-3111A

H 1 : 311.4 (mm)
H 2 : 286 (mm)
OD 1 : 118 (mm)
Thread Size : 1 1/4-12 UNF-2B

CONT : 6
VOL : 0.039

Note : High efficiency filter for high pressure fuel injection systems

248

SFC-5711 Fuel/Water Separator Spin-On



CUMMINS 3973233
CASE 87356193
NEW HOLLAND (CNH) 87356194

H 1 : 164 (mm)
OD 1 : 93 (mm)
Thread Size : 1-14 UNS-2B
Gasket Type : Square

CONT : 12
VOL : 0.032

253

SF-1912-30 Fuel/Water Separator Primary Plastic Element 30 Micron



HITACHI 4448737

H 1 : 244 (mm)
OD 1 : 111 (mm)
OD 2 : 128 (mm)
ID 1 : 16.5 (mm)
ID 2 : 21.15 (mm)

CONT : 25
VOL : 0.116

244

SFC-5705 Fuel/Water Separator Spin-On



ISUZU 1-13240044-1
CUMMINS 3308638
CUMMINS 3315843
SUNWARD 750201011130

H 1 : 174 (mm)
OD 1 : 93 (mm)
Thread Size : 1-14 UNS-2B
Gasket Type : Square

CONT : 12
VOL : 0.026

249

SFC-76130 Fuel/Water Separator Spin-On



LIEBHERR 7382112
JOHN DEERE RE508633
JOHN DEERE RE58376
JOHN DEERE RE62423

H 1 : 200 (mm)
H 2 : 172 (mm)
OD 1 : 80 (mm)
ID 1 : 17 (mm)

CONT : 25
VOL : 0.044

Note : standard flow

254

SF-27010 Fuel/Water Separator Metal End Cap Element



DETROIT DIESEL 23533816
MACK 301-SD-19B
ALLIANCE ABP/N10G-FS19624
HITACHI E12981308

H 1 : 181.5 (mm)
H 2 : 173.5 (mm)
OD 1 : 101 (mm)
OD 2 : 99.5 (mm)
ID 1 : 16.8 (mm)

CONT : 25
VOL : 0.064

Note : 7 micron

245

SFC-5706 Fuel/Water Separator Spin-On



J.C.BAMFORD 02/910150
J.C.BAMFORD 02/910150A
HYUNDAI 11E1-70210
CUMMINS 3935274
LIUGONG 53C0051

H 1 : 163.7 (mm)
H 2 : 134 (mm)
OD 1 : 93 (mm)
OD 2 : 92.7 (mm)
Thread Size : 13/16-18 UNF-2B
Thread Nut Size : M14X2
Gasket Type : Square

CONT : 12
VOL : 0.021

250

WC-5703 Coolant Filter Spin-On



CUMMINS 3318319
HITACHI 4266063
KOMATSU 6742-01-3490

H 1 : 136 (mm)
OD 1 : 93 (mm)
Thread Size : 11/16-16 UNF-2B
Gasket Type : Square

CONT : 12
VOL : 0.020

Note : Coolants = 23 units

255

WC-5705 Coolant Filter Spin-On

CUMMINS 299080
 CUMMINS 3100304
 CUMMINS 3305367



H 1 : 100 (mm)
 OD 1 : 93 (mm)
 Thread Size : 11/16-16 UNF-2B
 Gasket Type : Square

CONT : 12
 VOL : 0.018

Note : Coolants = 4 units

256

WC-5708 Coolant Filter Spin-On

GENERAL MOTORS 23507189
 FIAT 4393504
 CASE 441365C1



H 1 : 136 (mm)
 OD 1 : 93 (mm)
 Thread Size : 11/16-16 UNF-2B
 Gasket Type : Square

CONT : 12
 VOL : 0.027

Note : Coolant = 15 units

257

WC-5711 Coolant Filter Spin-On

CUMMINS 3315115
 CUMMINS 3316462
 CUMMINS 4058964



H 1 : 100 (mm)
 OD 1 : 93 (mm)
 Thread Size : 11/16-16 UNF-2B
 Gasket Type : Square

CONT : 12
 VOL : 0.014

Note : Coolants = 8 units

258

WC-5712 Coolant Filter Spin-On

CUMMINS 3100307
 CUMMINS 3315114
 CUMMINS 3316053



H 1 : 135 (mm)
 OD 1 : 93 (mm)
 Thread Size : 11/16-16 UNF-2B
 Gasket Type : Square

CONT : 12
 VOL : 0.020

Note : Coolants = 12 units

259

WC-5713 Coolant Filter Spin-On

HITACHI 4228689
 INGERSOLL RAND 57165805



H 1 : 136 (mm)
 OD 1 : 93 (mm)
 Thread Size : 11/16-16 UNF-2B
 Gasket Type : Square

CONT : 12
 VOL : 0.022

Note : Coolants = 15 units

260