

# VECTOR

PREMIUM QUALITY  
FILTERS



## KOMATSU

FILTER SUB-CATALOGUE



# Table of Contents

Engine Application .....  
Technical Specification .....

<b>A</b>
<b>B</b>

# Engine Application

A

MODEL/APPLICATION	SAKURA NO	MODEL/APPLICATION	SAKURA NO	MODEL/APPLICATION	SAKURA NO
<b>KOMATSU</b>		<b>KOMATSU</b>		<b>KOMATSU</b>	
<b>100-2</b> (EXCAVATORS) S4D105-5		Fuel Filter.....	FC-5403	Fuel Filter Secondary.....	F-6502
Air Filter Primary.....	AS-1024	<b>101G</b> (MOTOR GRADERS) V-504		Hydraulic Oil Filter Transmission....	H-65030
Air Filter Set.....	AS-1024-S	Fuel Filter.....	FC-1303	Oil Filter Full Flow.....	O-6503
Air Filter Secondary.....	A-6009	Fuel Filter.....	FC-5720	<b>118 SERIES B</b> (MOTOR GRADERS) 4-71	
Fuel Filter.....	FC-5604	Fuel/Water Separator.....	SFC-5705	Fuel Filter Secondary.....	F-6502
Hydraulic Oil Filter.....	H-56600	Oil Filter Full Flow.....	O-5702	Fuel Filter.....	F-6505
Hydraulic Oil Filter.....	H-5610	<b>104</b> (MOTOR GRADERS) DETROIT DIESEL		Hydraulic Oil Filter Transmission....	H-65030
Oil Filter Full Flow.....	C-5614	Fuel Filter Secondary.....	F-6502	Oil Filter Full Flow.....	O-6503
<b>100L-1</b> (EXCAVATORS) S4D105-5		Fuel Filter.....	F-6505	Oil Filter By Pass.....	O-5704
Air Filter Primary.....	AS-1024	Oil Filter Full Flow.....	O-6503	<b>118 SERIES B</b> (MOTOR GRADERS) H-135CL/7601	
Air Filter Set.....	AS-1024-S	<b>1046</b> (TRACTORS)		Hydraulic Oil Filter Transmission....	H-65030
Air Filter Secondary.....	A-6009	Air Filter Secondary.....	A-5309	Oil Filter Full Flow.....	O-5702
Fuel Filter.....	FC-5604	Air Filter Primary.....	A-6201	<b>118 SERIES B</b> (MOTOR GRADERS) NHC4/7601	
Hydraulic Oil Filter.....	H-56600	Fuel Filter.....	FC-5715	Hydraulic Oil Filter Transmission....	H-65030
Hydraulic Oil Filter.....	H-5610	<b>1046A</b> (TRACTORS)		Oil Filter Full Flow.....	O-5702
Oil Filter Full Flow.....	C-5614	Air Filter Secondary.....	A-5309	<b>120-1</b> (EXCAVATORS) S4D105-5	
<b>100L-2</b> (EXCAVATORS) S4D105-5		Air Filter Primary.....	A-6201	Air Filter Primary.....	AS-1024
Air Filter Primary.....	AS-1024	Fuel Filter.....	FC-5715	Air Filter Secondary.....	A-6009
Air Filter Secondary.....	A-6009	<b>10HQ-2</b> (EXCAVATORS) 4D92		Air Filter Set.....	AS-1024-S
Air Filter Set.....	AS-1024-S	Air Filter Primary.....	AS-1014	Fuel Filter.....	FC-5604
Fuel Filter.....	FC-5604	Fuel Filter.....	FC-5604	Hydraulic Oil Filter.....	H-56600
Hydraulic Oil Filter.....	H-56600	Hydraulic Oil Filter.....	H-5607	Hydraulic Oil Filter.....	H-5610
Hydraulic Oil Filter.....	H-5610	Oil Filter Full Flow.....	C-5606	Oil Filter Full Flow.....	C-5614
Oil Filter Full Flow.....	C-5614	<b>10HT</b> (EXCAVATORS) 4D130-1		<b>125</b> (CRANES)	
<b>100N1</b> (EXCAVATORS) S4D105-5		Fuel Filter.....	F-1501	Fuel Filter.....	FC-5403
Air Filter Secondary.....	A-6009	Hydraulic Oil Filter.....	H-5611	<b>125C</b> (LOADERS) D239	
Air Filter Primary.....	AS-1024	<b>10HT</b> (EXCAVATORS) 4D92		Fuel Filter.....	FC-5103
Air Filter Set.....	AS-1024-S	Air Filter Primary.....	AS-1014	Fuel Filter.....	FC-5403
Fuel Filter.....	FC-5604	Fuel Filter.....	FC-5604	<b>125B SERIES II</b> (LOADERS) D239	
Hydraulic Oil Filter.....	H-56600	Hydraulic Oil Filter.....	H-5607	Air Filter Secondary.....	A-76560
Hydraulic Oil Filter.....	H-5610	Oil Filter Full Flow.....	C-5606	<b>125E</b> (LOADERS) DT239	
Oil Filter Full Flow.....	C-5614	<b>10HW-2</b> (EXCAVATORS) 4D92		Fuel Filter.....	FC-5103
<b>100U-2</b> (EXCAVATORS) S4D105-5		Air Filter Primary.....	AS-1014	Fuel Filter.....	FC-5403
Air Filter Primary.....	AS-1024	Fuel Filter.....	FC-5604	<b>12HD-2</b> (EXCAVATORS) S4S105	
Air Filter Set.....	AS-1024-S	Hydraulic Oil Filter.....	H-5607	Air Filter Secondary.....	A-6009
Air Filter Secondary.....	A-6009	Oil Filter Full Flow.....	C-5606	Air Filter Primary.....	AS-1024
Fuel Filter.....	FC-5604	<b>10HW-1</b> (EXCAVATORS) 4D130-1		Air Filter Set.....	AS-1024-S
Hydraulic Oil Filter.....	H-5610	Fuel Filter.....	F-1501	Fuel Filter.....	FC-5605
Hydraulic Oil Filter.....	H-56600	Hydraulic Oil Filter.....	H-5611	Oil Filter Full Flow.....	C-5606
Oil Filter Full Flow.....	C-5614	<b>10HQ</b> (EXCAVATORS) 4D130-1		<b>12HL</b> (EXCAVATORS) S4S105	
<b>100C</b> (LOADERS) D206		Fuel Filter.....	F-1501	Air Filter Secondary.....	A-6009
Fuel Filter.....	FC-5103	Hydraulic Oil Filter.....	H-5611	Air Filter Set.....	AS-1024-S
Fuel Filter.....	FC-5403	<b>10HW-1</b> (EXCAVATORS) 4D130-1		Air Filter Primary.....	AS-1024
<b>100A</b> (LOADERS) D264		Fuel Filter.....	F-1501	Fuel Filter.....	FC-5605
Air Filter Secondary.....	A-5624	Hydraulic Oil Filter.....	H-5611	Oil Filter Full Flow.....	C-5606
<b>100B SERIES II</b> (LOADERS) D206		<b>111A</b> (MOTOR GRADERS) 4-71N		<b>12HL</b> (EXCAVATORS) S4S105	
Air Filter Secondary.....	A-76560	Fuel Filter.....	F-6503	Air Filter Secondary.....	A-6009
<b>100E</b> (LOADERS) D239		Fuel Filter.....	F-6505	Air Filter Set.....	AS-1024-S
Air Filter Secondary.....	A-76560			Air Filter Primary.....	AS-1024
				Fuel Filter.....	FC-5605
				Oil Filter Full Flow.....	C-5606

MODEL/APPLICATION	SAKURA NO	MODEL/APPLICATION	SAKURA NO	MODEL/APPLICATION	SAKURA NO
<b>KOMATSU</b>		<b>KOMATSU</b>		<b>KOMATSU</b>	
<b>12HT</b> (EXCAVATORS) S4S105		<b>160 SERIES B</b> (MOTOR GRADERS) CUMMINS		Air Filter Primary.....	A-5413
Air Filter Primary.....	AS-1024	Fuel Filter.....	FC-5720	Fuel Filter.....	FC-1810
Air Filter Set.....	AS-1024-S	Fuel Filter.....	FC-1303	Fuel Filter.....	FC-7933
Air Filter Secondary.....	A-6009	Fuel/Water Separator.....	SFC-5705	Fuel/Water Separator.....	SFC-5705
Fuel Filter.....	FC-5605	Oil Filter Full Flow.....	O-5702	Hydraulic Oil Filter.....	H-5406
Oil Filter Full Flow.....	C-5606				
<b>140M</b> (DUMP TRUCKS) KTA-19C		<b>160 SERIES C</b> (MOTOR GRADERS) 6-71		<b>175C</b> (LOADERS) DT466B	
Air Filter Secondary.....	A-5715	Fuel Filter.....	F-6505	Air Filter Primary.....	A-5413
Air Filter Primary.....	A-5718	Fuel Filter.....	F-6503	Air Filter Secondary.....	A-5414
Fuel Filter.....	FC-5702	Hydraulic Oil Filter Transmission...	H-65030	Air Filter Set.....	A-5660-S
Fuel/Water Separator.....	SFC-5709-10	Oil Filter Full Flow.....	O-6503	Fuel Filter.....	FC-1810
Fuel/Water Separator.....	SFC-5705			Fuel Filter.....	FC-7933
Oil Filter By Pass.....	C-5718	<b>160 SERIES C</b> (MOTOR GRADERS) CUMMINS		Fuel/Water Separator.....	SFC-5705
Oil Filter Full Flow.....	C-5715	Fuel Filter.....	FC-1303	Hydraulic Oil Filter.....	H-5406
		Fuel Filter.....	FC-5720		
<b>150 SERIES A</b> (MOTOR GRADERS) 4-53		Fuel/Water Separator.....	SFC-5705	<b>180</b> (MOTOR GRADERS) 12V-71	
Fuel Filter.....	F-6505	Oil Filter Full Flow.....	O-5702	Fuel Filter.....	F-6504
Fuel Filter Secondary.....	F-6502			Oil Filter Full Flow.....	O-6503
		<b>160 SERIES L</b> (MOTOR GRADERS) 6-71			
<b>150A</b> (CRANES)		Fuel Filter.....	F-6503	<b>201</b> (TRACTORS)	
Fuel Filter.....	F-5701	Fuel Filter.....	F-6505	Oil Filter Full Flow.....	O-7901
Oil Filter By Pass.....	O-5705	Hydraulic Oil Filter Transmission...	H-65030	Oil Filter Full Flow.....	O-1803
		Oil Filter Full Flow.....	O-6503		
<b>150CT</b> (DUMP TRUCKS) C221		<b>160 SERIES L</b> (MOTOR GRADERS) CUMMINS		<b>210LC</b> (EXCAVATORS)	
Fuel Filter.....	F-5501	Fuel Filter.....	FC-5720	Air Filter Set.....	AS-5672-S
		Fuel Filter.....	FC-1303	Air Filter Secondary.....	A-5671
<b>150FA</b> (CRANES)		Fuel/Water Separator.....	SFC-5705	Air Filter Primary.....	AS-5670
Fuel Filter.....	F-5701	Oil Filter Full Flow.....	O-5702	Fuel Filter Secondary.....	FC-7903
Oil Filter By Pass.....	O-5705			Fuel/Water Separator.....	SFC-5708
		<b>165</b> (LOADERS) D310		Fuel/Water Separator.....	SFC-5706
<b>160</b> (MOTOR GRADERS) 6-71		Fuel Filter.....	FC-5103	Hydraulic Oil Filter.....	H-7911
Fuel Filter.....	F-6503	Hydraulic Oil Filter Transmission...	H-65030	Hydraulic Oil Filter.....	H-85680
Fuel Filter.....	F-6505				
Hydraulic Oil Filter Transmission...	H-65030	<b>175B</b> (LOADERS) D361		<b>210M</b> (DUMP TRUCKS) KTTA-19C	
Oil Filter Full Flow.....	O-6503	Air Filter Primary.....	AS-5628	Fuel Filter.....	FC-5702
		Air Filter.....	A-85370	Fuel/Water Separator.....	SFC-5709-10
<b>160</b> (MOTOR GRADERS) CUMMINS		Air Filter Primary.....	A-5628	Fuel/Water Separator.....	SFC-5705
Fuel Filter.....	FC-5720	Air Filter Set.....	A-5628-S	Oil Filter By Pass.....	C-5718
Fuel Filter.....	FC-1303			Oil Filter Full Flow.....	C-5715
Fuel/Water Separator.....	SFC-5705	<b>175B</b> (LOADERS) DT407			
Oil Filter Full Flow.....	O-5702	Air Filter.....	A-85370	<b>220-2</b> (EXCAVATORS) S6D105-1	
		Fuel Filter.....	FC-1810	Air Filter Secondary.....	A-5408
<b>160 Series A</b> (MOTOR GRADERS) 6-71		Fuel/Water Separator.....	SFC-5705	Air Filter Primary.....	A-6113
Fuel Filter.....	F-6505			Hydraulic Oil Filter.....	H-5609
Fuel Filter.....	F-6503	<b>175B</b> (LOADERS) UD-407		Hydraulic Oil Filter.....	H-85680
Hydraulic Oil Filter Transmission...	H-65030	Air Filter Primary.....	AS-5628	Hydraulic Oil Filter.....	H-7911
Oil Filter Full Flow.....	O-6503	Air Filter.....	A-85370	Hydraulic Oil Filter.....	H-7911
		Air Filter Primary.....	A-5628	Oil Filter Full Flow.....	C-5614
<b>160 Series A</b> (MOTOR GRADERS) CUMMINS		Air Filter Set.....	A-5628-S		
Fuel Filter.....	FC-1303	Fuel Filter.....	FC-1810	<b>220LC-3</b> (EXCAVATORS) S6D105-1	
Fuel Filter.....	FC-5720	Fuel/Water Separator.....	SFC-5705	Air Filter Secondary.....	A-5408
Fuel/Water Separator.....	SFC-5705			Air Filter Primary.....	A-6113
Oil Filter Full Flow.....	O-5702	<b>175C</b> (LOADERS) DT466		Hydraulic Oil Filter.....	H-85680
		Air Filter Secondary.....	A-5414	Hydraulic Oil Filter.....	H-7911
		Air Filter Set.....	A-5660-S	Hydraulic Oil Filter.....	H-5609
				Oil Filter Full Flow.....	C-5614
				<b>222G</b> (MOTOR GRADERS) 8V-71T	

# Sakura Filter

# ENGINE APPLICATION

MODEL/APPLICATION	SAKURA NO	MODEL/APPLICATION	SAKURA NO	MODEL/APPLICATION	SAKURA NO
<b>KOMATSU</b>		<b>KOMATSU</b>		<b>KOMATSU</b>	
<b>222G</b> (MOTOR GRADERS) 8V-71T		Fuel Filter Secondary.....	FC-54050	Air Filter.....	A-8545
Air Filter Set.....	A-7912-S	Fuel/Water Separator.....	SFC-5705	Hydraulic Oil Filter Transmission....	H-65030
Air Filter Secondary.....	A-7915	Oil Filter Full Flow.....	C-5402	<b>295 SERIES B</b> (MOTOR GRADERS)	
Air Filter Primary.....	A-7912	<b>250E</b> (LOADERS) LTA10		Fuel Filter.....	FC-1810
Fuel Filter.....	F-6503	Air Filter Primary.....	A-5420	Fuel/Water Separator.....	SFC-5705
Fuel Filter Secondary.....	FC-6502	Air Filter Set.....	A-5420-S	Hydraulic Oil Filter Transmission....	H-65030
Fuel Filter.....	F-7302	Fuel Filter.....	FC-5720	<b>2FD25S-5</b> (FORKLIFTS)	
Fuel Filter.....	F-6505	Fuel/Water Separator.....	SFC-5705	Air Filter Primary.....	AS-2205
Fuel Filter Primary.....	FC-6501	Oil Filter By Pass.....	C-5718	Fuel Filter.....	FC-1802
Fuel/Water Separator.....	SFC-7301	Oil Filter Full Flow.....	C-5715	<b>300-2</b> (EXCAVATORS) NT-855	
Hydraulic Oil Filter Transmission....	H-65030	<b>2514B</b> (LOADERS)		Air Filter Primary.....	A-6113
Oil Filter Full Flow.....	O-6503	Oil Filter Full Flow.....	C-5814	Air Filter Secondary.....	A-5408
<b>229G</b> (MOTOR GRADERS) 8V-71T		Oil Filter Full Flow.....	C-5405	Fuel Filter.....	FC-5602
Air Filter Primary.....	A-7912	<b>252FT</b> (MOTOR GRADERS) FRONT ENGINE		Hydraulic Oil Filter.....	H-7911
Air Filter Set.....	A-7912-S	Air Filter Primary.....	A-7912	Hydraulic Oil Filter.....	H-85680
Air Filter Secondary.....	A-7915	Air Filter Set.....	A-7912-S	Oil Filter By Pass.....	O-5704
Fuel Filter.....	F-6505	Air Filter Secondary.....	A-7915	Oil Filter Full Flow.....	C-5715
Fuel Filter.....	F-6503	Fuel Filter.....	F-6503	Oil Filter Full Flow.....	C-5701
Fuel Filter Secondary.....	FC-6502	Fuel Filter Secondary.....	FC-6502	Oil Filter Full Flow.....	C-5605
Fuel Filter.....	F-7302	Fuel Filter.....	F-7302	<b>300LC-1</b> (EXCAVATORS) NT-855	
Fuel Filter Primary.....	FC-6501	Fuel Filter Primary.....	FC-6501	Air Filter Secondary.....	A-5408
Fuel/Water Separator.....	SFC-7301	Fuel/Water Separator.....	SFC-7301	Air Filter Primary.....	A-6113
Hydraulic Oil Filter Transmission....	H-65030	Oil Filter Full Flow.....	O-6503	Fuel Filter.....	FC-5602
Oil Filter Full Flow.....	O-6503	<b>252FT</b> (MOTOR GRADERS) REAR ENGINE		Hydraulic Oil Filter.....	H-7911
<b>2400A</b> (LOADERS)		Air Filter Secondary.....	A-5417	Hydraulic Oil Filter.....	H-85680
Fuel Filter.....	FC-5403	Air Filter Primary.....	A-5425	Oil Filter Full Flow.....	C-5715
Fuel Filter.....	FC-5103	Fuel Filter.....	F-6503	Oil Filter Full Flow.....	C-5701
Oil Filter Full Flow.....	C-5405	Fuel Filter.....	F-7302	Oil Filter Full Flow.....	C-5605
Oil Filter Full Flow.....	C-5814	Fuel Filter Primary.....	FC-6501	Oil Filter By Pass.....	O-5704
<b>240A</b> (LOADERS)		Fuel Filter Secondary.....	FC-6502	<b>321</b> (LOADERS)	
Fuel Filter.....	FC-5715	Fuel/Water Separator.....	SFC-7301	Fuel Filter.....	F-2601
Fuel Filter.....	FC-5103	Hydraulic Oil Filter Transmission....	H-65030	Fuel Filter.....	FC-5103
Oil Filter Full Flow.....	C-5405	Oil Filter Full Flow.....	O-6503	Oil Filter Full Flow.....	C-1122
Oil Filter Full Flow.....	C-5814	<b>260A</b> (LOADERS)		<b>323</b> (LOADERS)	
<b>2412B</b> (LOADERS)		Fuel Filter.....	FC-5103	Fuel Filter.....	F-2601
Fuel Filter.....	FC-5103	Oil Filter Full Flow.....	C-5814	Fuel Filter.....	FC-5103
Fuel Filter.....	FC-5403	Oil Filter Full Flow.....	C-5405	Oil Filter Full Flow.....	C-1122
Oil Filter Full Flow.....	C-5814	<b>270</b> (MOTOR GRADERS) DVT-573		<b>330</b> (DUMP TRUCKS) CUMMINS	
Oil Filter Full Flow.....	C-5405	Air Filter.....	A-5410	Fuel Filter.....	F-5701
<b>2500A</b> (LOADERS)		Fuel Filter.....	FC-1810	Fuel Filter.....	FC-1303
Oil Filter Full Flow.....	C-5405	Fuel/Water Separator.....	SFC-5705	Fuel Filter.....	FC-5720
Oil Filter Full Flow.....	C-5814	Hydraulic Oil Filter Transmission....	H-65030	Fuel/Water Separator.....	SFC-5705
<b>250A</b> (LOADERS)		<b>270A</b> (LOADERS)		Hydraulic Oil Filter Transmission....	H-65030
Hydraulic Oil Filter.....	H-5406	Fuel Filter.....	FC-5403	Oil Filter Full Flow.....	O-6503
Oil Filter Full Flow.....	C-5405	Hydraulic Oil Filter.....	H-5406	Oil Filter Full Flow.....	O-5702
Oil Filter Full Flow.....	C-5814	<b>270 D</b> (MOTOR GRADERS)		Oil Filter Full Flow.....	C-8031
<b>250C</b> (LOADERS) DVT-573B		Fuel Filter.....	FC-5103	<b>330</b> (DUMP TRUCKS) DETROIT DIESEL	
Air Filter Primary.....	A-5405	<b>295</b> (MOTOR GRADERS) DT817		Fuel Filter.....	F-6503
Air Filter Secondary.....	A-5406	Fuel Filter.....	FC-5103	Fuel Filter.....	F-6505
Air Filter Set.....	A-5405-S			Fuel Filter Secondary.....	F-6502

# Sakura Filter

# ENGINE APPLICATION

MODEL/APPLICATION	SAKURA NO	MODEL/APPLICATION	SAKURA NO	MODEL/APPLICATION	SAKURA NO
<b>KOMATSU</b>		<b>KOMATSU</b>		<b>KOMATSU</b>	
<b>330</b> (DUMP TRUCKS) DETROIT DIESEL		Fuel/Water Separator.....	SFC-5705	Oil Filter Full Flow.....	0-1803
Oil Filter Full Flow.....	0-6503	Hydraulic Oil Filter Transmission...	H-65030	<b>4125</b> (LOADERS) B48 GAS	
<b>330</b> (DUMP TRUCKS) KTA38		Oil Filter Full Flow.....	0-5702	Oil Filter Full Flow.....	C-6210
Fuel Filter.....	FC-5703	Oil Filter Full Flow.....	C-8031	<b>4135</b> (LOADERS) NHC GAS	
Fuel/Water Separator.....	SFC-5707	<b>353</b> (LOADERS)		Oil Filter Full Flow.....	C-6210
Fuel/Water Separator.....	SFC-5601-02	Fuel Filter.....	F-2603	<b>4130</b> (LOADERS) NHCV	
Oil Filter By Pass.....	0-5704	Oil Filter Full Flow.....	C-1122	Air Filter.....	AS-5412
<b>330H</b> (MOTOR GRADERS) CUMMINS		<b>35C</b> (DUMP TRUCKS) DETROIT DIESEL		Oil Filter Full Flow.....	C-1828
Fuel Filter.....	F-5701	Fuel Filter.....	F-6504	<b>4130</b> (LOADERS) S6D170-1(QTY 2) GAS	
Fuel Filter.....	FC-1303	Hydraulic Oil Filter Transmission...	H-65030	Oil Filter Full Flow.....	C-1828
Fuel Filter.....	FC-5720	Oil Filter Full Flow.....	0-6503	Oil Filter Full Flow.....	C-6210
Fuel/Water Separator.....	SFC-5705	<b>3600A</b> (LOADERS)		<b>4140</b> (LOADERS) 3AB1	
Hydraulic Oil Filter Transmission...	H-65030	Oil Filter Full Flow.....	C-5814	Air Filter Primary.....	AS-2205
Oil Filter Full Flow.....	0-6503	<b>385</b> (DUMP TRUCKS) KTA38		Oil Filter Full Flow.....	C-6210
Oil Filter Full Flow.....	C-8031	Fuel Filter.....	FC-5703	<b>4140</b> (LOADERS) H105 GAS	
Oil Filter Full Flow.....	0-5702	Fuel/Water Separator.....	SFC-5707	Air Filter Primary.....	AS-2205
<b>330H</b> (MOTOR GRADERS) DETROIT DIESEL		Fuel/Water Separator.....	SFC-5601-02	Oil Filter Full Flow.....	C-1828
Fuel Filter.....	F-6503	Oil Filter By Pass.....	0-5704	Oil Filter Full Flow.....	C-6210
Fuel Filter.....	F-6505	<b>3960</b> (EXCAVATORS)		<b>4150</b> (LOADERS) DF172	
Fuel Filter Secondary.....	F-6502	Air Filter Primary.....	AS-5628	Air Filter Primary.....	AS-1014
Oil Filter Full Flow.....	0-6503	Air Filter Primary.....	A-5628	Oil Filter Full Flow.....	C-1914
<b>330M</b> (DUMP TRUCKS) KTA-38C		Air Filter Set.....	A-5628-S	Oil Filter Full Flow.....	C-7602
Fuel/Water Separator.....	SFC-5601-02	<b>3964</b> (EXCAVATORS)		<b>4150</b> (LOADERS) GF172	
Fuel/Water Separator.....	SFC-5707	Air Filter Primary.....	AS-5628	Air Filter Primary.....	AS-1014
Oil Filter Full Flow.....	C-5715	Air Filter Primary.....	A-5628	Oil Filter Full Flow.....	C-1914
Oil Filter By Pass.....	C-5718	Air Filter Set.....	A-5628-S	Oil Filter Full Flow.....	C-7602
<b>333CSF</b> (MOTOR GRADERS) 12V-71T		Fuel Filter.....	FC-5403	<b>4150</b> (LOADERS) M4-121G	
Fuel Filter.....	F-7302	<b>3964B</b> (EXCAVATORS) D358		Oil Filter Full Flow.....	C-6210
Fuel Filter.....	F-6504	Fuel Filter.....	FC-5715	<b>423</b> (LOADERS)	
Oil Filter Full Flow.....	0-6503	Hydraulic Oil Filter.....	H-5406	Fuel Filter.....	F-2603
<b>333F</b> (MOTOR GRADERS) 12V-71T		<b>3964B-LGP</b> (EXCAVATORS) D358		Oil Filter Full Flow.....	C-1122
Fuel Filter.....	F-6504	Fuel Filter.....	FC-5715	<b>431</b> (MOTOR GRADERS)	
Fuel Filter.....	F-7302	Hydraulic Oil Filter.....	H-5406	Fuel Filter Secondary.....	FC-54050
Oil Filter Full Flow.....	0-6503	<b>3965B</b> (EXCAVATORS) D358		Fuel/Water Separator.....	SFC-5705
<b>333FT</b> (MOTOR GRADERS) 12V-71 FRONT & REAR		Fuel Filter.....	FC-5715	Hydraulic Oil Filter.....	H-5406
Air Filter Secondary.....	A-5610	Hydraulic Oil Filter.....	H-5406	Oil Filter Full Flow.....	C-5402
Air Filter Primary.....	A-5618	<b>3984</b> (EXCAVATORS) D358		<b>433</b> (MOTOR GRADERS)	
Fuel Filter.....	F-7302	Fuel Filter.....	FC-5715	Air Filter Secondary.....	A-5114
Fuel Filter.....	F-6504	Hydraulic Oil Filter.....	H-5406	Air Filter Primary.....	A-6808
Oil Filter Full Flow.....	0-6503	<b>3984B</b> (EXCAVATORS) D358		Fuel Filter Secondary.....	FC-54050
<b>35</b> (DUMP TRUCKS) DETROIT DIESEL		Fuel Filter.....	FC-5715	Fuel Filter.....	FC-1810
Fuel Filter.....	F-6504	Hydraulic Oil Filter.....	H-5406	Fuel Filter.....	FC-7933
Hydraulic Oil Filter Transmission...	H-65030	<b>400</b> (DOZERS)		Fuel Filter.....	FC-5103
Oil Filter Full Flow.....	0-6503	Oil Filter Full Flow.....	C-1914	Fuel/Water Separator.....	SFC-5705
<b>35</b> (DUMP TRUCKS) NT-380					
Fuel Filter.....	FC-5720				
Fuel Filter.....	FC-1303				

# Sakura Filter

# ENGINE APPLICATION

MODEL/APPLICATION	SAKURA NO	MODEL/APPLICATION	SAKURA NO	MODEL/APPLICATION	SAKURA NO
<b>KOMATSU</b>		<b>KOMATSU</b>		<b>KOMATSU</b>	
<b>433</b> (MOTOR GRADERS)		Fuel Filter.....	F-6505	Oil Filter Full Flow.....	O-5702
Oil Filter Full Flow.....	C-1122	Fuel Filter.....	F-6503	Oil Filter Full Flow.....	C-8031
Oil Filter Full Flow.....	C-5402	Oil Filter Full Flow.....	O-6503		
<b>434</b> (LOADERS) 1961		<b>444</b> (MOTOR GRADERS) N-855C		<b>500C</b> (DOZERS)	
Fuel Filter.....	FC-5103	Coolant Filter.....	WC-5705	Fuel Filter.....	FC-5715
Oil Filter Full Flow.....	O-1803	Fuel Filter.....	FC-5702	Fuel Filter.....	FC-5103
		Oil Filter By Pass.....	O-5704	Oil Filter Full Flow.....	C-1914
<b>434</b> (LOADERS)		Oil Filter Full Flow.....	C-5715	Oil Filter Full Flow.....	C-5814
Fuel Filter.....	FC-5103	Oil Filter Full Flow.....	O-5702		
Oil Filter Full Flow.....	O-1803			<b>505</b> (LOADERS) 4D92	
		<b>444</b> (MOTOR GRADERS)		Fuel Filter.....	FC-5604
<b>435</b> (TRACTORS)		Fuel Filter.....	FC-7933	Hydraulic Oil Filter.....	H-5618
Oil Filter Full Flow.....	O-7901	Fuel Filter Secondary.....	FC-54050	Oil Filter Full Flow.....	C-5606
Oil Filter Full Flow.....	O-1803	Fuel Filter.....	FC-1810		
		Fuel/Water Separator.....	SFC-5705	<b>510</b> (LOADERS) 4D92	
<b>440</b> (MOTOR GRADERS) CUMMINS		Oil Filter Full Flow.....	C-5402	Air Filter Set.....	A-5655-S
Fuel Filter.....	FC-5720			Air Filter Secondary.....	A-5617
Fuel Filter.....	F-5701	<b>445E</b> (DUMP TRUCKS) KTA38		Air Filter Primary.....	A-5616
Fuel Filter.....	FC-1303	Fuel Filter.....	FC-5703	Fuel Filter.....	FC-5605
Fuel/Water Separator.....	SFC-5705	Fuel/Water Separator.....	SFC-5601-02	Hydraulic Oil Filter.....	H-5618
Hydraulic Oil Filter Transmission...	H-65030	Fuel/Water Separator.....	SFC-5707	Oil Filter Full Flow.....	C-5606
Oil Filter Full Flow.....	O-6503	Oil Filter By Pass.....	O-5704	Oil Filter Full Flow.....	C-6203
Oil Filter Full Flow.....	C-8031				
Oil Filter Full Flow.....	O-5702	<b>495</b> (MOTOR GRADERS) DT817		<b>510</b> (LOADERS) KTA38	
		Air Filter.....	A-8545	Fuel Filter.....	FC-5703
<b>440</b> (MOTOR GRADERS) DETROIT DIESEL		Hydraulic Oil Filter Transmission...	H-65030	Fuel/Water Separator.....	SFC-5601-02
Fuel Filter.....	F-6503			Fuel/Water Separator.....	SFC-5707
Fuel Filter Secondary.....	F-6502	<b>500</b> (DOZERS) D155		Oil Filter Full Flow.....	C-5701
Fuel Filter.....	F-6505	Air Filter Primary.....	AS-1014	Oil Filter Full Flow.....	C-5715
Oil Filter Full Flow.....	O-6503			Oil Filter Full Flow.....	C-5605
		<b>500</b> (DOZERS) D348			
<b>440H</b> (MOTOR GRADERS) CUMMINS		Air Filter Primary.....	AS-1014	<b>510</b> (LOADERS)	
Fuel Filter.....	FC-5720			Air Filter Primary.....	AS-5628
Fuel Filter.....	F-5701	<b>500</b> (DOZERS) DIESEL		Air Filter Primary.....	AS-7805
Fuel Filter.....	FC-1303	Fuel Filter.....	FC-5103	Air Filter Primary.....	A-6207
Fuel/Water Separator.....	SFC-5705	Oil Filter Full Flow.....	C-1914	Air Filter Primary.....	A-5628
Hydraulic Oil Filter Transmission...	H-65030			Air Filter Set.....	A-5628-S
Oil Filter Full Flow.....	O-6503	<b>500E</b> (LOADERS) D155		Air Filter Secondary.....	A-6302
Oil Filter Full Flow.....	C-8031	Fuel Filter.....	FC-5103		
Oil Filter Full Flow.....	O-5702	Oil Filter Full Flow.....	C-1914	<b>510B</b> (LOADERS) D240T	
		Oil Filter Full Flow.....	C-5814	Air Filter Primary.....	AS-7805
<b>440H</b> (MOTOR GRADERS) DETROIT DIESEL				Air Filter Secondary.....	A-7806
Fuel Filter.....	F-6503	<b>50</b> (DUMP TRUCKS) 12V-71		Fuel Filter Secondary.....	FC-7903
Fuel Filter.....	F-6505	Air Filter.....	A-85400	Fuel/Water Separator.....	SFC-5708
Fuel Filter Secondary.....	F-6502	Fuel Filter.....	F-6504	Fuel/Water Separator.....	SFC-5706
Oil Filter Full Flow.....	O-6503	Oil Filter Full Flow.....	O-6503	Oil Filter Full Flow.....	C-5703
				Oil Filter Full Flow.....	C-5730
<b>442</b> (MOTOR GRADERS)		<b>50</b> (DUMP TRUCKS) 14BD264			
Fuel Filter Secondary.....	FC-54050	Air Filter.....	A-85400	<b>510C</b> (LOADERS) D240T	
Fuel/Water Separator.....	SFC-5705	Fuel Filter.....	F-6504	Air Filter Primary.....	AS-7805
Hydraulic Oil Filter.....	H-5406	Oil Filter Full Flow.....	O-6503	Air Filter Secondary.....	A-7806
Oil Filter Full Flow.....	C-5402			Fuel Filter Secondary.....	FC-7903
		<b>50</b> (DUMP TRUCKS) VT-1710		Fuel/Water Separator.....	SFC-5708
<b>444</b> (MOTOR GRADERS) 4-71N		Air Filter.....	A-85400	Fuel/Water Separator.....	SFC-5706
Fuel Filter Secondary.....	F-6502	Fuel Filter.....	F-5701	Oil Filter Full Flow.....	C-5730
				Oil Filter Full Flow.....	C-5703



# Sakura Filter

# ENGINE APPLICATION

MODEL/APPLICATION	SAKURA NO	MODEL/APPLICATION	SAKURA NO	MODEL/APPLICATION	SAKURA NO
<b>KOMATSU</b>		<b>KOMATSU</b>		<b>KOMATSU</b>	
<b>510E</b> (DUMP TRUCKS) 12V-149T1B		Oil Filter Full Flow.....	C-5730	<b>540</b> (LOADERS) SA6D110-1	
Fuel Filter.....	FC-6506	<b>520EH</b> (LOADERS) S6D102E-1/46082941		Air Filter Secondary.....	A-5406
Fuel Filter.....	FC-6505	Air Filter Secondary.....	A-5667	Air Filter.....	A-5434
Oil Filter Full Flow.....	C-5731	Air Filter Primary.....	A-5666	Fuel Filter.....	FC-5602
Oil Filter Full Flow.....	C-7005	<b>523</b> (LOADERS)		Hydraulic Oil Filter.....	H-5618
<b>510E</b> (DUMP TRUCKS) KTTA-38C		Fuel Filter.....	F-2603	Oil Filter Full Flow.....	C-5614
Oil Filter Full Flow.....	C-5715	Oil Filter Full Flow.....	C-1122	<b>550</b> (MOTOR GRADERS) CUMMINS	
Oil Filter By Pass.....	C-5718	<b>523A</b> (LOADERS)		Fuel Filter.....	FC-1303
<b>515</b> (LOADERS) DA220		Fuel Filter.....	F-2603	Fuel Filter.....	FC-5720
Fuel Filter.....	F-1303	Oil Filter Full Flow.....	C-1122	Fuel Filter.....	F-5701
<b>515</b> (LOADERS)		<b>530</b> (LOADERS)		Fuel/Water Separator.....	SFC-5705
Fuel Filter.....	FC-7933	Air Filter Primary.....	A-5413	Hydraulic Oil Filter Transmission...	H-65030
Fuel/Water Separator.....	SFC-5705	Air Filter Secondary.....	A-6302	Oil Filter Full Flow.....	O-6503
<b>515B</b> (LOADERS)		Air Filter Primary.....	A-6207	Oil Filter Full Flow.....	C-8031
Fuel Filter.....	FC-5403	Air Filter Secondary.....	A-5414	Oil Filter Full Flow.....	O-5702
Hydraulic Oil Filter.....	H-5406	Air Filter Set.....	A-5660-S	<b>550</b> (MOTOR GRADERS) DETROIT DIESEL	
<b>515C</b> (LOADERS) D358		Fuel Filter.....	FC-7933	Fuel Filter.....	F-6503
Air Filter Secondary.....	A-7964	Fuel/Water Separator.....	SFC-5705	Fuel Filter.....	F-6505
Fuel Filter.....	F-2604	<b>515B</b> (LOADERS)		Fuel Filter Secondary.....	F-6502
Fuel Filter.....	FC-5103	Fuel Filter.....	FC-5403	Oil Filter Full Flow.....	O-6503
Hydraulic Oil Filter.....	HC-5402	Hydraulic Oil Filter.....	H-5406	<b>550</b> (MOTOR GRADERS)	
<b>520</b> (LOADERS)		<b>530</b> (LOADERS) S6D105		Air Filter Primary.....	A-5420
Air Filter Secondary.....	A-6302	Air Filter Primary.....	A-5413	Air Filter Set.....	A-5420-S
Air Filter Primary.....	A-6207	Air Filter Secondary.....	A-5414	Coolant Filter.....	WC-5705
<b>520B</b> (LOADERS) D359T		Air Filter Set.....	A-5660-S	Fuel Filter Secondary.....	FC-54050
Air Filter Set.....	A-5662-S	Coolant Filter.....	WC-5707	Fuel/Water Separator.....	SFC-5705
Air Filter Primary.....	A-1313	Hydraulic Oil Filter.....	H-5618	Oil Filter Full Flow.....	C-5402
Air Filter Secondary.....	A-1307	Oil Filter Full Flow.....	C-5614	<b>55</b> (MOTOR GRADERS) HR-6	
Fuel Filter Secondary.....	FC-7903	<b>530A</b> (LOADERS)		Fuel Filter.....	FC-1303
Fuel/Water Separator.....	SFC-5706	Air Filter Secondary.....	A-6302	Fuel Filter.....	FC-5720
Fuel/Water Separator.....	SFC-5708	Air Filter Primary.....	A-6207	Fuel/Water Separator.....	SFC-5705
Oil Filter Full Flow.....	C-5730	Fuel Filter.....	FC-5403	<b>555</b> (MOTOR GRADERS) 6-71N	
<b>520C</b> (LOADERS) D359T		<b>530E</b> (DUMP TRUCKS) KTA50		Fuel Filter.....	F-6505
Air Filter Primary.....	A-1313	Fuel Filter.....	FC-5703	Fuel Filter.....	F-6503
Air Filter Set.....	A-5662-S	Fuel/Water Separator.....	SFC-5707	Oil Filter Full Flow.....	O-6503
Air Filter Secondary.....	A-1307	Fuel/Water Separator.....	SFC-5601-02	<b>555</b> (MOTOR GRADERS) N-855C	
Fuel Filter Secondary.....	FC-7903	Oil Filter Full Flow.....	C-5605	Coolant Filter.....	WC-5705
Fuel/Water Separator.....	SFC-5706	Oil Filter Full Flow.....	C-5701	Fuel Filter.....	FC-5702
Fuel/Water Separator.....	SFC-5706	Oil Filter Full Flow.....	C-5715	Oil Filter By Pass.....	O-5704
Oil Filter Full Flow.....	C-5730	Oil Filter By Pass.....	O-5704	Oil Filter Full Flow.....	O-5702
<b>520CH</b> (LOADERS) D359T		Oil Filter By Pass.....	O-5704	Oil Filter Full Flow.....	C-5715
Air Filter Set.....	A-5662-S	<b>530M</b> (DUMP TRUCKS) KTA50		<b>560</b> (LOADERS) KT-1150	
Air Filter Primary.....	A-1313	Fuel Filter.....	FC-5703	Coolant Filter.....	WC-5705
Air Filter Secondary.....	A-1307	Fuel/Water Separator.....	SFC-5707	Fuel Filter.....	FC-5702
Fuel Filter Secondary.....	FC-7903	Fuel/Water Separator.....	SFC-5601-02	Oil Filter By Pass.....	C-5718
Fuel/Water Separator.....	SFC-5706	Oil Filter Full Flow.....	C-5715	Oil Filter Full Flow.....	C-5715
Fuel/Water Separator.....	SFC-5706	Oil Filter Full Flow.....	C-5605	<b>560</b> (LOADERS)	
Fuel/Water Separator.....	SFC-5708	Oil Filter By Pass.....	O-5704	Fuel Filter.....	FC-54050
<b>520CH</b> (LOADERS) D359T		Oil Filter Full Flow.....	C-5701	<b>560</b> (LOADERS)	
Air Filter Set.....	A-5662-S	<b>540</b> (LOADERS) 3D94-2		Fuel Filter Secondary.....	FC-54050
Air Filter Primary.....	A-1313	Fuel/Water Separator.....	SFC-5705		
Air Filter Secondary.....	A-1307				
Fuel Filter Secondary.....	FC-7903				
Fuel/Water Separator.....	SFC-5706				
Fuel/Water Separator.....	SFC-5708				

# Sakura Filter

# ENGINE APPLICATION

MODEL/APPLICATION	SAKURA NO	MODEL/APPLICATION	SAKURA NO	MODEL/APPLICATION	SAKURA NO
<b>KOMATSU</b>		<b>KOMATSU</b>		<b>KOMATSU</b>	
<b>560</b> (LOADERS)		<b>60N-1</b> (EXCAVATORS) 4D94-2		Fuel Filter.....	FC-1303
Fuel Filter.....	FC-5403	Fuel Filter.....	FC-5604	Fuel Filter.....	FC-5720
Fuel/Water Separator.....	SFC-5705	Hydraulic Oil Filter.....	H-5607	Fuel/Water Separator.....	SFC-5705
Oil Filter Full Flow.....	C-5402	Oil Filter Full Flow.....	C-5606		
<b>560B</b> (LOADERS) KT-1150		<b>60U-1</b> (EXCAVATORS) 4D94-2D		<b>75B</b> (LOADERS) 16V-71T	
Coolant Filter.....	WC-5705	Air Filter Primary.....	AS-1014	Fuel Filter.....	F-6504
Fuel Filter.....	FC-5702	Fuel Filter.....	FC-5604	Oil Filter Full Flow.....	O-6503
Oil Filter Full Flow.....	C-5715	Hydraulic Oil Filter.....	H-5607		
Oil Filter By Pass.....	C-5718	Oil Filter Full Flow.....	C-5606	<b>75B</b> (LOADERS) VTA-1710	
<b>60</b> (DUMP TRUCKS) 12V-71		<b>60U-2</b> (EXCAVATORS) 4D94-2D		Coolant Filter.....	WC-5705
Air Filter.....	A-85400	Air Filter Primary.....	AS-1014	Fuel Filter.....	FC-5703
Fuel Filter.....	F-6504	Fuel Filter.....	FC-5604	Fuel/Water Separator.....	SFC-5707
Oil Filter Full Flow.....	O-6503	Hydraulic Oil Filter.....	H-5607	Oil Filter Full Flow.....	C-5715
<b>60</b> (DUMP TRUCKS) 14BD264		<b>650R-3</b> (MOTOR GRADERS) S/N: 24001		Oil Filter By Pass.....	O-5704
Air Filter.....	A-85400	Air Filter Primary.....	A-5605		
Fuel Filter.....	F-6504	Air Filter Secondary.....	A-5606	<b>777</b> (MOTOR GRADERS) CUMMINS	
Oil Filter Full Flow.....	O-6503	Air Filter Set.....	A-5604-S	Fuel Filter.....	FC-1303
<b>60</b> (DUMP TRUCKS) VT-1710		Fuel Filter.....	FC-5602	Fuel Filter.....	FC-5720
Air Filter.....	A-85400	Hydraulic Oil Filter.....	H-5620	Fuel Filter.....	FC-5701
Fuel Filter.....	F-5701	Oil Filter Full Flow.....	C-5614	Fuel/Water Separator.....	SFC-5705
Oil Filter Full Flow.....	C-8031	<b>655-3</b> (MOTOR GRADERS) 34001		Hydraulic Oil Filter Transmission...	H-65030
Oil Filter Full Flow.....	O-5702	Air Filter Primary.....	A-5605	Oil Filter Full Flow.....	O-5702
<b>600SD1-C</b> (DOZERS)		Air Filter Set.....	A-5604-S	Oil Filter Full Flow.....	C-8031
Fuel Filter.....	F-7302	Air Filter Secondary.....	A-5606	Oil Filter Full Flow.....	O-6503
Fuel Filter.....	F-6503	Fuel Filter.....	FC-5602		
Oil Filter Full Flow.....	O-6503	Hydraulic Oil Filter.....	H-5620	<b>777</b> (MOTOR GRADERS) DETROIT DIESEL	
<b>60-1</b> (EXCAVATORS) 4D94-2D		Oil Filter Full Flow.....	C-5614	Fuel Filter.....	F-6503
Air Filter Primary.....	AS-1014	<b>666</b> (MOTOR GRADERS) CUMMINS		Fuel Filter.....	F-6505
Fuel Filter.....	FC-5604	Fuel Filter.....	FC-5720	Fuel Filter Secondary.....	F-6502
Hydraulic Oil Filter.....	H-5607	Fuel Filter.....	F-5701	Oil Filter Full Flow.....	O-6503
Oil Filter Full Flow.....	C-5606	Fuel Filter.....	FC-1303		
<b>60L</b> (EXCAVATORS) 4D94-2D		Fuel/Water Separator.....	SFC-5705	<b>830C</b> (MOTOR GRADERS) 6BT5.9	
Air Filter Primary.....	AS-1014	Hydraulic Oil Filter Transmission...	H-65030	Fuel Filter Secondary.....	FC-7903
Fuel Filter.....	FC-5604	Oil Filter Full Flow.....	O-5702	Fuel/Water Separator.....	SFC-5706
Hydraulic Oil Filter.....	H-5607	Oil Filter Full Flow.....	C-8031	Fuel/Water Separator.....	SFC-5708
Oil Filter Full Flow.....	C-5606	Oil Filter Full Flow.....	O-6503	Oil Filter Full Flow.....	C-5730
<b>60L-1</b> (EXCAVATORS) 4D94-2D		<b>666</b> (MOTOR GRADERS) DETROIT DIESEL		<b>830C</b> (MOTOR GRADERS) D359T	
Air Filter Primary.....	AS-1014	Fuel Filter.....	F-6505	Air Filter Primary.....	A-7615
Fuel Filter.....	FC-5604	Fuel Filter.....	F-6503	Air Filter Secondary.....	A-7614
Hydraulic Oil Filter.....	H-5607	Fuel Filter Secondary.....	F-6502	Air Filter Set.....	A-7615-S
Oil Filter Full Flow.....	C-5606	Oil Filter Full Flow.....	O-6503	Fuel Filter Secondary.....	FC-7903
<b>60L-2</b> (EXCAVATORS) 4D94-2D		<b>730E</b> (DUMP TRUCKS) SSA16V159		Fuel/Water Separator.....	SFC-5708
Air Filter Primary.....	AS-1014	Air Filter Secondary.....	A-7902	Fuel/Water Separator.....	SFC-5706
Fuel Filter.....	FC-5604	Fuel/Water Separator.....	SFC-5601-02	Hydraulic Oil Filter.....	HC-76080
Hydraulic Oil Filter.....	H-5607	Oil Filter Full Flow.....	C-5701	Oil Filter Full Flow.....	C-5730
Oil Filter Full Flow.....	C-5606	Oil Filter Full Flow.....	C-5605		
<b>75</b> (MOTOR GRADERS) NT-6				<b>830B</b> (MOTOR GRADERS) D359T	
				Fuel Filter Secondary.....	FC-7903
				Fuel/Water Separator.....	SFC-5708
				Fuel/Water Separator.....	SFC-5706
				Oil Filter Full Flow.....	C-5730

MODEL/APPLICATION	SAKURA NO	MODEL/APPLICATION	SAKURA NO	MODEL/APPLICATION	SAKURA NO
<b>KOMATSU</b>		<b>KOMATSU</b>		<b>KOMATSU</b>	
<b>830B</b> (MOTOR GRADERS) D359T		Fuel Filter Secondary.....	FC-7903	Fuel/Water Separator.....	SFC-5708
Fuel/Water Separator.....	SFC-5708	Fuel/Water Separator.....	SFC-5706	Fuel/Water Separator.....	SFC-5706
Fuel/Water Separator.....	SFC-5706	Fuel/Water Separator.....	SFC-5708	Hydraulic Oil Filter.....	HC-76080
Hydraulic Oil Filter.....	HC-76080	Oil Filter Combination.....	C-5723	Oil Filter Combination.....	C-7927
Oil Filter Full Flow.....	C-5730			Oil Filter Full Flow.....	C-1305
<b>830E</b> (DUMP TRUCKS) 16V-149		<b>850B</b> (MOTOR GRADERS) D505T		<b>870C</b> (MOTOR GRADERS) 6CT8.3	
Air Filter Secondary.....	A-9205	Air Filter Set.....	A-7615-S	Fuel Filter Secondary.....	FC-7903
Fuel Filter.....	FC-6506	Air Filter Primary.....	A-7615	Fuel/Water Separator.....	SFC-5708
Fuel Filter.....	FC-6505	Air Filter Secondary.....	A-7614	Fuel/Water Separator.....	SFC-5706
Fuel/Water Separator.....	SFC-5601-02	Fuel Filter Secondary.....	FC-7903	Oil Filter Combination.....	C-5723
Oil Filter Full Flow.....	C-7005	Fuel/Water Separator.....	SFC-5708		
Oil Filter Full Flow.....	C-5731	Fuel/Water Separator.....	SFC-5706	<b>870C</b> (MOTOR GRADERS) D505T	
		Hydraulic Oil Filter.....	HC-76080	Air Filter Set.....	A-7615-S
<b>830E</b> (DUMP TRUCKS) CUMMINS QSK60/HPI		Oil Filter Combination.....	C-7927	Air Filter Secondary.....	A-7614
Cabin Air Filter Recirculation.....	CA-56140	Oil Filter Full Flow.....	C-1305	Air Filter Primary.....	A-7615
<b>830E</b> (DUMP TRUCKS) DETROITD 16V-149		<b>850C</b> (MOTOR GRADERS) 6CT8.3		Fuel Filter Secondary.....	FC-7903
Cabin Air Filter Recirculation.....	CA-56140	Fuel Filter Secondary.....	FC-7903	Fuel/Water Separator.....	SFC-5708
<b>830E</b> (DUMP TRUCKS) DETROITD 16V4000		Fuel/Water Separator.....	SFC-5708	Fuel/Water Separator.....	SFC-5706
Cabin Air Filter Recirculation.....	CA-56140	Fuel/Water Separator.....	SFC-5706	Hydraulic Oil Filter.....	HC-76080
<b>830E-AC</b> (DUMP TRUCKS)		Oil Filter Combination.....	C-5723	Oil Filter Combination.....	C-7927
Cabin Air Filter Recirculation.....	CA-56140			Oil Filter Full Flow.....	C-1305
<b>830E-AC</b> (DUMP TRUCKS) SDA16V160		<b>850C</b> (MOTOR GRADERS) D505T		<b>888</b> (MOTOR GRADERS) 8V-71	
Air Filter Secondary.....	A-9205	Air Filter Set.....	A-7615-S	Fuel Filter.....	F-7302
<b>830E-15</b> (DUMP TRUCKS) DETROITD 16V-149		Air Filter Primary.....	A-7615	Fuel Filter.....	F-6503
Cabin Air Filter Recirculation.....	CA-56140	Air Filter Secondary.....	A-7614	Fuel Filter.....	F-6504
<b>830E-15</b> (DUMP TRUCKS) DETROITD 16V4000		Fuel Filter Secondary.....	FC-7903	Fuel Filter.....	F-6505
Cabin Air Filter Recirculation.....	CA-56140	Fuel/Water Separator.....	SFC-5706	Oil Filter Full Flow.....	O-6503
<b>830E-1AC</b> (DUMP TRUCKS)		Fuel/Water Separator.....	SFC-5708		
Cabin Air Filter Recirculation.....	CA-56140	Hydraulic Oil Filter.....	HC-76080	<b>8G2</b> (LOADERS) 1965	
<b>844</b> (TRACTORS) 310		Oil Filter Combination.....	C-7927	Fuel Filter.....	FC-5103
Fuel Filter.....	FC-5103	Oil Filter Full Flow.....	C-1305	<b>930E - 2</b> (DUMP TRUCKS) QSK60	
<b>844</b> (TRACTORS)		<b>850RL</b> (MOTOR GRADERS) CUMMINS		Fuel/Water Separator.....	SFC-5601-02
Air Filter Secondary.....	A-5309	Coolant Filter.....	WC-5705	<b>930E-4SE</b> (DUMP TRUCKS) QSK78 , 2011	
Air Filter Primary.....	A-6201	Fuel Filter Secondary.....	FC-7903	Fuel/Water Separator.....	SFC-5601-02
Fuel Filter.....	F-2603	Fuel/Water Separator.....	SFC-5706		
Fuel Filter.....	FC-5103	Fuel/Water Separator.....	SFC-5708	<b>B100</b> (LOADERS)	
<b>844SB</b> (TRACTORS)		Oil Filter Combination.....	C-5723	Fuel Filter.....	FC-5103
Air Filter Primary.....	A-6808	<b>860E</b> (DUMP TRUCKS) 2009		Hydraulic Oil Filter.....	H-55270
Air Filter Secondary.....	A-5114	Air Filter Primary.....	A-44310	Hydraulic Oil Filter.....	H-5504
Fuel Filter.....	FC-5103	Air Filter Secondary.....	A-44320		
Oil Filter Full Flow.....	C-6204	<b>860E</b> (DUMP TRUCKS)		<b>B125</b> (LOADERS)	
<b>850B</b> (MOTOR GRADERS) 6CT8.3		Air Filter Set.....	A-44310-S	Air Filter Set.....	A-5628-S
		<b>870B</b> (MOTOR GRADERS) 6CT8.3		Air Filter Primary.....	AS-5628
		Fuel Filter Secondary.....	FC-7903	Air Filter Primary.....	A-5628
		Fuel/Water Separator.....	SFC-5708	Fuel Filter.....	FC-5103
		Fuel/Water Separator.....	SFC-5706	Oil Filter Full Flow.....	O-6503
		Oil Filter Combination.....	C-5723		
		<b>870B</b> (MOTOR GRADERS) D505T		<b>B250 LITTLE GIANT</b> (LOADERS)	
		Air Filter Primary.....	A-7615	Fuel Filter.....	FC-5103
		Air Filter Set.....	A-7615-S	Oil Filter Full Flow.....	O-1803
		Air Filter Secondary.....	A-7614		
		Fuel Filter Secondary.....	FC-7903	<b>B275</b> (LOADERS)	
				Fuel Filter.....	FC-5103

# Sakura Filter

# ENGINE APPLICATION

MODEL/APPLICATION	SAKURA NO	MODEL/APPLICATION	SAKURA NO	MODEL/APPLICATION	SAKURA NO
<b>KOMATSU</b>		<b>KOMATSU</b>		<b>KOMATSU</b>	
<b>B275</b> (LOADERS)		<b>BR200R-1</b> (CRUSHER) S6D95L		Air Filter Primary.....	A-6113
Oil Filter Full Flow.....	0-1803	Air Filter Secondary.....	A-6008	Fuel Filter.....	FC-5602
<b>B414</b> (LOADERS)		Air Filter Set.....	A-5663-S	Hydraulic Oil Filter.....	H-2709
Fuel Filter.....	FC-5103	Air Filter Primary.....	A-5627	Oil Filter Full Flow.....	C-5701
Oil Filter Full Flow.....	0-1803	Hydraulic Oil Filter.....	H-85680	Oil Filter Full Flow.....	C-5715
<b>B500</b> (LOADERS)		Hydraulic Oil Filter.....	H-7911	Oil Filter Full Flow.....	C-5605
Fuel Filter.....	FC-5103	Oil Filter Full Flow.....	C-5606	Oil Filter By Pass.....	C-5718
Oil Filter Full Flow.....	0-1803	<b>BR200S-1</b> (CRUSHER) S6D95L		<b>BR500JG-1A</b> (CRUSHER) SAA6D125E-2	
<b>B8K3</b> (LOADERS) 1965		Air Filter Primary.....	A-5627	Air Filter Primary.....	A-6113
Fuel Filter.....	FC-5103	Air Filter Secondary.....	A-6008	Fuel Filter.....	FC-5602
<b>BD414</b> (LOADERS) 1961		Air Filter Set.....	A-5663-S	Hydraulic Oil Filter.....	H-2709
Fuel Filter.....	FC-5103	Hydraulic Oil Filter.....	H-85680	Oil Filter Full Flow.....	C-5715
Oil Filter Full Flow.....	0-1803	Hydraulic Oil Filter.....	H-7911	Oil Filter Full Flow.....	C-5701
<b>BD5</b> (LOADERS)		Oil Filter Full Flow.....	C-5606	Oil Filter Full Flow.....	C-5605
Oil Filter Full Flow.....	0-1803	<b>BR300J-1</b> (CRUSHER) S/N: 1001		<b>BR580JG-1</b> (CRUSHER) SAA6D125E-5 , 2011	
<b>BF480RG-1</b> (CRUSHER) KOMATSU SAA6D125E-2		Air Filter Primary.....	A-5627	Fuel/Water Separator Secondary..	SFC-5611-10
Fuel Filter.....	FC-5610	Air Filter Set.....	A-5663-S	Fuel/Water Separator Secondary..	SFC-5611-10B
<b>BF480RG-1</b> (CRUSHER) SAA6D125E-2		Fuel Filter.....	FC-5621	<b>BR550JG-1</b> (CRUSHER) KOMATSU SAA6D125E-2	
Fuel Filter.....	FC-5602	Hydraulic Oil Filter.....	H-7911	Fuel Filter.....	FC-5610
Hydraulic Oil Filter.....	H-2709	Hydraulic Oil Filter.....	H-85680	<b>BR550JG-1</b> (CRUSHER) SAA6D125E-2	
Oil Filter Full Flow.....	C-5715	Oil Filter Full Flow.....	C-5606	Air Filter Secondary.....	A-5408
Oil Filter Full Flow.....	C-5605	<b>BR310JG-1</b> (CRUSHER) SAA6D95L		Fuel Filter.....	FC-5602
Oil Filter Full Flow.....	C-5701	Air Filter Secondary.....	A-6008	Hydraulic Oil Filter.....	H-2709
<b>BH25</b> (LOADERS)		Air Filter Primary.....	A-5627	Oil Filter Full Flow.....	C-5701
Fuel Filter.....	FC-5103	Air Filter Set.....	A-5663-S	Oil Filter Full Flow.....	C-5715
Oil Filter Full Flow.....	0-1803	Hydraulic Oil Filter.....	H-85680	Oil Filter Full Flow.....	C-5605
<b>BH25B</b> (LOADERS)		Hydraulic Oil Filter.....	H-7911	Oil Filter Full Flow.....	C-5701
Oil Filter Full Flow.....	0-2619	Oil Filter Full Flow.....	C-5606	<b>BTD125</b> (LOADERS)	
<b>BM2009C</b> (CRUSHER) 4D84E-3		<b>BR350JG-1</b> (CRUSHER) S/N: 1005		Air Filter Primary.....	AS-5628
Fuel Filter.....	F-5210	Air Filter Secondary.....	A-5635	Air Filter Primary.....	A-5628
Oil Filter Full Flow.....	C-8012	Air Filter Primary.....	A-5639	Air Filter Set.....	A-5628-S
Oil Filter Full Flow.....	C-1720	Fuel Filter Secondary.....	FC-7903	Fuel Filter.....	FC-5103
<b>BP500</b> (PILE DRIVERS) S6D105		Fuel/Water Separator.....	SFC-5708	Oil Filter Full Flow.....	0-6503
Oil Filter Full Flow.....	C-5614	Hydraulic Oil Filter.....	H-85680	<b>BTD20</b> (LOADERS) 1965	
<b>BR200J-1</b> (CRUSHER) S6D95L		Oil Filter Full Flow.....	C-5730	Fuel Filter.....	FC-5103
Air Filter Set.....	A-5663-S	<b>BR380JG-1E0</b> (CRUSHER) SAA6D107E-1 , 2011		<b>BTD8</b> (LOADERS) 1965	
Air Filter Secondary.....	A-6008	Air Filter Primary.....	A-5558M	Fuel Filter.....	FC-5103
Air Filter Primary.....	A-5627	Air Filter Secondary.....	A-5559	<b>CC2000</b> (CRANES) BF12L413F	
Hydraulic Oil Filter.....	H-85680	Air Filter Set.....	A-5558M-S	Oil Filter Full Flow.....	C-6204
Hydraulic Oil Filter.....	H-7911	Hydraulic Oil Filter.....	H-5646	<b>CC280</b> (CRANES) F6/8L413	
Oil Filter Full Flow.....	C-5606	Hydraulic Oil Filter.....	H-5629	Fuel Filter.....	F-2603
<b>BR200J-1</b> (CRUSHER) S6D95L		Oil Filter Full Flow.....	C-5611	Fuel Filter.....	FC-5704
Air Filter Set.....	A-5663-S	<b>BR380JG-1E0</b> (CRUSHER) SAA6D107E-1		Oil Filter Full Flow.....	C-6204
Air Filter Secondary.....	A-6008	Fuel Filter.....	FC-5613	Oil Filter Full Flow.....	C-6203
Air Filter Primary.....	A-5627	<b>BR380JG-1</b> (CRUSHER) SAA6D107E-1		<b>CC300</b> (CRANES) F8L413F	
Hydraulic Oil Filter.....	H-85680	Fuel Filter.....	FC-5613	Fuel Filter.....	FC-5704
Hydraulic Oil Filter.....	H-7911	<b>BR500JG-1</b> (CRUSHER) SAA6D125E-2		Oil Filter Full Flow.....	C-6204
Oil Filter Full Flow.....	C-5606	Air Filter Secondary.....	A-5408	Oil Filter Full Flow.....	C-6203

MODEL/APPLICATION	SAKURA NO	MODEL/APPLICATION	SAKURA NO	MODEL/APPLICATION	SAKURA NO
<b>KOMATSU</b>		<b>KOMATSU</b>		<b>KOMATSU</b>	
<b>CC4000</b> (CRANES) VT-903		<b>D100</b> (DOZERS) NT-855		Fuel Filter.....	F-6503
Coolant Filter.....	WC-5705	Air Filter.....	AS-5706	Fuel Filter.....	F-7302
Fuel Filter.....	FC-5702	Fuel Filter.....	F-5701	Oil Filter Full Flow.....	O-6503
Oil Filter Full Flow.....	C-5715	Fuel Filter.....	FC-5720		
Oil Filter By Pass.....	C-5718	Fuel Filter.....	FC-1303	<b>D120 SERIES C</b> (DOZERS) DT817	
		Fuel/Water Separator.....	SFC-5705	Hydraulic Oil Filter Transmission...	H-65030
<b>CC600</b> (CRANES) F8L413F		Hydraulic Oil Filter Transmission...	H-65030		
Fuel Filter.....	FC-5704	Oil Filter Full Flow.....	O-5702	<b>D120A-18</b> (DOZERS) NRTO-6C1	
Oil Filter Full Flow.....	C-6203			Fuel Filter.....	F-5601
Oil Filter Full Flow.....	C-6204	<b>D100 SERIES B</b> (DOZERS) IHC		Oil Filter Full Flow.....	O-5603
		Fuel Filter Secondary.....	FC-54050	Oil Filter By Pass.....	O-5704
<b>CD110R-2</b> (CARRIERS) KOMATSU SAA6D114E-2		Fuel/Water Separator.....	SFC-5705		
Fuel Filter.....	FC-5610	Hydraulic Oil Filter Transmission...	H-65030	<b>D125</b> (DOZERS) CUMMINS	
		Oil Filter Full Flow.....	C-5402	Coolant Filter.....	WC-5711
<b>CD110R-2</b> (CARRIERS) SAA6D114E-2		<b>D105-2</b> (LOADERS) 2D92		Fuel Filter.....	F-5601
Air Filter Set.....	A-5558M-S	Oil Filter Full Flow.....	C-5606	Oil Filter By Pass.....	O-5704
Air Filter Primary.....	A-5558M			Oil Filter Full Flow.....	C-2302
Air Filter Secondary.....	A-5559	<b>D-1100</b> (MOTOR GRADERS) CUMMINS			
Hydraulic Oil Filter.....	H-5618	Fuel Filter.....	F-5701	<b>D125A</b> (DOZERS) CUMMINS	
		Hydraulic Oil Filter Transmission...	H-65030	Coolant Filter.....	WC-5711
<b>CK20-1</b> (LOADERS) S4D98E		Oil Filter Full Flow.....	O-5702	Fuel Filter.....	F-5601
Air Filter Secondary.....	A-7004			Oil Filter By Pass.....	O-5704
Air Filter Primary.....	A-8506	<b>D12</b> (DOZERS) CUMMINS		Oil Filter Full Flow.....	C-2302
Air Filter Set.....	A-8506-S	Air Filter Primary.....	A-5636		
Fuel Filter.....	FC-5201	Fuel Filter.....	F-5601	<b>D125A-18</b> (DOZERS) NRTO-6C1	
		Hydraulic Oil Filter.....	H-55270	Fuel Filter.....	F-5601
<b>CK30-1</b> (LOADERS) S4D98E		Hydraulic Oil Filter.....	H-5504	Oil Filter Full Flow.....	O-5603
Air Filter Set.....	A-8506-S	Hydraulic Oil Filter.....	H-5610	Oil Filter By Pass.....	O-5704
Air Filter Primary.....	A-8506	Hydraulic Oil Filter.....	H-56600		
Air Filter Secondary.....	A-7004	Oil Filter Full Flow.....	O-5603	<b>D135A-1</b> (DOZERS) SA6D125	
Fuel Filter.....	FC-5201	Oil Filter By Pass.....	O-5704	Fuel Filter.....	FC-5606
				<b>D135A-1</b> (DOZERS) SA6D125-1/10001	
<b>CK35-1</b> (LOADERS) S4D98E		<b>D120</b> (DOZERS) 8V-71		Air Filter Secondary.....	A-5408
Air Filter Secondary.....	A-7004	Fuel Filter.....	F-7302	Fuel Filter.....	FC-5602
Air Filter Set.....	A-8506-S	Fuel Filter.....	F-6503	Hydraulic Oil Filter.....	H-5606
Air Filter Primary.....	A-8506	Oil Filter Full Flow.....	O-6503	Hydraulic Oil Filter.....	H-5610
Oil Filter Full Flow.....	C-8012			Hydraulic Oil Filter.....	H-56600
		<b>D120</b> (DOZERS) DT817		Oil Filter Full Flow.....	C-5701
<b>D100</b> (DOZERS) 6V-71		Hydraulic Oil Filter Transmission...	H-65030	Oil Filter Full Flow.....	C-5605
Fuel Filter.....	F-6503			Oil Filter Full Flow.....	C-5715
Fuel Filter.....	F-6504	<b>D120</b> (DOZERS) DT817B			
Fuel Filter.....	F-7302	Fuel Filter Secondary.....	FC-54050	<b>D135A-2</b> (DOZERS) KOMATSU S6D140	
Fuel Filter.....	F-6505	Fuel/Water Separator.....	SFC-5705	Hydraulic Oil Filter Transmission...	H-56570
Oil Filter Full Flow.....	O-6503	Hydraulic Oil Filter Transmission...	H-65030		
				<b>D135A-2</b> (DOZERS) S6D140-1/10301	
<b>D100</b> (DOZERS) IHC		<b>D120 SERIES B</b> (DOZERS) 8V-71		Air Filter Secondary.....	A-5610
Fuel Filter Secondary.....	FC-54050	Fuel Filter.....	F-7302	Air Filter Primary.....	A-5614
Fuel/Water Separator.....	SFC-5705	Fuel Filter.....	F-6503	Fuel Filter.....	FC-5602
Hydraulic Oil Filter Transmission...	H-65030	Oil Filter Full Flow.....	O-6503	Hydraulic Oil Filter.....	H-5610
Oil Filter Full Flow.....	C-5402			Hydraulic Oil Filter.....	H-56600
		<b>D120 SERIES B</b> (DOZERS) DT817		Hydraulic Oil Filter.....	H-5606
<b>D100</b> (DOZERS) NH220		Hydraulic Oil Filter Transmission...	H-65030	Oil Filter Full Flow.....	C-5715
Fuel Filter.....	F-5701			Oil Filter Full Flow.....	C-5701
Hydraulic Oil Filter Transmission...	H-65030	<b>D120 SERIES C</b> (DOZERS) 8V-71		Oil Filter Full Flow.....	C-5605
Oil Filter Full Flow.....	O-5702				

MODEL/APPLICATION	SAKURA NO	MODEL/APPLICATION	SAKURA NO	MODEL/APPLICATION	SAKURA NO
<b>KOMATSU</b>		<b>KOMATSU</b>		<b>KOMATSU</b>	
<b>D135A-2</b> (DOZERS) S6D140		Air Filter Primary.....	A-5614	Air Filter Primary.....	A-5614
Fuel Filter.....	FC-5606	Fuel Filter.....	FC-5602	Air Filter Primary.....	A-8665M
<b>D150A-1</b> (DOZERS) S6D155		Hydraulic Oil Filter.....	H-56600	Cabin Air Filter.....	CA-5602
Air Filter Secondary.....	A-5610	Hydraulic Oil Filter.....	H-5610	Fuel Filter.....	FC-5703
Air Filter Primary.....	A-5614	Hydraulic Oil Filter.....	H-5606	Fuel/Water Separator.....	SFC-5707
Fuel Filter.....	FC-5606	Oil Filter Full Flow.....	C-5715	Oil Filter Full Flow.....	C-5605
Fuel Filter.....	FC-5602	Oil Filter Full Flow.....	C-5701	Oil Filter Full Flow.....	C-5701
Fuel Filter.....	F-2626	Oil Filter Full Flow.....	C-5605	Oil Filter Full Flow.....	C-5715
Hydraulic Oil Filter.....	H-5606	<b>D155A-2</b> (DOZERS) S6D155-4S		Oil Filter Full Flow.....	C-5701
Hydraulic Oil Filter.....	H-56600	Fuel Filter.....	FC-5606	<b>D155AX-5SL</b> (DOZERS) SA6D140E	
Hydraulic Oil Filter.....	H-5610	<b>D155A-5</b> (DOZERS)		Air Filter Secondary.....	A-5610
Oil Filter By Pass.....	O-5704	Air Filter Secondary.....	A-5610	Air Filter Primary.....	A-5614
Oil Filter Full Flow.....	C-5605	Air Filter Primary.....	A-5614	Air Filter Primary.....	A-8665M
Oil Filter Full Flow.....	C-5701	Air Filter Primary.....	A-8665M	Air Filter Secondary.....	A-8580
Oil Filter Full Flow.....	C-5715	Air Filter Secondary.....	A-8580	Cabin Air Filter.....	CA-5602
<b>D150A-1</b> (DOZERS) S6D155-4/24805		Fuel Filter.....	FC-5703	Fuel Filter.....	FC-5703
Air Filter Secondary.....	A-5610	Fuel/Water Separator.....	SFC-5707	Fuel/Water Separator.....	SFC-5707
Air Filter Primary.....	A-5614	Hydraulic Oil Filter.....	H-56600	Oil Filter Full Flow.....	C-5605
Fuel Filter.....	FC-5602	Hydraulic Oil Filter.....	H-5610	Oil Filter Full Flow.....	C-5715
Fuel Filter.....	F-2626	Hydraulic Oil Filter.....	H-56610	Oil Filter Full Flow.....	C-5701
Hydraulic Oil Filter.....	H-56600	Hydraulic Breather.....	H-56610	<b>D155AX-6</b> (DOZERS) KOMATSU SAA6D140E-5G-02	
Hydraulic Oil Filter.....	H-5606	Oil Filter Full Flow.....	C-5605	Fuel/Water Separator.....	SFC-56020B
Hydraulic Oil Filter.....	H-5610	Oil Filter Full Flow.....	C-5715	Fuel/Water Separator.....	SFC-56020
Oil Filter Full Flow.....	C-5605	Oil Filter Full Flow.....	C-5701	Hydraulic Oil Filter additional part..	H-7105
Oil Filter By Pass.....	O-5704	<b>D155AX-5</b> (DOZERS) KOMATSU SA6D140E-3C-7		<b>D155AX-6</b> (DOZERS)	
Oil Filter Full Flow.....	C-5715	Fuel/Water Separator.....	SFC-56020	Air Filter Secondary.....	A-8580
Oil Filter Full Flow.....	C-5701	Fuel/Water Separator.....	SFC-56020B	Air Filter Primary.....	A-8665M
<b>D155</b> (DOZERS) S6D155		<b>D155AX-5</b> (DOZERS) KOMATSU SA6D140E-3J-7		Cabin Air Filter.....	CA-56041
Fuel Filter.....	FC-5602	Fuel/Water Separator.....	SFC-56020B	Cabin Air Filter.....	CA-5602
Oil Filter By Pass.....	O-5704	Fuel/Water Separator.....	SFC-56020	Fuel/Water Separator Secondary..	SFC-5611-10B
Oil Filter Full Flow.....	C-5701	<b>D155AX-5</b> (DOZERS) SA6D140E		Fuel/Water Separator Secondary..	SFC-5611-10
Oil Filter Full Flow.....	C-5605	Air Filter Secondary.....	A-8580	Hydraulic Oil Filter.....	H-5629
Oil Filter Full Flow.....	C-5715	Air Filter Secondary.....	A-5610	Hydraulic Oil Filter.....	H-56600
<b>D155A-1</b> (DOZERS) KOMATSU S6D155-4		Air Filter Primary.....	A-5614	Hydraulic Oil Filter.....	H-5646
Hydraulic Oil Filter Transmission...	H-56570	Air Filter Primary.....	A-8665M	<b>D155AX-6</b> (DOZERS) SAA6D140E-5	
<b>D155A-1</b> (DOZERS) S6D155		Fuel Filter.....	FC-5703	Air Filter Primary.....	A-8665M
Fuel Filter.....	FC-5606	Fuel/Water Separator.....	SFC-5707	Air Filter Secondary.....	A-8580
<b>D155A-1</b> (DOZERS) S6D155-4		Oil Filter Full Flow.....	C-5605	Cabin Air Filter.....	CA-5602
Air Filter Primary.....	A-5618	Oil Filter Full Flow.....	C-5701	Cabin Air Filter.....	CA-56041
Fuel Filter.....	FC-5602	Oil Filter Full Flow.....	C-5715	Fuel/Water Separator Secondary..	SFC-5611-10B
Fuel Filter.....	F-2626	<b>D155AX-5</b> (DOZERS) S/N: 70001		Fuel/Water Separator Secondary..	SFC-5611-10
Fuel Filter.....	F-2604	Air Filter Secondary.....	A-5610	Hydraulic Oil Filter.....	H-5646
Oil Filter Full Flow.....	C-5605	Air Filter Primary.....	A-5614	Hydraulic Oil Filter.....	H-56600
Oil Filter Full Flow.....	C-5701	Fuel Filter.....	FC-5703	Hydraulic Oil Filter.....	H-5629
Oil Filter Full Flow.....	O-5501	Fuel/Water Separator.....	SFC-5707	<b>D155AX-6SL</b> (DOZERS) SAA6D140E-5	
Oil Filter Full Flow.....	C-5715	Hydraulic Oil Filter.....	H-56600	Air Filter Primary.....	A-8665M
Oil Filter By Pass.....	O-5704	Oil Filter Full Flow.....	C-5605	Air Filter Secondary.....	A-8580
Oil Filter Full Flow.....	O-5601	Oil Filter Full Flow.....	C-5715	Cabin Air Filter.....	CA-5602
<b>D155A-2</b> (DOZERS) S6D155-4/50001		Oil Filter Full Flow.....	C-5701	Cabin Air Filter.....	CA-56041
Air Filter Secondary.....	A-5610	<b>D155AX-5B</b> (DOZERS) SA6D140E		Fuel/Water Separator Secondary..	SFC-5611-10B
		Air Filter Secondary.....	A-8580	Fuel/Water Separator Secondary..	SFC-5611-10
		Air Filter Secondary.....	A-5610	Hydraulic Oil Filter.....	H-56600
				<b>D155C-1</b> (DOZERS) S6D155	

MODEL/APPLICATION	SAKURA NO	MODEL/APPLICATION	SAKURA NO	MODEL/APPLICATION	SAKURA NO
<b>KOMATSU</b>		<b>KOMATSU</b>		<b>KOMATSU</b>	
<b>D155C-1</b> (DOZERS) S6D155		Hydraulic Oil Filter.....	H-5610	<b>D20A-2</b> (DOZERS) C221	
Fuel Filter.....	FC-5606	Hydraulic Oil Filter.....	H-56600	Fuel Filter.....	F-1501
<b>D155C-1</b> (DOZERS) S6D155-4/15686		Oil Filter Full Flow.....	C-5605	Hydraulic Oil Filter.....	H-5611
Air Filter Secondary.....	A-5610	Oil Filter Full Flow.....	C-5701	Oil Filter Full Flow.....	O-1803
Air Filter Primary.....	A-5614	Oil Filter Full Flow.....	C-5715	<b>D20A-3</b> (DOZERS) 4D130-1	
Fuel Filter.....	FC-5602	<b>D155EX</b> (DOZERS)		Air Filter Set.....	A-5608-S
Hydraulic Oil Filter.....	H-5601	Fuel/Water Separator Secondary... SFC-5611-10		Air Filter Primary.....	A-5608
Hydraulic Oil Filter.....	H-5606	Fuel/Water Separator Secondary.. SFC-5611-10B		Fuel Filter.....	F-1501
Hydraulic Oil Filter.....	H-5608	Hydraulic Oil Filter.....	H-56600	Hydraulic Oil Filter.....	H-5611
Oil Filter Full Flow.....	C-5715	<b>D155A-6</b> (DOZERS) KOMATSU SAA6D140E-5		Oil Filter Full Flow.....	C-5606
Oil Filter By Pass.....	O-5704	Fuel/Water Separator.....	SFC-56020	<b>D20A-5</b> (DOZERS)	
Oil Filter Full Flow.....	C-5605	Fuel/Water Separator.....	SFC-56020B	Air Filter Primary.....	AS-5620
Oil Filter Full Flow.....	C-5701	<b>D155A-6</b> (DOZERS) KOMATSU SAA6D140E-5GR-W		Fuel Filter.....	FC-5604
<b>D155S-1</b> (DOZERS) S6D155		Hydraulic Oil Filter additional part.. H-7105		Oil Filter Full Flow.....	C-5606
Air Filter Secondary.....	A-5610	<b>D155A-2A</b> (DOZERS) SA6D140E		<b>D20A-7</b> (DOZERS)	
Air Filter Primary.....	A-5614	Fuel Filter.....	FC-5606	Air Filter Secondary.....	A-8599
Coolant Filter.....	WC-5712	<b>D155A-6R</b> (DOZERS) KOMATSU SAA6D140E-5		Air Filter Secondary.....	A-5621
Fuel Filter.....	FC-5602	Fuel/Water Separator.....	SFC-56020	Air Filter Primary.....	AS-5620
Fuel Filter.....	FC-5606	Fuel/Water Separator.....	SFC-56020B	Air Filter Primary.....	A-8505
Fuel Filter.....	F-2604	<b>D155AX-6A</b> (DOZERS) KOMATSU SAA6D140E-5G-02		Fuel Filter.....	FC-1801
Hydraulic Oil Filter.....	H-5606	Fuel/Water Separator.....	SFC-56020	Fuel Filter.....	FC-1016
Oil Filter By Pass.....	O-5704	Fuel/Water Separator.....	SFC-56020B	Oil Filter Full Flow.....	C-5604
Oil Filter Full Flow.....	O-5601	<b>D20</b> (DOZERS) 4D92		<b>D20P</b> (DOZERS) 4D130-1	
Oil Filter Full Flow.....	C-5701	Air Filter Primary.....	AS-5620	Air Filter Primary.....	A-5608
Oil Filter Full Flow.....	C-5715	Fuel Filter.....	FC-5604	Air Filter Set.....	A-5608-S
Oil Filter Full Flow.....	C-5605	Oil Filter Full Flow.....	C-5606	Fuel Filter.....	F-1501
<b>D155S-1</b> (DOZERS) S6D155/1001		<b>D20</b> (DOZERS) 4D94/45001		Hydraulic Oil Filter.....	H-5611
Air Filter Secondary.....	A-5610	Air Filter Primary.....	AS-5620	Oil Filter Full Flow.....	C-5606
Air Filter Primary.....	A-5614	Air Filter Secondary.....	A-5621	<b>D20P</b> (DOZERS) 4D92	
Fuel Filter.....	FC-5602	Air Filter Primary.....	AS-1014	Air Filter Primary.....	AS-5620
Fuel Filter.....	F-2604	Fuel Filter.....	FC-5604	Fuel Filter.....	FC-5604
Hydraulic Oil Filter.....	H-5606	Hydraulic Oil Filter.....	HC-5602	Oil Filter Full Flow.....	C-5606
Oil Filter Full Flow.....	C-5605	Oil Filter Full Flow.....	C-5606	<b>D20P-2</b> (DOZERS) C221	
Oil Filter Full Flow.....	C-5701	<b>D20</b> (DOZERS) 4D95S/75001		Fuel Filter.....	F-1501
Oil Filter By Pass.....	O-5704	Air Filter Secondary.....	A-5621	Hydraulic Oil Filter.....	H-5611
<b>D155S-1</b> (DOZERS) S6D155-4/25200		Air Filter Primary.....	AS-5620	Oil Filter Full Flow.....	O-1803
Air Filter Secondary.....	A-5610	Fuel Filter.....	FC-1801	<b>D20P-3</b> (DOZERS) 4D130-1	
Air Filter Primary.....	A-5614	Hydraulic Oil Filter.....	HC-5602	Air Filter Primary.....	A-5608
Fuel Filter.....	FC-5602	Oil Filter Full Flow.....	C-5604	Air Filter Set.....	A-5608-S
Fuel Filter.....	F-2626	<b>D20-7</b> (DOZERS) 4D955		Fuel Filter.....	F-1501
Hydraulic Oil Filter.....	H-5606	Air Filter Primary.....	AS-5620	Hydraulic Oil Filter.....	H-5611
Oil Filter Full Flow.....	C-5605	Air Filter Secondary.....	A-5621	Oil Filter Full Flow.....	C-5606
Oil Filter Full Flow.....	C-5715	Fuel Filter.....	FC-1801	<b>D20P-5</b> (DOZERS)	
Oil Filter Full Flow.....	C-5701	Hydraulic Oil Filter.....	HC-5602	Air Filter Primary.....	AS-5620
Oil Filter By Pass.....	O-5704	Oil Filter Full Flow.....	C-5604	Fuel Filter.....	FC-5604
<b>D155AX-3</b> (DOZERS) S6D140-1/60001		<b>D20P-7</b> (DOZERS)		Oil Filter Full Flow.....	C-5606
Air Filter Secondary.....	A-5610	Air Filter Primary.....	AS-5620	<b>D20P-7</b> (DOZERS)	
Air Filter Primary.....	A-5614	Air Filter Secondary.....	A-5621	Air Filter Primary.....	AS-5620
Fuel Filter.....	FC-5703	Fuel Filter.....	FC-1801	Fuel Filter.....	FC-5604
Fuel/Water Separator.....	SFC-5707	Hydraulic Oil Filter.....	HC-5602	Oil Filter Full Flow.....	C-5606
		Oil Filter Full Flow.....	C-5604		

# Sakura Filter

# ENGINE APPLICATION

MODEL/APPLICATION	SAKURA NO	MODEL/APPLICATION	SAKURA NO	MODEL/APPLICATION	SAKURA NO
<b>KOMATSU</b>		<b>KOMATSU</b>		<b>KOMATSU</b>	
<b>D20P-7</b> (DOZERS)		Air Filter Primary.....	AS-5620	Fuel Filter.....	FC-5604
Air Filter Primary.....	A-8505	Fuel Filter.....	FC-5604	Hydraulic Oil Filter.....	HC-5602
Air Filter Secondary.....	A-8599	Oil Filter Full Flow.....	C-5606	<b>D21A-8</b> (DOZERS) 4D94LE-2	
Air Filter Primary.....	AS-5620	<b>D20P-6A</b> (DOZERS) 4D95S-W-1F-AP		Air Filter Primary.....	A-8505
Air Filter Secondary.....	A-5621	Oil Filter Full Flow.....	C-5615	Air Filter Secondary.....	A-8599
Fuel Filter.....	FC-1801	Oil Filter Full Flow.....	C-5616	<b>D21E-6</b> (DOZERS) 4D95S-W/60001	
Fuel Filter.....	FC-1016	<b>D20P-7A</b> (DOZERS) 4D95S-1H		Air Filter Primary.....	AS-5620
Oil Filter Full Flow.....	C-5604	Oil Filter Full Flow.....	C-5615	Air Filter Secondary.....	A-5621
<b>D20PL-5</b> (DOZERS) 4D92		Oil Filter Full Flow.....	C-5616	Fuel Filter.....	FC-5604
Air Filter Primary.....	AS-5620	<b>D20P-7A-M</b> (DOZERS) 4D94E-1A		Hydraulic Oil Filter.....	HC-5602
Fuel Filter.....	FC-5604	Oil Filter Full Flow.....	C-5615	<b>D21P</b> (DOZERS) 4D130-1	
Oil Filter Full Flow.....	C-5606	Oil Filter Full Flow.....	C-5616	Air Filter Set.....	A-5608-S
<b>D20Q</b> (LOADERS) 4D92		<b>D21</b> (DOZERS) FH-37		Air Filter Primary.....	A-5608
Air Filter Primary.....	AS-5620	Hydraulic Oil Filter.....	H-5608	Fuel Filter.....	F-1501
Fuel Filter.....	FC-5604	Hydraulic Oil Filter.....	H-5611	Hydraulic Oil Filter.....	H-5611
Oil Filter Full Flow.....	C-5606	<b>D21-7</b> (DOZERS) 4D95S/75001		Oil Filter Full Flow.....	C-5606
<b>D20Q-3</b> (LOADERS) 4D130-1		Air Filter Primary.....	AS-5620	<b>D21P</b> (DOZERS) 4D92	
Air Filter Set.....	A-5608-S	Air Filter Secondary.....	A-5621	Air Filter Primary.....	AS-5620
Fuel Filter.....	F-1501	Fuel Filter.....	FC-1801	Fuel Filter.....	FC-5604
Hydraulic Oil Filter.....	H-5611	Hydraulic Oil Filter.....	HC-5602	Oil Filter Full Flow.....	C-5606
Oil Filter Full Flow.....	C-5606	Oil Filter Full Flow.....	C-5604	<b>D21P-3</b> (DOZERS) 4D130-1	
<b>D20Q-5</b> (LOADERS)		<b>D21A</b> (DOZERS) 4D130-1		Air Filter Primary.....	A-5608
Air Filter Primary.....	AS-5620	Air Filter Set.....	A-5608-S	Air Filter Set.....	A-5608-S
Fuel Filter.....	FC-5604	Air Filter Primary.....	A-5608	Fuel Filter.....	F-1501
Oil Filter Full Flow.....	C-5606	Fuel Filter.....	F-1501	Hydraulic Oil Filter.....	H-5611
<b>D20S</b> (LOADERS) 4D130-1		Hydraulic Oil Filter.....	H-5611	Oil Filter Full Flow.....	C-5606
Air Filter Set.....	A-5608-S	Oil Filter Full Flow.....	C-5606	<b>D21P-5</b> (DOZERS) 4D94/45001	
Air Filter Primary.....	A-5608	<b>D21A</b> (DOZERS) 4D92		Air Filter Primary.....	AS-5620
Fuel Filter.....	F-1501	Air Filter Primary.....	AS-5620	Air Filter Primary.....	AS-1014
Hydraulic Oil Filter.....	H-5611	Fuel Filter.....	FC-5604	Air Filter Secondary.....	A-5621
Oil Filter Full Flow.....	C-5606	Oil Filter Full Flow.....	C-5606	Fuel Filter.....	FC-5604
<b>D20S</b> (LOADERS) 4D92		<b>D21A-3</b> (DOZERS) 4D130-1		Hydraulic Oil Filter.....	HC-5602
Air Filter Primary.....	AS-5620	Air Filter Set.....	A-5608-S	Oil Filter Full Flow.....	C-5606
Fuel Filter.....	FC-5604	Air Filter Primary.....	A-5608	<b>D21P-6</b> (DOZERS) 4D95S-W/60001	
Oil Filter Full Flow.....	C-5606	Fuel Filter.....	F-1501	Air Filter Primary.....	AS-5620
<b>D20S-2</b> (LOADERS) C221		Hydraulic Oil Filter.....	H-5611	Air Filter Secondary.....	A-5621
Fuel Filter.....	F-1501	Oil Filter Full Flow.....	C-5606	Fuel Filter.....	FC-5604
Hydraulic Oil Filter.....	H-5611	<b>D21A-5</b> (DOZERS) 4D94/45001		Hydraulic Oil Filter.....	HC-5602
Oil Filter Full Flow.....	O-1803	Air Filter Primary.....	AS-1014	Oil Filter Full Flow.....	C-5606
<b>D20S-3</b> (LOADERS) 4D130-1		Air Filter Secondary.....	A-5621	<b>D21P-6B</b> (DOZERS) 4D95S-W	
Air Filter Set.....	A-5608-S	Air Filter Primary.....	AS-5620	Air Filter Primary.....	AS-5620
Air Filter Primary.....	A-5608	Fuel Filter.....	FC-5604	Air Filter Secondary.....	A-5621
Fuel Filter.....	F-1501	Hydraulic Oil Filter.....	HC-5602	Fuel Filter.....	FC-5604
Hydraulic Oil Filter.....	H-5611	Oil Filter Full Flow.....	C-5606	Hydraulic Oil Filter.....	HC-5602
Oil Filter Full Flow.....	C-5606	<b>D21A-6</b> (DOZERS) 4D95S-W/60001		<b>D21P-8</b> (DOZERS) 4D94LE-2	
<b>D20S-5</b> (LOADERS)		Air Filter Primary.....	AS-5620	Air Filter Primary.....	A-8505
Air Filter Primary.....	AS-5620	Air Filter Secondary.....	A-5621	Air Filter Secondary.....	A-8599



MODEL/APPLICATION	SAKURA NO
<b>KOMATSU</b>	
<b>D21PL-5</b> (DOZERS) 4D92	
Air Filter Primary.....	AS-5620
Fuel Filter.....	FC-5604
Oil Filter Full Flow.....	C-5606
<b>D21PL-5</b> (DOZERS) 4D94/45001	
Air Filter Primary.....	AS-5620
Air Filter Secondary.....	A-5621
Air Filter Primary.....	AS-1014
Fuel Filter.....	FC-5604
Hydraulic Oil Filter.....	HC-5602
Oil Filter Full Flow.....	C-5606
<b>D21PL-6</b> (DOZERS) 4D95S-W/60001	
Air Filter Secondary.....	A-5621
Air Filter Primary.....	AS-5620
Fuel Filter.....	FC-5604
Hydraulic Oil Filter.....	HC-5602
<b>D21PLL-5</b> (DOZERS) 4D94/45001	
Air Filter Primary.....	AS-5620
Air Filter Secondary.....	A-5621
Air Filter Primary.....	AS-1014
Fuel Filter.....	FC-5604
Hydraulic Oil Filter.....	HC-5602
Oil Filter Full Flow.....	C-5606
<b>D21PLL-6</b> (DOZERS) 4D95S-W/60001	
Air Filter Primary.....	AS-5620
Air Filter Secondary.....	A-5621
Fuel Filter.....	FC-5604
Hydraulic Oil Filter.....	HC-5602
<b>D21Q</b> (LOADERS) 4D92	
Air Filter Primary.....	AS-5620
Fuel Filter.....	FC-5604
Oil Filter Full Flow.....	C-5606
<b>D21Q-3</b> (LOADERS) 4D130-1	
Air Filter Set.....	A-5608-S
Air Filter Primary.....	A-5608
Fuel Filter.....	F-1501
Hydraulic Oil Filter.....	H-5611
Oil Filter Full Flow.....	C-5606
<b>D21Q-5</b> (LOADERS) 4D94/45001	
Air Filter Secondary.....	A-5621
Air Filter Primary.....	AS-1014
Air Filter Primary.....	AS-5620
Fuel Filter.....	FC-5604
Hydraulic Oil Filter.....	HC-5602
Oil Filter Full Flow.....	C-5606
<b>D21Q-6</b> (LOADERS) 4D95S-W/60001	
Air Filter Primary.....	AS-5620
Air Filter Secondary.....	A-5621

MODEL/APPLICATION	SAKURA NO
<b>KOMATSU</b>	
Fuel Filter.....	FC-5604
Hydraulic Oil Filter.....	HC-5602
<b>D21S</b> (LOADERS) 4D130-1	
Air Filter Primary.....	A-5608
Air Filter Set.....	A-5608-S
Fuel Filter.....	F-1501
Hydraulic Oil Filter.....	H-5611
Oil Filter Full Flow.....	C-5606
<b>D21S</b> (LOADERS) 4D92	
Air Filter Primary.....	AS-5620
Fuel Filter.....	FC-5604
Oil Filter Full Flow.....	C-5606
<b>D21S-3</b> (LOADERS) 4D130-1	
Air Filter Primary.....	A-5608
Air Filter Set.....	A-5608-S
Fuel Filter.....	F-1501
Hydraulic Oil Filter.....	H-5611
Oil Filter Full Flow.....	C-5606
<b>D21S-5</b> (LOADERS) 4D94/45001	
Air Filter Primary.....	AS-5620
Air Filter Secondary.....	A-5621
Air Filter Primary.....	AS-1014
Fuel Filter.....	FC-5604
Hydraulic Oil Filter.....	HC-5602
Oil Filter Full Flow.....	C-5606
<b>D21S-5</b> (LOADERS) FH-35	
Hydraulic Oil Filter.....	H-5608
Hydraulic Oil Filter.....	H-5611
<b>D21S-6</b> (LOADERS) 4D95S-W/60001	
Air Filter Secondary.....	A-5621
Air Filter Primary.....	AS-5620
Fuel Filter.....	FC-5604
Hydraulic Oil Filter.....	HC-5602
<b>D21A-7</b> (DOZERS) 4D94E	
Air Filter Primary.....	A-8505
Air Filter Secondary.....	A-5621
Air Filter Primary.....	AS-1014
Air Filter Secondary.....	A-8599
Air Filter Primary.....	AS-5620
Fuel Filter.....	FC-1801
Fuel Filter.....	FC-1016
Oil Filter Full Flow.....	C-5604
<b>D21P-7</b> (DOZERS) 4D94E	
Air Filter Primary.....	AS-1014
Air Filter Primary.....	A-8505
Air Filter Secondary.....	A-8599
Air Filter Secondary.....	A-5621
Air Filter Primary.....	AS-5620
Fuel Filter.....	FC-1801
Fuel Filter.....	FC-1016

MODEL/APPLICATION	SAKURA NO
<b>KOMATSU</b>	
Oil Filter Full Flow.....	C-5604
<b>D275A-2</b> (DOZERS) S6D170	
Fuel Filter.....	FC-5606
<b>D275A-2</b> (DOZERS) S6D170-1/10001	
Air Filter Secondary.....	A-5610
Air Filter Primary.....	A-5614
Coolant Filter.....	WC-56010
Fuel Filter.....	FC-5602
Hydraulic Oil Filter.....	H-5610
Hydraulic Oil Filter.....	H-56600
Oil Filter Full Flow.....	C-5605
Oil Filter Full Flow.....	C-5715
Oil Filter Full Flow.....	C-5701
<b>D275A-2D</b> (DOZERS) S6D170	
Fuel Filter.....	FC-5606
<b>D275A-2D</b> (DOZERS) S6D170-1	
Air Filter Secondary.....	A-5610
Air Filter Primary.....	A-5614
Coolant Filter.....	WC-56010
Fuel Filter.....	FC-5602
Hydraulic Oil Filter.....	H-5610
Hydraulic Oil Filter.....	H-56600
Oil Filter Full Flow.....	C-5605
Oil Filter Full Flow.....	C-5701
Oil Filter Full Flow.....	C-5715
<b>D275AX-5</b> (DOZERS) SDA6D140E	
Air Filter Secondary.....	A-8580
Air Filter Primary.....	A-8665M
Cabin Air Filter.....	CA-56041
Cabin Air Filter Set.....	CA-5601-S
Fuel/Water Separator.....	SFC-5601-02
Fuel/Water Separator Secondary..	SFC-5611-10B
Fuel/Water Separator Secondary..	SFC-5611-10
<b>D275AX-5E0</b> (DOZERS) KOMATSU SAA6D140E-5H	
Fuel/Water Separator.....	SFC-56020
Fuel/Water Separator.....	SFC-56020B
<b>D275AX-5E0</b> (DOZERS) SAA6D140E-5	
Air Filter Secondary.....	A-8580
Air Filter Primary.....	A-8665M
Cabin Air Filter Set.....	CA-5601-S
Cabin Air Filter.....	CA-56041
Fuel/Water Separator Secondary..	SFC-5611-10B
Fuel/Water Separator Secondary..	SFC-5611-10
Hydraulic Oil Filter.....	H-5646
Hydraulic Oil Filter.....	H-5629
Hydraulic Oil Filter.....	H-56600
<b>D275AX-5S1</b> (DOZERS) SDA6D140E	
Air Filter Primary.....	A-8665M
Air Filter Secondary.....	A-8580

MODEL/APPLICATION	SAKURA NO	MODEL/APPLICATION	SAKURA NO	MODEL/APPLICATION	SAKURA NO
<b>KOMATSU</b>		<b>KOMATSU</b>		<b>KOMATSU</b>	
D275AX-5SL (DOZERS) SDA6D140E		Air Filter Set.....	A-5608-S	Fuel Filter Secondary.....	FC-7903
Cabin Air Filter Set.....	CA-5601-S	Hydraulic Oil Filter.....	H-5608	Fuel/Water Separator.....	SFC-5708
Cabin Air Filter.....	CA-56041	<b>D30Q-15</b> (LOADERS) 4D92		Hydraulic Oil Filter.....	HC-5602
Fuel/Water Separator Secondary..	SFC-5611-10	Air Filter Primary.....	A-5608	Oil Filter Full Flow.....	C-5703
Fuel/Water Separator.....	SFC-5601-02	Air Filter Set.....	A-5608-S		
Fuel/Water Separator Secondary..	SFC-5611-10B	Hydraulic Oil Filter.....	H-5608	<b>D31A</b> (DOZERS) 4D105	
		Oil Filter Full Flow.....	C-5606	Air Filter Primary.....	A-5616
<b>D275A</b> (DOZERS)		<b>D30S</b> (LOADERS) 4D105		Air Filter Set.....	A-5655-S
Fuel/Water Separator Secondary..	SFC-5611-10B	Air Filter Set.....	A-5608-S	Air Filter Secondary.....	A-5617
Fuel/Water Separator Secondary..	SFC-5611-10	Air Filter Primary.....	A-5608	Hydraulic Oil Filter.....	H-5608
Hydraulic Oil Filter.....	H-5646	Hydraulic Oil Filter.....	H-5608		
Hydraulic Oil Filter.....	H-5629			<b>D31A</b> (DOZERS) 4D105-1	
<b>D275A-5R</b> (DOZERS) KOMATSU SAA6D140E-5		<b>D30S-12</b> (LOADERS) DA220		Air Filter Secondary.....	A-5617
Fuel Filter.....	FC-5614	Air Filter Set.....	A-5608-S	Air Filter Primary.....	A-5616
Fuel Filter.....	FC-56230	Air Filter Primary.....	A-5608	Air Filter Set.....	A-5655-S
<b>D275A-5R</b> (DOZERS) KOMATSU SAA6D140E-5AH		Hydraulic Oil Filter.....	H-5608	Fuel Filter.....	FC-5605
Fuel/Water Separator.....	SFC-56020	Oil Filter Full Flow.....	C-5606	Hydraulic Oil Filter.....	HC-5601
Fuel/Water Separator.....	SFC-56020B			Oil Filter Full Flow.....	C-6202
<b>D275A-5R</b> (DOZERS) KOMATSU SAA6D140E-5HR		<b>D30S-15</b> (LOADERS) 4D92		<b>D31A</b> (DOZERS) 4D92	
Fuel/Water Separator.....	SFC-56020	Air Filter Set.....	A-5608-S	Air Filter Secondary.....	A-5617
Fuel/Water Separator.....	SFC-56020B	Air Filter Primary.....	A-5608	Air Filter Primary.....	A-5616
		Hydraulic Oil Filter.....	H-5608	Air Filter Set.....	A-5655-S
		Oil Filter Full Flow.....	C-5606	Fuel Filter.....	FC-5605
<b>D30A</b> (DOZERS) 4D105		<b>D31</b> (DOZERS) FH-63		Hydraulic Oil Filter.....	HC-5601
Air Filter Set.....	A-5608-S	Fuel Filter.....	FC-5605	Oil Filter Full Flow.....	C-6202
Air Filter Primary.....	A-5608	Hydraulic Oil Filter.....	H-5611		
Hydraulic Oil Filter.....	H-5608	Oil Filter Full Flow.....	C-5606	<b>D31A-15</b> (DOZERS) 4D92	
<b>D30A-12</b> (DOZERS) DA220		<b>D31-17</b> (DOZERS) S/N: 32001		Air Filter Secondary.....	A-5617
Fuel Filter.....	F-1303	Air Filter Secondary.....	A-7806	Air Filter Set.....	A-5655-S
<b>D30A-15</b> (DOZERS) 4D92		Air Filter Primary.....	AS-7805	Air Filter Primary.....	A-5616
Air Filter Primary.....	A-5608	Hydraulic Oil Filter.....	HC-5601	Hydraulic Oil Filter.....	H-5608
Air Filter Set.....	A-5608-S	Oil Filter Full Flow.....	C-5606	Oil Filter Full Flow.....	C-5606
Hydraulic Oil Filter.....	H-5608	<b>D31-18</b> (DOZERS) S/N: 40001		<b>D31A-16</b> (DOZERS) 4D105-1	
Oil Filter Full Flow.....	C-5606	Air Filter Primary.....	AS-7805	Air Filter Primary.....	A-5616
<b>D30P</b> (DOZERS) 4D105		Air Filter Secondary.....	A-7806	Air Filter Set.....	A-5655-S
Air Filter Set.....	A-5608-S	Fuel Filter.....	FC-5604	Air Filter Secondary.....	A-5617
Air Filter Primary.....	A-5608	Hydraulic Oil Filter.....	HC-5602	Fuel Filter.....	FC-5605
Hydraulic Oil Filter.....	H-5608	Oil Filter Full Flow.....	C-5604	Hydraulic Oil Filter.....	HC-5601
<b>D30P-12</b> (DOZERS) DA220		<b>D31-20</b> (DOZERS) 6D95L-1/42001 - 42722/96999		Oil Filter Full Flow.....	C-6202
Fuel Filter.....	F-1303	Air Filter Primary.....	AS-7805	<b>D31A-17</b> (DOZERS) 4D92	
<b>D30P-15</b> (DOZERS) 4D92		Air Filter Secondary.....	A-7806	Air Filter Primary.....	A-5616
Air Filter Set.....	A-5608-S	Fuel Filter.....	FC-1801	Air Filter Set.....	A-5655-S
Air Filter Primary.....	A-5608	Hydraulic Oil Filter.....	HC-5602	Air Filter Secondary.....	A-5617
Hydraulic Oil Filter.....	H-5608	Oil Filter Full Flow.....	C-5604	Fuel Filter.....	FC-5605
Oil Filter Full Flow.....	C-5606	<b>D31-20</b> (DOZERS) 6D95L-1/42001/42722/100413		Hydraulic Oil Filter.....	HC-5601
<b>D30Q-15</b> (LOADERS) 4D105		Air Filter Secondary.....	A-7806	Oil Filter Full Flow.....	C-6202
Air Filter Primary.....	A-5608	Air Filter Primary.....	AS-7805	<b>D31A-17</b> (DOZERS) 4D105/32001	
<b>D30Q-15</b> (LOADERS) 4D105		Fuel Filter.....	FC-1801	Air Filter Secondary.....	A-7806
Air Filter Primary.....	A-5608	Oil Filter Full Flow.....	C-5604	Air Filter Primary.....	AS-7805
		<b>D31-20</b> (DOZERS) S4D102E-1/42723		Fuel Filter.....	FC-5604
		Air Filter Primary.....	A-5627	Hydraulic Oil Filter.....	HC-5602
		Air Filter Secondary.....	A-6008	Oil Filter Full Flow.....	C-5614
		Air Filter Set.....	A-5663-S	<b>D31E-17</b> (DOZERS) 6D105-5T	

# Sakura Filter

# ENGINE APPLICATION

MODEL/APPLICATION	SAKURA NO	MODEL/APPLICATION	SAKURA NO	MODEL/APPLICATION	SAKURA NO
<b>KOMATSU</b>		<b>KOMATSU</b>		<b>KOMATSU</b>	
<b>D31E-17</b> (DOZERS) 6D105-5T		<b>D31P-15</b> (DOZERS) 4D92		Air Filter Secondary.....	A-7806
Air Filter Primary.....	AS-7805	Air Filter Secondary.....	A-5617	Air Filter Primary.....	AS-7805
Air Filter Secondary.....	A-7806	Air Filter Set.....	A-5655-S	Fuel Filter.....	FC-1801
Fuel Filter.....	FC-5604	Air Filter Primary.....	A-5616	Hydraulic Oil Filter.....	HC-5602
Oil Filter Full Flow.....	C-5614	Hydraulic Oil Filter.....	H-5608	Oil Filter Full Flow.....	C-5604
<b>D31E-18</b> (DOZERS) 6D95L-1/40001		<b>D31P-16</b> (DOZERS) 4D105-1		<b>D31PL-17</b> (DOZERS) 4D105/32001	
Air Filter Primary.....	AS-7805	Air Filter Primary.....	A-5616	Air Filter Secondary.....	A-7806
Air Filter Secondary.....	A-7806	Air Filter Set.....	A-5655-S	Air Filter Primary.....	AS-7805
Fuel Filter.....	FC-5604	Air Filter Secondary.....	A-5617	Fuel Filter.....	FC-5604
Hydraulic Oil Filter.....	HC-5602	Fuel Filter.....	FC-5605	Hydraulic Oil Filter.....	HC-5602
Oil Filter Full Flow.....	C-5604	Hydraulic Oil Filter.....	HC-5601	Oil Filter Full Flow.....	C-5614
<b>D31E-20</b> (DOZERS) 6D95L		<b>D31P-16</b> (DOZERS) 4D92		<b>D31PL-18</b> (DOZERS) 6D95L-1/40001	
Air Filter Primary.....	A-5627	Air Filter Secondary.....	A-5617	Air Filter Primary.....	AS-7805
Air Filter Set.....	A-5663-S	Air Filter Set.....	A-5655-S	Air Filter Secondary.....	A-7806
Air Filter Primary.....	AS-7805	Air Filter Primary.....	A-5616	Fuel Filter.....	FC-5604
Fuel Filter.....	FC-1801	Fuel Filter.....	FC-5605	Hydraulic Oil Filter.....	HC-5602
Oil Filter Full Flow.....	C-5405	Hydraulic Oil Filter.....	HC-5601	Oil Filter Full Flow.....	C-5604
<b>D31E-20</b> (DOZERS) S4D102E		<b>D31P-16A</b> (DOZERS) 4D105-3		<b>D31PLL-17</b> (DOZERS) 4D105/32001	
Air Filter Primary.....	A-5627	Fuel Filter.....	FC-5605	Air Filter Primary.....	AS-7805
Air Filter Set.....	A-5663-S	Oil Filter Full Flow.....	C-5606	Air Filter Secondary.....	A-7806
<b>D31EX</b> (DOZERS) S4D102E		<b>D31P-17</b> (DOZERS) 4D105/32001		Fuel Filter.....	FC-5604
Air Filter Primary.....	A-5627	Air Filter Primary.....	AS-7805	Hydraulic Oil Filter.....	HC-5602
Air Filter Set.....	A-5663-S	Air Filter Secondary.....	A-7806	Oil Filter Full Flow.....	C-5614
<b>D31EX-12</b> (DOZERS) SAA4D102E		Fuel Filter.....	FC-5604	<b>D31PX-21</b> (DOZERS) SAA4D102E	
Air Filter Secondary.....	A-5674	Hydraulic Oil Filter.....	HC-5602	Air Filter Set.....	A-5675-S
Air Filter Set.....	A-5675-S	Oil Filter Full Flow.....	C-5614	Air Filter Primary.....	A-5673
Air Filter Primary.....	A-5673	<b>D31P-17A</b> (DOZERS) 6D105-5T		Air Filter Secondary.....	A-5674
Air Filter Secondary.....	A-8670	Air Filter Secondary.....	A-7806	Air Filter Secondary.....	A-8670
Cabin Air Filter.....	CA-56070	Fuel Filter.....	FC-5604	Cabin Air Filter.....	CA-56041
<b>D31P</b> (DOZERS) 4D105		Hydraulic Oil Filter.....	HC-5602	Cabin Air Filter.....	CA-56070
Air Filter Set.....	A-5655-S	Oil Filter Full Flow.....	C-5614	Fuel Filter.....	F-5218
Air Filter Secondary.....	A-5617	<b>D31P-17B</b> (DOZERS) 6D105-5T		<b>D31Q-15</b> (DOZERS) 4D105	
Air Filter Primary.....	A-5616	Air Filter Secondary.....	A-7806	Air Filter Secondary.....	A-5617
Hydraulic Oil Filter.....	H-5608	Fuel Filter.....	FC-5604	Air Filter Set.....	A-5655-S
<b>D31P</b> (DOZERS) 4D105-1		Oil Filter Full Flow.....	C-5614	Air Filter Primary.....	A-5616
Air Filter Primary.....	A-5616	<b>D31P-18</b> (DOZERS) 6D95L-1/40001		Hydraulic Oil Filter.....	H-5608
Air Filter Set.....	A-5655-S	Air Filter Primary.....	AS-7805	Oil Filter Full Flow.....	C-5606
Air Filter Secondary.....	A-5617	Air Filter Secondary.....	A-7806	<b>D31Q-15</b> (DOZERS) 4D92	
Fuel Filter.....	FC-5605	Fuel Filter.....	FC-5604	Air Filter Secondary.....	A-5617
Hydraulic Oil Filter.....	HC-5601	Hydraulic Oil Filter.....	HC-5602	Air Filter Set.....	A-5655-S
Oil Filter Full Flow.....	C-6202	Oil Filter Full Flow.....	C-5614	Air Filter Primary.....	A-5616
<b>D31P</b> (DOZERS) 4D92		<b>D31P-18</b> (DOZERS) S4D102E		Hydraulic Oil Filter.....	H-5608
Air Filter Secondary.....	A-5617	Air Filter Primary.....	AS-7805	Oil Filter Full Flow.....	C-5606
Air Filter Primary.....	A-5616	Air Filter Secondary.....	A-7806	<b>D31Q-16</b> (DOZERS) 4D105-1	
Air Filter Set.....	A-5655-S	Fuel Filter.....	FC-5604	Air Filter Set.....	A-5655-S
Fuel Filter.....	FC-5605	Hydraulic Oil Filter.....	HC-5602	Air Filter Secondary.....	A-5617
Hydraulic Oil Filter.....	HC-5601	Oil Filter Full Flow.....	C-5604	Air Filter Primary.....	A-5616
Oil Filter Full Flow.....	C-6202	<b>D31P-20A</b> (DOZERS)		Fuel Filter.....	FC-5605
<b>D31P</b> (DOZERS) 4D92		Air Filter Primary.....	A-5627	Hydraulic Oil Filter.....	HC-5601
Air Filter Secondary.....	A-5617	Air Filter Set.....	A-5663-S	Oil Filter Full Flow.....	C-6202
Air Filter Primary.....	A-5616	<b>D31P-20A</b> (DOZERS)			
Air Filter Set.....	A-5655-S	Air Filter Primary.....	A-5627		
Fuel Filter.....	FC-5605	Air Filter Set.....	A-5663-S		
Hydraulic Oil Filter.....	HC-5601				
Oil Filter Full Flow.....	C-6202				

MODEL/APPLICATION	SAKURA NO	MODEL/APPLICATION	SAKURA NO	MODEL/APPLICATION	SAKURA NO
<b>KOMATSU</b>		<b>KOMATSU</b>		<b>KOMATSU</b>	
<b>D31Q-16</b> (DOZERS) 4D92		Hydraulic Oil Filter.....	HC-5601	<b>D355</b> (DOZERS)	
Air Filter Primary.....	A-5616	Oil Filter Full Flow.....	C-6202	Air Filter Secondary.....	A-5610
Air Filter Set.....	A-5655-S			Air Filter Primary.....	A-5614
Air Filter Secondary.....	A-5617	<b>D31S-16</b> (DOZERS) 4D92		Fuel Filter.....	FC-5602
Fuel Filter.....	FC-5605	Air Filter Primary.....	A-5616	Hydraulic Oil Filter.....	H-5606
Hydraulic Oil Filter.....	HC-5601	Air Filter Set.....	A-5655-S	Oil Filter Full Flow.....	C-5715
Oil Filter Full Flow.....	C-6202	Air Filter Secondary.....	A-5617	Oil Filter By Pass.....	O-5704
		Fuel Filter.....	FC-5605	Oil Filter Full Flow.....	C-5605
<b>D31Q-17</b> (DOZERS) 4D105/32001		Hydraulic Oil Filter.....	HC-5601	Oil Filter Full Flow.....	C-5701
Air Filter Secondary.....	A-7806	Oil Filter Full Flow.....	C-6202		
Air Filter Primary.....	AS-7805			<b>D355A</b> (DOZERS) S6D155-4	
Fuel Filter.....	FC-5604	<b>D31S-17</b> (DOZERS) 4D105/32001		Air Filter Primary.....	A-5618
Hydraulic Oil Filter.....	HC-5602	Air Filter Secondary.....	A-7806	Air Filter Secondary.....	A-5610
Oil Filter Full Flow.....	C-5614	Air Filter Primary.....	AS-7805	Fuel Filter.....	FC-5602
		Fuel Filter.....	FC-5604	Fuel Filter.....	F-2604
<b>D31Q-18</b> (DOZERS) 6D95L-1/40001		Hydraulic Oil Filter.....	HC-5602	Fuel Filter.....	F-2626
Air Filter Primary.....	AS-7805	Oil Filter Full Flow.....	C-5614	Oil Filter Full Flow.....	C-5701
Air Filter Secondary.....	A-7806			Oil Filter Full Flow.....	O-5501
Fuel Filter.....	FC-5604	<b>D31PX-22</b> (DOZERS) KOMATSU SAA4D95LE-5 , 2011		Oil Filter By Pass.....	O-5704
Hydraulic Oil Filter.....	HC-5602	Air Filter Secondary.....	A-56741	Oil Filter Full Flow.....	O-5601
Oil Filter Full Flow.....	C-5604	Air Filter Primary.....	A-56731	Oil Filter Full Flow.....	C-5605
		Air Filter Set.....	A-56731-S	Oil Filter Full Flow.....	C-5715
<b>D31S</b> (DOZERS) 4D105					
Air Filter Secondary.....	A-5617	<b>D31PX-22</b> (DOZERS) SAA4D95LE-5 , 2011		<b>D355A-1</b> (DOZERS) S6D155	
Air Filter Set.....	A-5655-S	Air Filter Set.....	A-5675-S	Air Filter Primary.....	A-5618
Air Filter Primary.....	A-5616	Air Filter Primary.....	A-5673	Air Filter Secondary.....	A-5610
Hydraulic Oil Filter.....	H-5608	Air Filter Secondary.....	A-8670	Air Filter Primary.....	A-5614
		Oil Filter Full Flow.....	C-56191	Fuel Filter.....	F-2626
<b>D31S</b> (DOZERS) 4D105-1		Oil Filter Full Flow.....	C-56190	Hydraulic Oil Filter.....	H-5606
Air Filter Set.....	A-5655-S			Hydraulic Oil Filter.....	H-5609
Air Filter Primary.....	A-5616	<b>D31PX-22</b> (DOZERS) SAA4D95LE-5		Oil Filter Full Flow.....	O-5601
Air Filter Secondary.....	A-5617	Air Filter Breather.....	A-82010	Oil Filter By Pass.....	O-5704
Fuel Filter.....	FC-5605	Air Filter Secondary.....	A-5674		
Hydraulic Oil Filter.....	HC-5601			<b>D355A-3</b> (DOZERS) D355A-3	
Oil Filter Full Flow.....	C-6202	<b>D31EX-22</b> (DOZERS) KOMATSU SAA4D95LE-5 , 2011		Fuel Filter.....	FC-5610
		Air Filter Secondary.....	A-56741		
<b>D31S</b> (DOZERS) 4D92		Air Filter Primary.....	A-56731	<b>D355A-3</b> (DOZERS)	
Air Filter Set.....	A-5655-S	Air Filter Set.....	A-56731-S	Air Filter Primary.....	A-6113
Air Filter Primary.....	A-5616			Air Filter Secondary.....	A-5408
Air Filter Secondary.....	A-5617	<b>D31EX-22</b> (DOZERS) SAA4D95LE-5		Fuel/Water Separator Secondary..	SFC-5611-10B
Fuel Filter.....	FC-5605	Air Filter Breather.....	A-82010	Fuel/Water Separator Secondary..	SFC-5611-10
Hydraulic Oil Filter.....	HC-5601	Air Filter Secondary.....	A-5674	Hydraulic Oil Filter.....	H-5606
Oil Filter Full Flow.....	C-6202			Hydraulic Oil Filter.....	H-5609
		<b>D32E-1</b> (DOZERS) 4D102E		Oil Filter Full Flow.....	C-5715
<b>D31S-15</b> (DOZERS) 4D92		Fuel/Water Separator.....	SFC-5708	Oil Filter Full Flow.....	C-5701
Air Filter Set.....	A-5655-S	Hydraulic Oil Filter.....	HC-76080	Oil Filter Full Flow.....	C-5605
Air Filter Primary.....	A-5616				
Air Filter Secondary.....	A-5617	<b>D32P-1</b> (DOZERS) 4D102E		<b>D355A-3</b> (DOZERS) SA6D155/1632	
Hydraulic Oil Filter.....	H-5608	Fuel/Water Separator.....	SFC-5708	Air Filter Secondary.....	A-5610
Oil Filter Full Flow.....	C-5606	Hydraulic Oil Filter.....	HC-76080	Air Filter Primary.....	A-5614
				Fuel Filter.....	F-2604
<b>D31S-16</b> (DOZERS) 4D105-1		<b>D354</b> (DOZERS)		Fuel Filter.....	FC-5602
Air Filter Primary.....	A-5616	Air Filter Set.....	A-9219-S	Hydraulic Oil Filter.....	H-5606
Air Filter Set.....	A-5655-S	Air Filter Primary.....	A-9219	Hydraulic Oil Filter.....	H-5609
Air Filter Secondary.....	A-5617	Fuel Filter.....	FC-5103	Oil Filter By Pass.....	O-5704
Hydraulic Oil Filter.....	H-5608	Oil Filter Full Flow.....	O-1803	Oil Filter Full Flow.....	C-5715
Oil Filter Full Flow.....	C-5606			Oil Filter Full Flow.....	C-5701

MODEL/APPLICATION	SAKURA NO	MODEL/APPLICATION	SAKURA NO	MODEL/APPLICATION	SAKURA NO
<b>KOMATSU</b>		<b>KOMATSU</b>		<b>KOMATSU</b>	
D355A-3 (DOZERS) SA6D155/1632		D37-5 (DOZERS) S4D102E-1/3731		D375A-3 (DOZERS) SA6D170	
Oil Filter Full Flow.....	C-5605	Air Filter Primary.....	A-5627	Fuel Filter.....	FC-5606
D355A-3 (DOZERS) SA6D155		Air Filter Secondary.....	A-6008	<b>D375A-3</b> (DOZERS) SA6D170-1/17001	
Fuel Filter.....	FC-5606	Air Filter Set.....	A-5663-S	Air Filter Secondary.....	A-5610
D355A-5 (DOZERS) 12622		Fuel Filter Secondary.....	FC-7903	Air Filter Primary.....	A-5614
Air Filter Secondary.....	A-5610	Fuel/Water Separator.....	SFC-5708	Coolant Filter.....	WC-56010
Air Filter Primary.....	A-5614	Hydraulic Oil Filter.....	HC-5602	Coolant Filter.....	WC-6901
Fuel Filter.....	FC-5602	Oil Filter Full Flow.....	C-5703	Fuel Filter.....	FC-5602
Hydraulic Oil Filter.....	H-5609	<b>D375A</b> (DOZERS) SA6D170E-2A/17001/17353		Hydraulic Oil Filter.....	H-5609
Hydraulic Oil Filter.....	H-5606	Air Filter Secondary.....	A-5610	Oil Filter Full Flow.....	C-5701
Oil Filter Full Flow.....	C-5715	Air Filter Primary.....	A-5614	Oil Filter Full Flow.....	C-5715
Oil Filter Full Flow.....	C-5701	Coolant Filter.....	WC-56010	Oil Filter Full Flow.....	C-5605
Oil Filter Full Flow.....	C-5605	Hydraulic Oil Filter.....	H-5609	<b>D375A-3</b> (DOZERS) SA6D170E-2/17001	
D355A-5 (DOZERS) SA6D155		Oil Filter Full Flow.....	C-5715	Air Filter Secondary.....	A-5610
Fuel Filter.....	FC-5606	Oil Filter Full Flow.....	C-5701	Air Filter Primary.....	A-5614
D355C-3 (DOZERS) S6D155		Oil Filter Full Flow.....	C-5701	Coolant Filter.....	WC-6901
Fuel Filter.....	FC-5606	<b>D375A-1</b> (DOZERS) SA6D170		Coolant Filter.....	WC-56010
D355C-3 (DOZERS) S6D155-4/3259		Fuel Filter.....	FC-5606	Fuel Filter.....	FC-5602
Oil Filter Full Flow.....	C-5605	<b>D375A-1</b> (DOZERS) SA6D170E-2/15001		Hydraulic Oil Filter.....	H-5609
D355C-3 (PIPE LAYERS) KOMATSU S6D155-4 3259		Air Filter Secondary.....	A-5610	Oil Filter Full Flow.....	C-5605
Fuel Filter.....	FC-5610	Air Filter Primary.....	A-5614	Oil Filter Full Flow.....	C-5701
D355C-3 (PIPE LAYERS) S6D155-4/3259		Coolant Filter.....	WC-56010	Oil Filter Full Flow.....	C-5715
Air Filter Secondary.....	A-5610	Coolant Filter.....	WC-6901	<b>D375A-5</b> (DOZERS) KOMATSU SA6D170E-5DR	
Air Filter Primary.....	A-5614	Fuel Filter.....	FC-5602	Fuel/Water Separator.....	SFC-56020
Fuel Filter.....	FC-5602	Hydraulic Oil Filter.....	H-5609	Fuel/Water Separator.....	SFC-56020B
Hydraulic Oil Filter.....	H-5601	Oil Filter Full Flow.....	C-5701	<b>D375A-5</b> (DOZERS) SA6D170E	
Hydraulic Oil Filter.....	H-5608	Oil Filter Full Flow.....	C-5715	Air Filter Secondary.....	A-8580
Hydraulic Oil Filter.....	H-5606	Oil Filter Full Flow.....	C-5605	Air Filter Primary.....	A-8665M
Oil Filter Full Flow.....	C-5701	<b>D375A-2</b> (DOZERS) SA6D170		Hydraulic Oil Filter.....	H-5609
Oil Filter Full Flow.....	C-5715	Fuel Filter.....	FC-5606	Oil Filter Full Flow.....	C-5715
D37-2 (DOZERS) S/N: 1501		<b>D375A-2</b> (DOZERS) SA6D170-1/16001		Oil Filter Full Flow.....	C-5701
Air Filter Primary.....	AS-7805	Air Filter Secondary.....	A-5610	Oil Filter Full Flow.....	C-5605
Air Filter Secondary.....	A-7806	Air Filter Primary.....	A-5614	Oil Filter Full Flow.....	C-5715
Fuel Filter.....	FC-5604	Coolant Filter.....	WC-56010	<b>D375A-5</b> (DOZERS) SA6D170E-3	
Hydraulic Oil Filter.....	HC-5602	Coolant Filter.....	WC-6901	Air Filter Secondary.....	A-8580
Oil Filter Full Flow.....	C-5604	Fuel Filter.....	FC-5602	Air Filter Primary.....	A-8665M
D375 (DOZERS) 2006		Hydraulic Oil Filter.....	H-5609	Hydraulic Oil Filter.....	H-5609
Cabin Air Filter Set.....	CA-5601-S	Oil Filter Full Flow.....	C-5715	Oil Filter Full Flow.....	C-5701
Cabin Air Filter.....	CA-56041	Oil Filter Full Flow.....	C-5605	Oil Filter Full Flow.....	C-5605
D37-5 (DOZERS) 6D95L-1/3001/3730/100413		Oil Filter Full Flow.....	C-5701	Oil Filter Full Flow.....	C-5715
Air Filter Primary.....	AS-7805	<b>D375A-2</b> (DOZERS) SA6D170E-2/16001		<b>D375A-5E0</b> (DOZERS) SAA6D170E-5 , 2005	
Air Filter Secondary.....	A-7806	Air Filter Secondary.....	A-5610	Air Filter Primary.....	A-8665M
Fuel Filter.....	FC-1801	Air Filter Primary.....	A-5614	Air Filter Secondary.....	A-8580
Oil Filter Full Flow.....	C-5604	Coolant Filter.....	WC-56010	Cabin Air Filter Set.....	CA-5601-S
D375A-3 (DOZERS) SA6D170E-5		Coolant Filter.....	WC-6901	Cabin Air Filter.....	CA-56041
Fuel/Water Separator.....	SFC-56020	Fuel Filter.....	FC-5602	Coolant Filter.....	WC-56010
Fuel/Water Separator.....	SFC-5611-10B	Hydraulic Oil Filter.....	H-5609	Fuel/Water Separator Secondary..	SFC-5611-10
<b>D375A-5E0</b> (DOZERS) KOMATSU SA6D170E-5		Oil Filter Full Flow.....	C-5715	Fuel/Water Separator Secondary..	SFC-5611-10B
Fuel/Water Separator.....	SFC-56020	Oil Filter Full Flow.....	C-5605	<b>D375A-5E0</b> (DOZERS) KOMATSU SA6D170E-5	
		Oil Filter Full Flow.....	C-5701	Fuel/Water Separator.....	SFC-56020

MODEL/APPLICATION	SAKURA NO	MODEL/APPLICATION	SAKURA NO	MODEL/APPLICATION	SAKURA NO
<b>KOMATSU</b>		<b>KOMATSU</b>		<b>KOMATSU</b>	
<b>D375A-5EO</b> (DOZERS) KOMATSU SA6D170E-5 Fuel/Water Separator.....	SFC-56020B	Oil Filter Full Flow.....	C-5614	Fuel Filter Secondary.....	FC-7903
<b>D375A-5SL</b> (DOZERS) SA6D170E Air Filter Secondary.....	A-8580	<b>D37P-2</b> (DOZERS) 6D95L-1/1501 Air Filter Secondary.....	A-7806	Fuel/Water Separator.....	SFC-5708
Air Filter Primary.....	A-8665M	Air Filter Primary.....	AS-7805	Hydraulic Oil Filter.....	HC-5602
Hydraulic Oil Filter.....	H-5609	Fuel Filter.....	FC-5604	Oil Filter Full Flow.....	C-5405
Oil Filter Full Flow.....	C-5701	Hydraulic Oil Filter.....	HC-5602	<b>D37EX-21A</b> (DOZERS) SAA4D102E-2C Air Filter Secondary.....	A-5674
Oil Filter Full Flow.....	C-5715	Oil Filter Full Flow.....	C-5604	Cabin Air Filter.....	CA-56070
Oil Filter Full Flow.....	C-5605	<b>D37PX-22</b> (DOZERS) KOMATSU SAA4D95LE-5 Air Filter Primary.....	A-56731	<b>D37PX-21A</b> (DOZERS) SAA4D102E-2C Air Filter Secondary.....	A-5674
<b>D37-E</b> (DOZERS) Air Filter Primary.....	AS-7805	Air Filter Set.....	A-56731-S	Cabin Air Filter.....	CA-56070
Air Filter Secondary.....	A-7806	Air Filter Secondary.....	A-56741	<b>D375A-6</b> (DOZERS) KOMATSU SAA6D170E-5 Fuel Filter.....	FC-5614
Fuel Filter.....	FC-1801	<b>D37PX-22</b> (DOZERS) SAA4D95LE-5 Air Filter Set.....	A-5675-S	Fuel Filter.....	FC-56300
Oil Filter Full Flow.....	C-5604	Air Filter Secondary.....	A-5674	Fuel Filter.....	FC-56230
<b>D37E-1</b> (DOZERS) 4D105/10001 Air Filter Primary.....	AS-7805	Air Filter Breather.....	A-82010	<b>D38E-1</b> (DOZERS) S4D102E Air Filter Secondary.....	A-7964
Air Filter Secondary.....	A-7806	Air Filter Secondary.....	A-8670	Air Filter Primary.....	AS-7805
Fuel Filter.....	FC-5604	Air Filter Primary.....	A-5673	Fuel/Water Separator.....	SFC-5708
Hydraulic Oil Filter.....	HC-5602	Oil Filter Full Flow.....	C-56190	Hydraulic Oil Filter.....	HC-76080
Oil Filter Full Flow.....	C-5614	Oil Filter Full Flow.....	C-56191	<b>D38E-1A</b> (DOZERS) S4D102E Air Filter Secondary.....	A-7964
<b>D37E-2</b> (DOZERS) 6D95L-1/1501 Air Filter Primary.....	AS-7805	<b>D37EX-21</b> (DOZERS) SAA4D102E Air Filter Primary.....	A-5673	Air Filter Primary.....	AS-7805
Air Filter Secondary.....	A-7806	Air Filter Set.....	A-5675-S	Fuel/Water Separator.....	SFC-5708
Fuel Filter.....	FC-5604	Air Filter Secondary.....	A-8670	Hydraulic Oil Filter.....	HC-76080
Hydraulic Oil Filter.....	HC-5602	Cabin Air Filter.....	CA-56041	<b>D38P-1A</b> (DOZERS) S4D102E Air Filter Secondary.....	A-7964
Oil Filter Full Flow.....	C-5604	Fuel Filter.....	F-5218	Air Filter Primary.....	AS-7805
<b>D37E-5</b> (DOZERS) 6D95L-1 Air Filter Primary.....	AS-7805	<b>D37EX-21</b> (DOZERS) SAA4D102E-2C Air Filter Secondary.....	A-5674	Fuel/Water Separator.....	SFC-5708
Air Filter Secondary.....	A-7806	Cabin Air Filter.....	CA-56070	Hydraulic Oil Filter.....	HC-76080
Fuel Filter.....	FC-1801	<b>D37PX-21</b> (DOZERS) KOMATSU SAA4D102E Air Filter Secondary.....	A-56741	<b>D39E-1</b> (DOZERS) S4D102E Air Filter Primary.....	AS-7805
Oil Filter Full Flow.....	C-5405	Air Filter Primary.....	A-56731	Air Filter Secondary.....	A-7964
<b>D37EX-22</b> (DOZERS) KOMATSU SAA4D95LE-5 Air Filter Secondary.....	A-56741	Air Filter Set.....	A-5675-S	Fuel/Water Separator.....	SFC-5708
Air Filter Primary.....	A-56731	Air Filter Primary.....	A-5673	Hydraulic Oil Filter.....	HC-76080
Air Filter Set.....	A-56731-S	Air Filter Secondary.....	A-8670	<b>D39E-1A</b> (DOZERS) S4D102E Air Filter Secondary.....	A-7964
<b>D37EX-22</b> (DOZERS) SAA4D95LE-5 Air Filter Breather.....	A-82010	Cabin Air Filter.....	CA-56041	Air Filter Primary.....	AS-7805
Air Filter Secondary.....	A-5674	Fuel Filter.....	F-5218	Fuel/Water Separator.....	SFC-5708
Air Filter Set.....	A-5675-S	<b>D37PX-21</b> (DOZERS) SAA4D102E-2C Air Filter Secondary.....	A-5674	Hydraulic Oil Filter.....	HC-76080
Air Filter Primary.....	A-5673	Cabin Air Filter.....	CA-56070	<b>D39EX-21</b> (DOZERS) SAA4D102E Air Filter Primary.....	A-5673
Air Filter Secondary.....	A-8670	<b>D37A-5</b> (DOZERS) 6D95L-1AD , 2012 Air Filter Secondary.....	A-7806	Air Filter Secondary.....	A-5674
Oil Filter Full Flow.....	C-56190	Air Filter Primary.....	AS-7805	Air Filter Secondary.....	A-8670
Oil Filter Full Flow.....	C-56191	Air Filter Primary.....	A-5627	Air Filter Set.....	A-5675-S
<b>D37P-1</b> (DOZERS) 4D105/10001 Air Filter Primary.....	AS-7805	Air Filter Secondary.....	A-6008	Cabin Air Filter.....	CA-56070
Air Filter Secondary.....	A-7806	Air Filter Set.....	A-5663-S	Fuel Filter Secondary.....	FC-7903
Fuel Filter.....	FC-5604	Fuel Filter.....	FC-1801	Fuel/Water Separator.....	SFC-5708
Hydraulic Oil Filter.....	HC-5602			Hydraulic Oil Filter.....	HC-5602

MODEL/APPLICATION	SAKURA NO	MODEL/APPLICATION	SAKURA NO	MODEL/APPLICATION	SAKURA NO
<b>KOMATSU</b>		<b>KOMATSU</b>		<b>KOMATSU</b>	
<b>D39EX-21A</b> (DOZERS) SAA4D102E		Fuel Filter.....	F-5218	Fuel Filter.....	FC-5605
Air Filter Secondary.....	A-5674	<b>D40-3</b> (DOZERS) 6001		Hydraulic Oil Filter.....	H-5608
Air Filter Secondary.....	A-8670	Air Filter Primary.....	AS-1024	Hydraulic Oil Filter.....	H-5611
Air Filter Set.....	A-5675-S	Air Filter Set.....	AS-1024-S	Oil Filter Full Flow.....	C-6202
Air Filter Primary.....	A-5673	Air Filter Secondary.....	A-6009	Oil Filter Full Flow.....	C-5606
Cabin Air Filter.....	CA-56041	Hydraulic Oil Filter.....	H-5607		
Cabin Air Filter.....	CA-56070	Oil Filter Full Flow.....	C-5614	<b>D40PL-3</b> (DOZERS) 6D105	
Fuel Filter.....	F-5218			Air Filter Primary.....	AS-1024
<b>D39EX-22</b> (DOZERS) SAA4D107E-1		<b>D40A</b> (DOZERS) S4D105-3		Air Filter Set.....	AS-1024-S
Air Filter Primary.....	A-8577	Fuel Filter.....	FC-5605	Coolant Filter.....	WC-5707
Air Filter Secondary.....	A-8578	Hydraulic Oil Filter.....	H-5608	Fuel Filter.....	FC-5621
Air Filter Breather.....	A-82010	Hydraulic Oil Filter.....	H-5611	Hydraulic Oil Filter.....	H-5607
Fuel Filter.....	FC-5613	Oil Filter Full Flow.....	C-6202	Oil Filter Full Flow.....	C-5614
Oil Filter Full Flow.....	C-5611	Oil Filter Full Flow.....	C-5606		
<b>D39P-1</b> (DOZERS) S4D102E		<b>D40A-3</b> (DOZERS) 6D105		<b>D40PLL-1</b> (DOZERS) S4D105/1501	
Air Filter Primary.....	AS-7805	Air Filter Primary.....	AS-1024	Hydraulic Oil Filter.....	H-5611
Air Filter Secondary.....	A-7964	Air Filter Set.....	AS-1024-S	Hydraulic Oil Filter.....	H-5608
Fuel/Water Separator.....	SFC-5708	Coolant Filter.....	WC-5707	Oil Filter Full Flow.....	C-5606
Hydraulic Oil Filter.....	HC-76080	Fuel Filter.....	FC-5621		
<b>D39P-1A</b> (DOZERS) S4D102E		Hydraulic Oil Filter.....	H-5607	<b>D40PLL-3</b> (DOZERS) 6D105	
Air Filter Primary.....	AS-7805	Oil Filter Full Flow.....	C-5614	Air Filter Primary.....	AS-1024
Air Filter Secondary.....	A-7964			Air Filter Set.....	AS-1024-S
Fuel/Water Separator.....	SFC-5708	<b>D40P</b> (DOZERS) S4D105-3		Coolant Filter.....	WC-5707
Hydraulic Oil Filter.....	HC-76080	Fuel Filter.....	FC-5605	Fuel Filter.....	FC-5621
<b>D39PX-1</b> (DOZERS) S4D102E		Hydraulic Oil Filter.....	H-5608	Hydraulic Oil Filter.....	H-5607
Air Filter Primary.....	AS-7805	Hydraulic Oil Filter.....	H-5611	Oil Filter Full Flow.....	C-5614
Air Filter Secondary.....	A-7964	Oil Filter Full Flow.....	C-5606		
Fuel/Water Separator.....	SFC-5708	Oil Filter Full Flow.....	C-6202	<b>D41-3</b> (DOZERS) S/N: 6001	
Hydraulic Oil Filter.....	HC-76080			Air Filter Secondary.....	A-6009
<b>D39PX-1A</b> (DOZERS) S4D102E		<b>D40P-1</b> (DOZERS) S4D105/1501		Air Filter Primary.....	AS-1024
Air Filter Primary.....	AS-7805	Hydraulic Oil Filter.....	H-5611	Air Filter Set.....	AS-1024-S
Air Filter Secondary.....	A-7964	Hydraulic Oil Filter.....	H-5608	Hydraulic Oil Filter.....	H-5607
Fuel/Water Separator.....	SFC-5708	Oil Filter Full Flow.....	C-5606	Oil Filter Full Flow.....	C-5614
Hydraulic Oil Filter.....	HC-76080	Oil Filter Full Flow.....	C-6202		
<b>D39PX-21</b> (DOZERS) SAA4D102E		<b>D40P-1</b> (DOZERS) S4D105-3		<b>D41A-3</b> (DOZERS) 6D105-1	
Air Filter Secondary.....	A-56741	Fuel Filter.....	FC-5605	Air Filter Primary.....	AS-1024
Air Filter Primary.....	A-56731	Hydraulic Oil Filter.....	H-5611	Air Filter Set.....	AS-1024-S
Air Filter Set.....	A-56731-S	Hydraulic Oil Filter.....	H-5608	Coolant Filter.....	WC-5707
<b>D39PX-21A</b> (DOZERS) SAA4D102E		Hydraulic Oil Filter.....	H-5607	Fuel Filter.....	FC-5621
Air Filter Secondary.....	A-56741	Oil Filter Full Flow.....	C-5606	Hydraulic Oil Filter.....	H-5607
Cabin Air Filter.....	CA-56070	Oil Filter Full Flow.....	C-6202	Oil Filter Full Flow.....	C-5614
<b>D39PX-22</b> (DOZERS) SAA4D107E-1		<b>D40P-3</b> (DOZERS) 6D105		<b>D41A-6</b> (DOZERS) 6D102-1/B20001	
Air Filter Secondary.....	A-8578	Air Filter Primary.....	AS-1024	Air Filter Primary.....	A-5627
Air Filter Primary.....	A-8577	Air Filter Set.....	AS-1024-S	Air Filter Secondary.....	A-6008
Air Filter Breather.....	A-82010	Coolant Filter.....	WC-5707	Air Filter Set.....	A-5663-S
Fuel Filter.....	FC-5613	Fuel Filter.....	FC-5621	Fuel Filter Secondary.....	FC-7903
Oil Filter Full Flow.....	C-5611	Hydraulic Oil Filter.....	H-5607	Fuel/Water Separator.....	SFC-5708
<b>D39PX-21A</b> (DOZERS) SAA4D102E		Hydraulic Oil Filter.....	H-5607	Hydraulic Oil Filter.....	HC-5602
Air Filter Secondary.....	A-56741	Oil Filter Full Flow.....	C-5614	Oil Filter Full Flow.....	C-5730
Air Filter Primary.....	A-56731	<b>D40PL-1</b> (DOZERS) S4D105/1501		<b>D41E-6</b> (DOZERS) S6D102E-1/B20001	
Air Filter Set.....	A-56731-S	Hydraulic Oil Filter.....	H-5608	Air Filter Primary.....	A-5627
<b>D39PX-21A</b> (DOZERS) SAA4D102E		Hydraulic Oil Filter.....	H-5611	Air Filter Secondary.....	A-6008
Air Filter Secondary.....	A-56741	Oil Filter Full Flow.....	C-5606	Air Filter Set.....	A-5663-S
Air Filter Set.....	A-5675-S			Fuel Filter Secondary.....	FC-7903
Air Filter Primary.....	A-5673	<b>D40PL-1</b> (DOZERS) S4D105-3		Fuel/Water Separator.....	SFC-5708
Air Filter Secondary.....	A-8670	Hydraulic Oil Filter.....	H-5607	Hydraulic Oil Filter.....	HC-5602
Cabin Air Filter.....	CA-56070	Oil Filter Full Flow.....	C-5614	Oil Filter Full Flow.....	C-5730
Cabin Air Filter.....	CA-56041			<b>D41E-6</b> (DOZERS) S6D102E-1/B20001	
		Hydraulic Oil Filter.....	H-5608	Air Filter Primary.....	A-5627
		Hydraulic Oil Filter.....	H-5611	Air Filter Secondary.....	A-6008
		Oil Filter Full Flow.....	C-5606	Air Filter Set.....	A-5663-S
				Fuel Filter Secondary.....	FC-7903
				Fuel/Water Separator.....	SFC-5708
				Hydraulic Oil Filter.....	HC-5602
				Oil Filter Full Flow.....	C-5730

# Sakura Filter

# ENGINE APPLICATION

MODEL/APPLICATION	SAKURA NO	MODEL/APPLICATION	SAKURA NO	MODEL/APPLICATION	SAKURA NO
<b>KOMATSU</b>		<b>KOMATSU</b>		<b>KOMATSU</b>	
D41E-6 (DOZERS) S6D102E-1/B20001 Oil Filter Full Flow.....	C-5730	Hydraulic Oil Filter.....	H-5607	Oil Filter Full Flow.....	C-5606
D41-P (DOZERS)		Hydraulic Oil Filter.....	H-5622	<b>D45P-1</b> (DOZERS) S4D105-3	
Air Filter Primary.....	AS-1024	Hydraulic Oil Filter.....	H-5609	Fuel Filter.....	FC-5605
Air Filter Set.....	AS-1024-S	Oil Filter By Pass.....	0-5704	Hydraulic Oil Filter.....	H-5608
Air Filter Secondary.....	A-6009	Oil Filter Full Flow.....	0-5702	Hydraulic Oil Filter.....	H-5611
Coolant Filter.....	WC-5705	<b>D445A-1</b> (DOZERS) w/Cummins VTA1710-1B Eng		Oil Filter Full Flow.....	C-5606
Fuel Filter.....	FC-5605	Hydraulic Oil Filter.....	H-5519	Oil Filter Full Flow.....	C-6202
Hydraulic Oil Filter.....	H-5607	<b>D455A</b> (DOZERS) CUMMINS		<b>D455-1</b> (DOZERS) S4D105/1501	
Oil Filter Full Flow.....	C-5614	Air Filter Secondary.....	A-5610	Hydraulic Oil Filter.....	H-5607
<b>D41P-3</b> (DOZERS) 6D105-1		Air Filter Primary.....	A-5614	Hydraulic Oil Filter.....	H-5611
Air Filter Primary.....	AS-1024	Air Filter Primary.....	A-5618	Oil Filter Full Flow.....	C-5606
Air Filter Set.....	AS-1024-S	Fuel Filter.....	FC-5703	<b>D455-1</b> (DOZERS) S4D105-3	
Coolant Filter.....	WC-5707	Fuel Filter.....	F-5601	Fuel Filter.....	FC-5605
Fuel Filter.....	FC-5621	Fuel/Water Separator.....	SFC-5707	Hydraulic Oil Filter.....	H-5607
Hydraulic Oil Filter.....	H-5607	Oil Filter Full Flow.....	0-5702	Hydraulic Oil Filter.....	H-5611
Oil Filter Full Flow.....	C-5614	Oil Filter By Pass.....	0-5704	Hydraulic Oil Filter.....	H-5611
<b>D41P-6</b> (DOZERS) 6D102-1/B20001		<b>D455A</b> (DOZERS) w/Cummins VTA1710-1B Eng		Oil Filter Full Flow.....	C-5606
Air Filter Primary.....	A-5627	Hydraulic Oil Filter.....	H-5519	Oil Filter Full Flow.....	C-6202
Air Filter Secondary.....	A-6008	<b>D455A-1</b> (DOZERS) VTA-1710/1001		<b>D455</b> (DOZERS) w/Cummins VTA1710-1B Eng	
Air Filter Set.....	A-5663-S	Air Filter Secondary.....	A-5610	Hydraulic Oil Filter.....	H-5519
Fuel Filter Secondary.....	FC-7903	Air Filter Primary.....	A-5614	<b>D455-1</b> (DOZERS) w/Cummins VTA1710-1B Eng	
Fuel/Water Separator.....	SFC-5708	Fuel Filter.....	F-5601	Hydraulic Oil Filter.....	H-5519
Hydraulic Oil Filter.....	HC-5602	Fuel Filter.....	FC-5703	<b>D475</b> (DOZERS) SA12V140	
Oil Filter Full Flow.....	C-5730	Fuel/Water Separator.....	SFC-5707	Air Filter Secondary.....	A-5610
<b>D41Q-3</b> (LOADERS) 6D105-1		Hydraulic Oil Filter.....	H-5607	Air Filter Primary.....	A-5614
Air Filter Primary.....	AS-1024	Hydraulic Oil Filter.....	H-5622	Coolant Filter.....	WC-6901
Air Filter Set.....	AS-1024-S	Hydraulic Oil Filter.....	H-5609	Fuel Filter.....	FC-5703
Coolant Filter.....	WC-5707	Oil Filter Full Flow.....	0-5702	Fuel/Water Separator.....	SFC-5707
Fuel Filter.....	FC-5621	Oil Filter By Pass.....	0-5704	Oil Filter Full Flow.....	C-5605
Hydraulic Oil Filter.....	H-5607	<b>D455A-1</b> (DOZERS) w/Cummins VTA1710-1B Eng		Oil Filter Full Flow.....	C-5701
Oil Filter Full Flow.....	C-5614	Hydraulic Oil Filter.....	H-5519	Oil Filter Full Flow.....	C-5715
<b>D41S-3</b> (LOADERS) 6D105-1		<b>D45A</b> (DOZERS) S4D105-3		<b>D475</b> (DOZERS) SA8V170	
Air Filter Primary.....	AS-1024	Fuel Filter.....	FC-5605	Air Filter Primary.....	A-5614
Air Filter Set.....	AS-1024-S	Hydraulic Oil Filter.....	H-5611	Air Filter Secondary.....	A-5610
Coolant Filter.....	WC-5707	Hydraulic Oil Filter.....	H-5608	Coolant Filter.....	WC-5708
Fuel Filter.....	FC-5621	Oil Filter Full Flow.....	C-5606	Fuel Filter.....	FC-5703
Hydraulic Oil Filter.....	H-5607	Oil Filter Full Flow.....	C-6202	Fuel/Water Separator.....	SFC-5707
Oil Filter Full Flow.....	C-5614	<b>D45A-1</b> (DOZERS) S4D105/1501		Hydraulic Oil Filter.....	H-7911
<b>D444</b> (LOADERS)		Hydraulic Oil Filter.....	H-5608	Hydraulic Oil Filter.....	H-85680
Air Filter Primary.....	A-9219	Hydraulic Oil Filter.....	H-5611	Oil Filter Full Flow.....	C-5605
Air Filter Set.....	A-9219-S	Oil Filter Full Flow.....	C-5606	Oil Filter Full Flow.....	C-5701
Fuel Filter.....	FC-5103	<b>D45E-1</b> (DOZERS) S4D105/1501		Oil Filter Full Flow.....	C-5715
Oil Filter Full Flow.....	0-1803	Hydraulic Oil Filter.....	H-5608	<b>D475A-1</b> (DOZERS) SA8V170-1/10001	
<b>D445A-1</b> (DOZERS) VTA-1710		Hydraulic Oil Filter.....	H-5611	Fuel Filter.....	FC-5703
Air Filter Secondary.....	A-5610	Oil Filter Full Flow.....	C-5606	Fuel/Water Separator.....	SFC-5707
Air Filter Primary.....	A-5614	<b>D45P-1</b> (DOZERS) S4D105/1501		Hydraulic Oil Filter.....	H-7911
Fuel Filter.....	F-5601	Hydraulic Oil Filter.....	H-5608	Hydraulic Oil Filter.....	H-85680
Fuel Filter.....	FC-5703	Hydraulic Oil Filter.....	H-5611	Oil Filter Full Flow.....	C-5605
Fuel/Water Separator.....	SFC-5707	Oil Filter Full Flow.....	C-5606	Oil Filter Full Flow.....	C-5701
				Oil Filter Full Flow.....	C-5715



MODEL/APPLICATION	SAKURA NO	MODEL/APPLICATION	SAKURA NO	MODEL/APPLICATION	SAKURA NO
<b>KOMATSU</b>		<b>KOMATSU</b>		<b>KOMATSU</b>	
<b>D475A-2</b> (DOZERS) SA12V140-1/10201		Oil Filter Full Flow.....	0-6503	<b>D50A-16</b> (DOZERS) 4D130	
Air Filter Secondary.....	A-5610	<b>D500</b> (DOZERS) VTA28-C		Fuel Filter.....	FC-5606
Air Filter Primary.....	A-5614	Fuel Filter.....	FC-5720	<b>D50A-16</b> (DOZERS) 4D130/65001	
Coolant Filter.....	WC-56010	Fuel Filter.....	FC-1303	Air Filter Primary.....	A-5602
Fuel Filter.....	FC-5703	Fuel Filter.....	F-5701	Air Filter Secondary.....	A-5603
Fuel/Water Separator.....	SFC-5707	Fuel/Water Separator.....	SFC-5705	Air Filter Set.....	A-5601-S
Hydraulic Oil Filter.....	H-7911	Hydraulic Oil Filter Transmission...	H-65030	Fuel Filter.....	FC-5602
Hydraulic Oil Filter.....	H-85680	Oil Filter Full Flow.....	0-5702	Fuel Filter.....	F-2626
Oil Filter Full Flow.....	C-5701	Oil Filter Full Flow.....	C-8031	Hydraulic Oil Filter.....	H-5608
Oil Filter By Pass.....	C-5718	<b>D50-17</b> (DOZERS) 6D125/80001		Oil Filter Full Flow.....	0-5601
Oil Filter Full Flow.....	C-5715	Air Filter Secondary.....	A-5603	Oil Filter Full Flow.....	C-5614
Oil Filter Full Flow.....	C-5605	Air Filter Set.....	A-5601-S	<b>D50A-17</b> (DOZERS) 6D125	
<b>D475A-5</b> (DOZERS) 2007		Air Filter Primary.....	A-5602	Fuel Filter.....	FC-5606
Cabin Air Filter.....	CA-5602	Fuel Filter.....	FC-5602	<b>D50A-17</b> (DOZERS) 6D125/80001	
Cabin Air Filter.....	CA-56041	Hydraulic Oil Filter.....	H-5608	Air Filter Secondary.....	A-5603
Fuel/Water Separator Secondary..	SFC-5611-10	Hydraulic Oil Filter.....	H-5611	Air Filter Primary.....	A-5602
Fuel/Water Separator Secondary..	SFC-5611-10B	Oil Filter Full Flow.....	C-5614	Air Filter Set.....	A-5601-S
Hydraulic Oil Filter.....	H-5639	<b>D50A</b> (DOZERS) 4D105-5		Fuel Filter.....	FC-5602
<b>D475A-5</b> (DOZERS) SDA12V140E		Air Filter Set.....	A-5657-S	Hydraulic Oil Filter.....	H-5608
Air Filter Primary.....	A-8665M	Air Filter Primary.....	A-5649	Hydraulic Oil Filter.....	H-5611
Air Filter Secondary.....	A-8580	Fuel Filter.....	F-2626	Oil Filter Full Flow.....	C-5614
Cabin Air Filter.....	CA-5602	Hydraulic Oil Filter.....	H-5526	<b>D50P-15</b> (DOZERS) 4D105-5	
Cabin Air Filter.....	CA-56041	Hydraulic Oil Filter.....	H-5608	Air Filter Set.....	A-5657-S
Fuel Filter.....	FC-5703	Hydraulic Oil Filter.....	H-5503	Air Filter Primary.....	A-5649
Fuel/Water Separator.....	SFC-5707	Hydraulic Oil Filter.....	H-55280	Fuel Filter.....	F-2626
Hydraulic Oil Filter.....	H-5609	Oil Filter Full Flow.....	0-5601	Hydraulic Oil Filter.....	H-5608
Hydraulic Breather.....	H-56610	<b>D50A</b> (DOZERS) 4D130/65001		Hydraulic Oil Filter.....	H-5526
<b>D475A-5E0</b> (DOZERS) SAA12V140E-3		Air Filter Primary.....	A-5602	Hydraulic Oil Filter.....	H-55280
Air Filter Secondary.....	A-8580	Air Filter Set.....	A-5601-S	Hydraulic Oil Filter.....	H-5503
Air Filter Primary.....	A-8665M	Air Filter Secondary.....	A-5603	Hydraulic Oil Filter.....	H-5503
Cabin Air Filter.....	CA-56041	Fuel Filter.....	FC-5602	Oil Filter Full Flow.....	0-5601
Cabin Air Filter.....	CA-5602	Fuel Filter.....	F-2626	<b>D50P-15</b> (DOZERS) 4D120	
Coolant Filter.....	WC-56010	Oil Filter Full Flow.....	C-5614	Air Filter Set.....	A-5657-S
Fuel/Water Separator Secondary..	SFC-5611-10	Oil Filter Full Flow.....	0-5601	Air Filter Primary.....	A-5649
Fuel/Water Separator Secondary..	SFC-5611-10B	<b>D50A-15</b> (DOZERS) 4D105-5		Fuel Filter.....	F-2626
Hydraulic Oil Filter.....	H-5609	Air Filter Set.....	A-5657-S	Hydraulic Oil Filter.....	H-5608
<b>D475ASD-5E0</b> (DOZERS) SAA12V140E-3		Air Filter Primary.....	A-5649	Hydraulic Oil Filter.....	H-5526
Air Filter Primary.....	A-8665M	Fuel Filter.....	F-2626	Hydraulic Oil Filter.....	H-55280
Air Filter Secondary.....	A-8580	Hydraulic Oil Filter.....	H-5503	Hydraulic Oil Filter.....	H-5503
Cabin Air Filter.....	CA-56041	Hydraulic Oil Filter.....	H-5608	Oil Filter Full Flow.....	0-5601
Cabin Air Filter.....	CA-5602	Hydraulic Oil Filter.....	H-55280	<b>D50P-16</b> (DOZERS) 4D130	
Coolant Filter.....	WC-56010	Hydraulic Oil Filter.....	H-5526	Fuel Filter.....	FC-5606
Fuel/Water Separator Secondary..	SFC-5611-10	Oil Filter Full Flow.....	0-5601	<b>D50P-16</b> (DOZERS) 4D130/65001	
Fuel/Water Separator Secondary..	SFC-5611-10B	<b>D50A-15</b> (DOZERS) 4D120		Air Filter Secondary.....	A-5603
Hydraulic Oil Filter.....	H-5609	Air Filter Set.....	A-5657-S	Air Filter Primary.....	A-5602
<b>D475A-3</b> (DOZERS) KOMATSU SDA12V140 , 1999-2004		Air Filter Primary.....	A-5649	Air Filter Set.....	A-5601-S
Oil Filter By Pass.....	C-5718	Fuel Filter.....	F-2626	Fuel Filter.....	FC-5602
<b>D500</b> (DOZERS) 16V-71		Hydraulic Oil Filter.....	H-5503	Fuel Filter.....	F-2626
Air Filter.....	A-8545	Hydraulic Oil Filter.....	H-5608	Hydraulic Oil Filter.....	H-5608
Fuel Filter.....	F-6504	Hydraulic Oil Filter.....	H-55280	Oil Filter Full Flow.....	C-5614
Hydraulic Oil Filter Transmission...	H-65030	Hydraulic Oil Filter.....	H-5526	<b>D50P-16</b> (DOZERS) 4D130/65001	
		Oil Filter Full Flow.....	0-5601	Air Filter Secondary.....	A-5603
				Air Filter Primary.....	A-5602
				Air Filter Set.....	A-5601-S
				Fuel Filter.....	FC-5602
				Fuel Filter.....	F-2626
				Hydraulic Oil Filter.....	H-5608
				Oil Filter Full Flow.....	C-5614

# Sakura Filter

# ENGINE APPLICATION

MODEL/APPLICATION	SAKURA NO	MODEL/APPLICATION	SAKURA NO	MODEL/APPLICATION	SAKURA NO
<b>KOMATSU</b>		<b>KOMATSU</b>		<b>KOMATSU</b>	
D50P-16 (DOZERS) 4D130/65001 Oil Filter Full Flow.....	0-5601	Hydraulic Oil Filter.....	H-55280	D53A (DOZERS) 6D125 Air Filter Primary.....	A-5602
D50P-17 (DOZERS) 6D125 Fuel Filter.....	FC-5606	Hydraulic Oil Filter.....	H-5526	Air Filter Secondary.....	A-5603
D50P-17 (DOZERS) 6D125/80001 Air Filter Primary.....	A-5602	Hydraulic Oil Filter.....	H-5503	Fuel Filter.....	FC-5602
Air Filter Secondary.....	A-5603	Hydraulic Oil Filter.....	H-5608	Hydraulic Oil Filter.....	H-5608
Air Filter Set.....	A-5601-S	Oil Filter Full Flow.....	0-5601	Hydraulic Oil Filter.....	H-5611
Fuel Filter.....	FC-5602	D50S-16 (DOZERS) 4D130 Fuel Filter.....	FC-5606	Oil Filter Full Flow.....	C-5614
Hydraulic Oil Filter.....	H-5608	D50S-16 (DOZERS) 4D130/65001 Air Filter Primary.....	A-5602	D53A-15 (DOZERS) S4D120 Air Filter Set.....	A-5604-S
Hydraulic Oil Filter.....	H-5611	Air Filter Secondary.....	A-5603	Air Filter Primary.....	A-5605
Oil Filter Full Flow.....	C-5614	Air Filter Set.....	A-5601-S	Air Filter Secondary.....	A-5606
D50PL-16 (DOZERS) 4D130 Fuel Filter.....	FC-5606	Fuel Filter.....	F-2626	Fuel Filter.....	F-2626
D50PL-16 (DOZERS) 4D130/65001 Air Filter Set.....	A-5601-S	Fuel Filter.....	FC-5602	Hydraulic Oil Filter.....	H-5608
Air Filter Primary.....	A-5602	Hydraulic Oil Filter.....	H-5611	Hydraulic Oil Filter.....	H-5620
Air Filter Secondary.....	A-5603	Oil Filter Full Flow.....	0-5601	Hydraulic Oil Filter.....	H-5611
Fuel Filter.....	F-2626	Oil Filter Full Flow.....	C-5614	Oil Filter Full Flow.....	0-5601
Fuel Filter.....	FC-5602	D51EX-22 (DOZERS) SAA6D107E-1 , 2008 Air Filter Primary.....	A-71360	D53A-16 (DOZERS) 4D120 Air Filter Primary.....	A-5602
Hydraulic Oil Filter.....	H-5608	Hydraulic Oil Filter.....	HC-5602	Air Filter Secondary.....	A-5603
Oil Filter Full Flow.....	0-5601	Oil Filter Full Flow.....	C-5611	Air Filter Set.....	A-5601-S
Oil Filter Full Flow.....	C-5614	D51EX-22 (DOZERS) SAA6D107E-1 Fuel Filter.....	FC-5613	Coolant Filter.....	WC-5707
D50PL-17 (DOZERS) 6D125 Fuel Filter.....	FC-5606	D51PX-22 (DOZERS) SAA6D107E-1 , 2008 Air Filter Primary.....	A-71360	Fuel Filter.....	F-2626
D50PL-17 (DOZERS) 6D125/80001 Air Filter Secondary.....	A-5603	Hydraulic Oil Filter.....	HC-5602	Hydraulic Oil Filter.....	H-5608
Air Filter Primary.....	A-5602	Oil Filter Full Flow.....	C-5611	Hydraulic Oil Filter.....	H-5611
Air Filter Set.....	A-5601-S	D51PX-22 (DOZERS) SAA6D107E-1 Fuel Filter.....	FC-5613	Hydraulic Oil Filter.....	H-5608
Fuel Filter.....	FC-5602	D53A (DOZERS) 4D120 Air Filter Primary.....	A-5602	Hydraulic Oil Filter.....	H-5611
Hydraulic Oil Filter.....	H-5608	Air Filter Secondary.....	A-5603	Hydraulic Oil Filter.....	H-5608
Hydraulic Oil Filter.....	H-5611	Air Filter Set.....	A-5601-S	Oil Filter Full Flow.....	0-5601
Oil Filter Full Flow.....	C-5614	Coolant Filter.....	WC-5707	D53A-16 (DOZERS) 4D130/65001 Air Filter Primary.....	A-5602
D50S-15 (DOZERS) 4D120 Air Filter Primary.....	A-5649	Fuel Filter.....	F-2626	Air Filter Secondary.....	A-5603
Air Filter Set.....	A-5657-S	Hydraulic Oil Filter.....	H-5620	Fuel Filter.....	FC-5602
Fuel Filter.....	F-5601	Hydraulic Oil Filter.....	H-5608	Hydraulic Oil Filter.....	H-5608
Fuel Filter.....	F-2626	Hydraulic Oil Filter.....	H-5611	Hydraulic Oil Filter.....	H-5620
Hydraulic Oil Filter.....	H-55280	Oil Filter Full Flow.....	0-5601	Oil Filter Full Flow.....	C-5614
Hydraulic Oil Filter.....	H-5526	D53A (DOZERS) 4D130 Air Filter Secondary.....	A-5603	Oil Filter Full Flow.....	0-5601
Hydraulic Oil Filter.....	H-5503	Air Filter Primary.....	A-5602	D53A-17 (DOZERS) 6D125 Fuel Filter.....	FC-5606
Hydraulic Oil Filter.....	H-5608	Air Filter Set.....	A-5601-S	D53A-17 (DOZERS) 6D125/80001 Air Filter Secondary.....	A-5603
Oil Filter Full Flow.....	0-5601	Coolant Filter.....	WC-5707	Air Filter Primary.....	A-5602
D50S-15 (DOZERS) 4D120-11 Air Filter Primary.....	A-5649	Fuel Filter.....	F-2626	Fuel Filter.....	FC-5602
Air Filter Set.....	A-5657-S	Hydraulic Oil Filter.....	H-5620	Hydraulic Oil Filter.....	H-5608
Fuel Filter.....	F-2626	Hydraulic Oil Filter.....	H-5608	Hydraulic Oil Filter.....	H-5611
Fuel Filter.....	F-5601	Hydraulic Oil Filter.....	H-5611	Oil Filter Full Flow.....	0-5601
		Oil Filter Full Flow.....	0-5601		

# Sakura Filter

# ENGINE APPLICATION

MODEL/APPLICATION	SAKURA NO
<b>KOMATSU</b>	
<b>D53A-17</b> (DOZERS) 6D125/80001	
Hydraulic Oil Filter.....	H-5611
Hydraulic Oil Filter.....	H-5620
Oil Filter Full Flow.....	C-5614
<b>D53P-16</b> (DOZERS) 4D120	
Air Filter Set.....	A-5601-S
Air Filter Secondary.....	A-5603
Air Filter Primary.....	A-5602
Coolant Filter.....	WC-5707
Fuel Filter.....	F-2626
Hydraulic Oil Filter.....	H-5620
Hydraulic Oil Filter.....	H-5608
Hydraulic Oil Filter.....	H-5611
Oil Filter Full Flow.....	O-5601
<b>D53P-16</b> (DOZERS) 4D130	
Air Filter Set.....	A-5601-S
Air Filter Secondary.....	A-5603
Air Filter Primary.....	A-5602
Coolant Filter.....	WC-5707
Fuel Filter.....	F-2626
Fuel Filter.....	FC-5606
Hydraulic Oil Filter.....	H-5611
Hydraulic Oil Filter.....	H-5608
Hydraulic Oil Filter.....	H-5620
Oil Filter Full Flow.....	O-5601
<b>D53P-16</b> (DOZERS) 4D130/65001	
Air Filter Secondary.....	A-5603
Air Filter Primary.....	A-5602
Fuel Filter.....	FC-5602
Hydraulic Oil Filter.....	H-5620
Hydraulic Oil Filter.....	H-5608
Hydraulic Oil Filter.....	H-5611
Oil Filter Full Flow.....	O-5601
Oil Filter Full Flow.....	C-5614
<b>D53P-17</b> (DOZERS) 6D125	
Fuel Filter.....	FC-5606
<b>D53P-17</b> (DOZERS) 6D125/80001	
Air Filter Primary.....	A-5602
Air Filter Secondary.....	A-5603
Fuel Filter.....	FC-5602
Hydraulic Oil Filter.....	H-5620
Hydraulic Oil Filter.....	H-5608
Hydraulic Oil Filter.....	H-5611
Oil Filter Full Flow.....	C-5614
<b>D53S-15</b> (DOZERS) S4D120	
Air Filter Primary.....	A-5605
Air Filter Secondary.....	A-5606
Air Filter Set.....	A-5604-S
Fuel Filter.....	F-2626
Hydraulic Oil Filter.....	H-5620
Hydraulic Oil Filter.....	H-5608

MODEL/APPLICATION	SAKURA NO
<b>KOMATSU</b>	
Oil Filter Full Flow.....	O-5601
<b>D53S-16</b> (DOZERS) 4D120	
Air Filter Secondary.....	A-5603
Air Filter Set.....	A-5601-S
Air Filter Primary.....	A-5602
Fuel Filter.....	F-2626
Hydraulic Oil Filter.....	H-5610
Hydraulic Oil Filter.....	H-5600
Hydraulic Oil Filter.....	H-5620
Hydraulic Oil Filter.....	H-5611
Oil Filter Full Flow.....	O-5601
<b>D53S-16</b> (DOZERS) 4D130	
Air Filter Secondary.....	A-5603
Air Filter Primary.....	A-5602
Air Filter Set.....	A-5601-S
Fuel Filter.....	F-2626
Fuel Filter.....	FC-5606
Hydraulic Oil Filter.....	H-5611
Hydraulic Oil Filter.....	H-5600
Hydraulic Oil Filter.....	H-5610
Hydraulic Oil Filter.....	H-5620
Oil Filter Full Flow.....	O-5601
<b>D53S-16</b> (DOZERS) 4D130/65001	
Air Filter Primary.....	A-5602
Air Filter Secondary.....	A-5603
Fuel Filter.....	F-2626
Fuel Filter.....	FC-5602
Hydraulic Oil Filter.....	H-5620
Hydraulic Oil Filter.....	H-5610
Hydraulic Oil Filter.....	H-5600
Oil Filter Full Flow.....	C-5614
Oil Filter Full Flow.....	O-5601
<b>D53S-17</b> (DOZERS) 4D130/80001	
Air Filter Primary.....	A-5602
Air Filter Secondary.....	A-5603
Fuel Filter.....	FC-5602
Hydraulic Oil Filter.....	H-5600
Hydraulic Oil Filter.....	H-5611
Hydraulic Oil Filter.....	H-5620
Hydraulic Oil Filter.....	H-5610
Oil Filter Full Flow.....	C-5614
<b>D53S-17</b> (DOZERS) 4D130-1F	
Fuel Filter.....	FC-5606
<b>D55S</b> (DOZERS) CUMMINS	
Air Filter Secondary.....	A-5606
Air Filter Set.....	A-5604-S
Air Filter Primary.....	A-5605
Fuel Filter.....	F-5601
Hydraulic Oil Filter.....	H-55280
Hydraulic Oil Filter.....	H-5503
Hydraulic Oil Filter.....	H-5526
Oil Filter Full Flow.....	O-5601

MODEL/APPLICATION	SAKURA NO
<b>KOMATSU</b>	
Oil Filter Full Flow.....	O-5603
Oil Filter By Pass.....	O-5705
<b>D55S-2</b> (DOZERS)	
Hydraulic Oil Filter.....	H-5526
Hydraulic Oil Filter.....	H-5610
Hydraulic Oil Filter.....	H-55280
Hydraulic Oil Filter.....	H-5620
Hydraulic Oil Filter.....	H-5503
<b>D55S-3</b> (DOZERS) CUMMINS	
Air Filter Secondary.....	A-5606
Air Filter Primary.....	A-5605
Air Filter Set.....	A-5604-S
Fuel Filter.....	F-5601
Hydraulic Oil Filter.....	H-5600
Hydraulic Oil Filter.....	H-55280
Hydraulic Oil Filter.....	H-5503
Hydraulic Oil Filter.....	H-5526
Hydraulic Oil Filter.....	H-5610
Oil Filter By Pass.....	O-5705
Oil Filter Full Flow.....	O-5603
Oil Filter Full Flow.....	O-5601
<b>D55S-3</b> (DOZERS) S4D120	
Air Filter Set.....	A-5604-S
Air Filter Secondary.....	A-5606
Air Filter Primary.....	A-5605
Fuel Filter.....	F-2626
Hydraulic Oil Filter.....	H-5610
Hydraulic Oil Filter.....	H-5600
Hydraulic Oil Filter.....	H-5620
Oil Filter Full Flow.....	O-5601
<b>D570</b> (EXCAVATORS) SA12V170	
Fuel Filter.....	FC-5703
Fuel/Water Separator.....	SFC-5707
Oil Filter Full Flow.....	C-5605
Oil Filter Full Flow.....	C-5715
Oil Filter Full Flow.....	C-5701
Oil Filter By Pass.....	C-5718
<b>D57-1</b> (DOZERS)	
Fuel Filter.....	F-2626
Oil Filter Full Flow.....	O-5601
<b>D575A-2</b> (DOZERS) SA12V170-1/10001	
Air Filter Secondary.....	A-5610
Air Filter Primary.....	A-5614
Coolant Filter.....	WC-56010
Fuel Filter.....	FC-5703
Fuel/Water Separator.....	SFC-5707
Hydraulic Oil Filter.....	H-7911
Hydraulic Oil Filter.....	H-85680
Oil Filter By Pass.....	C-5718
Oil Filter Full Flow.....	C-5715
Oil Filter Full Flow.....	C-5701
Oil Filter Full Flow.....	C-5605

MODEL/APPLICATION	SAKURA NO
<b>KOMATSU</b>	
<b>D575A-3</b> (DOZERS) SA12V170E-2	
Coolant Filter.....	WC-56010
Fuel Filter.....	FC-5703
Fuel/Water Separator.....	SFC-5707
Hydraulic Oil Filter.....	H-85680
Hydraulic Oil Filter.....	H-5611
Hydraulic Oil Filter.....	H-7911
Oil Filter By Pass.....	C-5718
<b>D57S-1</b> (DOZERS) S4D130/6501 - 19999	
Air Filter Primary.....	A-5605
Air Filter Secondary.....	A-5606
Air Filter Set.....	A-5604-S
Fuel Filter.....	F-2626
Fuel Filter.....	FC-5602
Hydraulic Oil Filter.....	H-5610
Hydraulic Oil Filter.....	H-56600
Hydraulic Oil Filter.....	H-5620
Oil Filter Full Flow.....	C-5614
Oil Filter Full Flow.....	O-5601
Oil Filter By Pass.....	O-5704
<b>D57S-1</b> (DOZERS) S4D130/29635	
Air Filter Secondary.....	A-5606
Air Filter Set.....	A-5604-S
Air Filter Primary.....	A-5605
Fuel Filter.....	FC-5602
Hydraulic Oil Filter.....	H-5620
Hydraulic Oil Filter.....	H-5611
Hydraulic Oil Filter.....	H-5610
Oil Filter By Pass.....	O-5704
Oil Filter Full Flow.....	C-5614
<b>D57S-1</b> (DOZERS) S6D108/20001	
Air Filter Secondary.....	A-5606
Air Filter Set.....	A-5604-S
Air Filter Primary.....	A-5605
Hydraulic Oil Filter.....	H-5611
Hydraulic Oil Filter.....	H-5610
Hydraulic Oil Filter.....	H-56600
Hydraulic Oil Filter.....	H-5620
Oil Filter Full Flow.....	C-5608
<b>D57S-1B</b> (DOZERS) S6D108	
Air Filter Set.....	A-5604-S
Air Filter Secondary.....	A-5606
Air Filter Primary.....	A-5605
Hydraulic Oil Filter.....	H-5620
Hydraulic Oil Filter.....	H-5610
Hydraulic Oil Filter.....	H-56600
Hydraulic Oil Filter.....	H-5611
Oil Filter Full Flow.....	C-5608
<b>D575A</b> (DOZERS) KOMATSU SA12V170E-2 , 1991	
Fuel/Water Separator.....	SFC-5601-02
Oil Filter By Pass.....	C-5718

MODEL/APPLICATION	SAKURA NO
<b>KOMATSU</b>	
<b>D58-1</b> (DOZERS) 6D125E	
Fuel Filter.....	FC-5606
<b>D58-1</b> (DOZERS) 80588	
Air Filter Primary.....	A-5602
Air Filter Secondary.....	A-5603
Fuel Filter.....	FC-5602
Hydraulic Oil Filter.....	H-5620
Hydraulic Oil Filter.....	H-5608
Hydraulic Oil Filter.....	H-5611
Oil Filter Full Flow.....	C-5614
<b>D58-E</b> (DOZERS)	
Air Filter Primary.....	A-5602
Air Filter Set.....	A-5601-S
Fuel Filter.....	FC-5602
Hydraulic Oil Filter.....	H-5608
Hydraulic Oil Filter.....	H-5611
Hydraulic Oil Filter.....	H-5620
Oil Filter Full Flow.....	C-5614
<b>D58E-1</b> (DOZERS) 6D125/80588	
Air Filter Secondary.....	A-5603
Air Filter Primary.....	A-5602
Fuel Filter.....	FC-5602
Hydraulic Oil Filter.....	H-5608
Hydraulic Oil Filter.....	H-5620
Hydraulic Oil Filter.....	H-5611
Oil Filter Full Flow.....	C-5614
<b>D58E-1</b> (DOZERS) 6D125E	
Fuel Filter.....	FC-5606
<b>D58P-1</b> (DOZERS) 6D125/80588	
Air Filter Primary.....	A-5602
Air Filter Secondary.....	A-5603
Fuel Filter.....	FC-5602
Hydraulic Oil Filter.....	H-5608
Hydraulic Oil Filter.....	H-5620
Hydraulic Oil Filter.....	H-5611
Hydraulic Oil Filter.....	H-5620
Oil Filter Full Flow.....	C-5614
<b>D58P-1</b> (DOZERS) 6D125E	
Fuel Filter.....	FC-5606
<b>D60</b> (DOZERS) 6D125/45001	
Air Filter Set.....	A-5604-S
Air Filter Secondary.....	A-5606
Air Filter Primary.....	A-5605
Fuel Filter.....	FC-5602
Hydraulic Oil Filter.....	H-56600
Hydraulic Oil Filter.....	H-5620
Hydraulic Oil Filter.....	H-5610
Oil Filter Full Flow.....	C-5614
<b>D60</b> (DOZERS) NH220	

MODEL/APPLICATION	SAKURA NO
<b>KOMATSU</b>	
Air Filter Set.....	A-5604-S
Air Filter Secondary.....	A-5606
Air Filter Primary.....	A-5605
Fuel Filter.....	F-5601
Hydraulic Oil Filter.....	H-5620
Hydraulic Oil Filter.....	H-5610
Hydraulic Oil Filter.....	H-56600
Oil Filter Full Flow.....	O-5603
Oil Filter By Pass.....	O-5704
<b>D60A</b> (DOZERS)	
Air Filter Set.....	A-5604-S
Air Filter Secondary.....	A-5606
Air Filter Primary.....	A-5605
Fuel Filter.....	FC-5602
Hydraulic Oil Filter.....	H-5601
Hydraulic Oil Filter.....	H-5620
Oil Filter Full Flow.....	C-5614
<b>D60A-6</b> (DOZERS) NH220-C1	
Air Filter Set.....	A-5604-S
Air Filter Secondary.....	A-5606
Air Filter Primary.....	A-5605
Coolant Filter.....	WC-5707
Fuel Filter.....	F-5601
Hydraulic Oil Filter.....	H-5601
Hydraulic Oil Filter.....	H-5620
Oil Filter By Pass.....	O-5704
Oil Filter Full Flow.....	O-5603
<b>D60A-7</b> (DOZERS) NH220C1	
Air Filter Set.....	A-5604-S
Air Filter Secondary.....	A-5606
Air Filter Primary.....	A-5605
Fuel Filter.....	FC-5602
Fuel Filter.....	FC-5606
Hydraulic Oil Filter.....	H-5601
Hydraulic Oil Filter.....	H-5620
Oil Filter Full Flow.....	C-5701
Oil Filter Full Flow.....	C-5715
Oil Filter By Pass.....	O-5704
Oil Filter Full Flow.....	C-5605
<b>D60A-8</b> (DOZERS) 6D125	
Air Filter Secondary.....	A-5606
Air Filter Primary.....	A-5605
Air Filter Set.....	A-5604-S
Fuel Filter.....	FC-5602
Fuel Filter.....	FC-5606
Hydraulic Oil Filter.....	H-5620
Hydraulic Oil Filter.....	H-5601
Oil Filter Full Flow.....	C-5614
<b>D60E-6</b> (DOZERS) NH220-C1	
Air Filter Primary.....	A-5605
Air Filter Set.....	A-5604-S
Air Filter Secondary.....	A-5606
Coolant Filter.....	WC-5707
Fuel Filter.....	F-5601

MODEL/APPLICATION	SAKURA NO	MODEL/APPLICATION	SAKURA NO	MODEL/APPLICATION	SAKURA NO
<b>KOMATSU</b>		<b>KOMATSU</b>		<b>KOMATSU</b>	
<b>D60E-6</b> (DOZERS) NH220-C1		Fuel Filter.....	FC-5602	<b>D60P-8</b> (DOZERS) 6D125	
Hydraulic Oil Filter.....	H-5620	Hydraulic Oil Filter.....	H-5607	Air Filter Secondary.....	A-5606
Hydraulic Oil Filter.....	H-5601	Hydraulic Oil Filter.....	H-5620	Air Filter Set.....	A-5604-S
Oil Filter Full Flow.....	O-5603	Oil Filter By Pass.....	O-5704	Air Filter Primary.....	A-5605
Oil Filter By Pass.....	O-5704			Fuel Filter.....	FC-5602
				Fuel Filter.....	FC-5606
<b>D60E-7</b> (DOZERS) NH220C1		<b>D60F-8</b> (DOZERS) 6D125		Hydraulic Oil Filter.....	H-5601
Air Filter Set.....	A-5604-S	Air Filter Secondary.....	A-5606	Hydraulic Oil Filter.....	H-5620
Air Filter Secondary.....	A-5606	Air Filter Set.....	A-5604-S	Oil Filter Full Flow.....	C-5614
Air Filter Primary.....	A-5605	Air Filter Primary.....	A-5605		
Fuel Filter.....	FC-5602	Fuel Filter.....	FC-5602		
Fuel Filter.....	FC-5606	Fuel Filter.....	FC-5606		
Hydraulic Oil Filter.....	H-5620	Hydraulic Oil Filter.....	H-5601		
Hydraulic Oil Filter.....	H-5601	Hydraulic Oil Filter.....	H-5620		
Oil Filter Full Flow.....	C-5701	Oil Filter Full Flow.....	C-5614		
Oil Filter Full Flow.....	C-5605				
Oil Filter By Pass.....	O-5704	<b>D60P</b> (DOZERS) NH220		<b>D60PL-6</b> (DOZERS) NH220-C1	
Oil Filter Full Flow.....	C-5715	Air Filter Set.....	A-5604-S	Air Filter Primary.....	A-5605
		Air Filter Secondary.....	A-5606	Air Filter Set.....	A-5604-S
<b>D60E-8</b> (DOZERS) 6D125		Air Filter Primary.....	A-5605	Air Filter Secondary.....	A-5606
Air Filter Primary.....	A-5605	Fuel Filter.....	F-5601	Coolant Filter.....	WC-5707
Air Filter Set.....	A-5604-S	Hydraulic Oil Filter.....	H-5620	Fuel Filter.....	F-5601
Air Filter Secondary.....	A-5606	Hydraulic Oil Filter.....	H-56600	Hydraulic Oil Filter.....	H-5620
Fuel Filter.....	FC-5606	Hydraulic Oil Filter.....	H-5610	Hydraulic Oil Filter.....	H-5601
Fuel Filter.....	FC-5602	Oil Filter By Pass.....	O-5704	Oil Filter Full Flow.....	O-5603
Hydraulic Oil Filter.....	H-5601	Oil Filter Full Flow.....	O-5603	Oil Filter By Pass.....	O-5704
Hydraulic Oil Filter.....	H-5641				
Hydraulic Oil Filter.....	H-5620	<b>D60P-3</b> (DOZERS) NH220		<b>D60PL-7</b> (DOZERS) NH220C1	
Oil Filter Full Flow.....	C-5614	Air Filter Primary.....	A-5637	Air Filter Set.....	A-5604-S
		Air Filter Primary.....	A-5636	Air Filter Secondary.....	A-5606
<b>D60F-7</b> (DOZERS) NTC-743/40001		Fuel Filter.....	F-5601	Air Filter Primary.....	A-5605
Air Filter Primary.....	A-6113	Hydraulic Oil Filter.....	H-5610	Fuel Filter.....	FC-5606
Air Filter Secondary.....	A-5408	Hydraulic Oil Filter.....	H-56600	Fuel Filter.....	FC-5602
Fuel Filter.....	FC-5602	Oil Filter Full Flow.....	O-5603	Hydraulic Oil Filter.....	H-5620
Hydraulic Oil Filter.....	H-5607	Oil Filter By Pass.....	O-5704	Hydraulic Oil Filter.....	H-5601
Hydraulic Oil Filter.....	H-5620			Oil Filter By Pass.....	O-5704
Oil Filter By Pass.....	O-5704			Oil Filter Full Flow.....	C-5605
				Oil Filter Full Flow.....	C-5715
<b>D60F-7</b> (DOZERS) NTO-6-CI/40001		<b>D60P-6</b> (DOZERS) NH220-C1		Oil Filter Full Flow.....	C-5701
Air Filter Primary.....	A-6113	Air Filter Set.....	A-5604-S	Oil Filter Full Flow.....	C-5701
Air Filter Secondary.....	A-5408	Air Filter Secondary.....	A-5606	Oil Filter By Pass.....	O-5704
Fuel Filter.....	FC-5602	Air Filter Primary.....	A-5605	Oil Filter Full Flow.....	C-5715
Hydraulic Oil Filter.....	H-5607	Coolant Filter.....	WC-5707	Oil Filter Full Flow.....	C-5605
Hydraulic Oil Filter.....	H-5620	Fuel Filter.....	F-5601		
Oil Filter By Pass.....	O-5704	Fuel Filter.....	FC-5606		
		Hydraulic Oil Filter.....	H-5620		
<b>D60F-7A</b> (DOZERS) NTC-743/40001		Hydraulic Oil Filter.....	H-5601	<b>D60PL-6</b> (DOZERS) 6D125	
Air Filter Secondary.....	A-5408	Oil Filter Full Flow.....	O-5603	Air Filter Set.....	A-5604-S
Air Filter Primary.....	A-6113	Oil Filter By Pass.....	O-5704	Air Filter Secondary.....	A-5606
Fuel Filter.....	FC-5602			Air Filter Primary.....	A-5605
Hydraulic Oil Filter.....	H-5620			Fuel Filter.....	FC-5606
Hydraulic Oil Filter.....	H-5607			Fuel Filter.....	FC-5602
Oil Filter By Pass.....	O-5704			Hydraulic Oil Filter.....	H-5601
				Hydraulic Oil Filter.....	H-5620
<b>D60F-7A</b> (DOZERS) NTO-6-CI/40001		<b>D60P-7</b> (DOZERS) NH220C1		Oil Filter Full Flow.....	C-5614
Air Filter Secondary.....	A-5408	Air Filter Set.....	A-5604-S		
Air Filter Primary.....	A-6113	Air Filter Secondary.....	A-5606		
Fuel Filter.....	FC-5602	Air Filter Primary.....	A-5605		
Hydraulic Oil Filter.....	H-5620	Fuel Filter.....	FC-5606		
Hydraulic Oil Filter.....	H-5607	Fuel Filter.....	FC-5602		
Oil Filter By Pass.....	O-5704	Hydraulic Oil Filter.....	H-5601		
		Hydraulic Oil Filter.....	H-5620		
		Oil Filter Full Flow.....	C-5701		
		Oil Filter By Pass.....	O-5704		
		Oil Filter Full Flow.....	C-5715		
		Oil Filter Full Flow.....	C-5605		
				<b>D60S-3</b> (DOZERS) NH220	
				Air Filter Primary.....	A-5637
				Air Filter Primary.....	A-5636
				Fuel Filter.....	F-5601
				Hydraulic Oil Filter.....	H-5610
				Hydraulic Oil Filter.....	H-56600
				Oil Filter Full Flow.....	O-5603
				Oil Filter By Pass.....	O-5704
				<b>D60S-6</b> (DOZERS) NH220	
				Air Filter Secondary.....	A-5606
				Air Filter Set.....	A-5604-S
				Air Filter Primary.....	A-5605

# Sakura Filter

# ENGINE APPLICATION

MODEL/APPLICATION	SAKURA NO	MODEL/APPLICATION	SAKURA NO	MODEL/APPLICATION	SAKURA NO
<b>KOMATSU</b>		<b>KOMATSU</b>		<b>KOMATSU</b>	
<b>D60S-6</b> (DOZERS) NH220		Air Filter Secondary.....	A-5667	<b>D61PXI-23</b> (DOZERS) SAA6D107E-2 , 2013	
Fuel Filter.....	F-5601	Air Filter Primary.....	A-5666	Air Filter Secondary.....	A-5667
Hydraulic Oil Filter.....	H-5620	Cabin Air Filter Set.....	CA-5603-S	Air Filter Primary.....	A-5666
Hydraulic Oil Filter.....	H-5610	Cabin Air Filter.....	CA-56041		
Hydraulic Oil Filter.....	H-56600	Coolant Filter.....	WC-5706	<b>D61PXI-23</b> (DOZERS) SAA6D107E-2	
Oil Filter Full Flow.....	O-5603	Hydraulic Oil Filter.....	H-5607	Hydraulic Oil Filter.....	H-56540
Oil Filter By Pass.....	O-5704	Hydraulic Oil Filter Return.....	HC-5603		
		Oil Filter Combination.....	C-5723	<b>D61EX-15E0-BW</b> (DOZERS) SAA6D107E-1KB-W	
<b>D60S-7</b> (DOZERS) NH220C1		<b>D61EXI-23</b> (DOZERS) SAA6D107E-2 , 2013		Hydraulic Oil Filter.....	H-56540
Air Filter Primary.....	A-5605	Air Filter Secondary.....	A-5667		
Air Filter Set.....	A-5604-S	Air Filter Primary.....	A-5666	<b>D61PX-15E0-BW</b> (DOZERS)	
Air Filter Secondary.....	A-5606			Hydraulic Oil Filter.....	H-56540
Fuel Filter.....	FC-5606	<b>D61EXI-23</b> (DOZERS) SAA6D107E-2			
Fuel Filter.....	FC-5602	Hydraulic Oil Filter.....	H-56540	<b>D63E</b> (DOZERS) 6D125E/1292	
Hydraulic Oil Filter.....	H-56600			Air Filter Primary.....	A-5602
Hydraulic Oil Filter.....	H-5610	<b>D61EX-15</b> (DOZERS) SAA6D107E-1 , 2005		Air Filter Secondary.....	A-5603
Hydraulic Oil Filter.....	H-5620	Air Filter Secondary.....	A-5667	Fuel Filter.....	FC-5602
Oil Filter By Pass.....	O-5704	Air Filter Primary.....	A-5666	Hydraulic Oil Filter.....	H-5608
Oil Filter Full Flow.....	C-5605	Cabin Air Filter.....	CA-5602	Hydraulic Oil Filter.....	H-5611
Oil Filter Full Flow.....	C-5715	Cabin Air Filter.....	CA-56041	Hydraulic Oil Filter.....	H-5620
Oil Filter Full Flow.....	C-5701	Coolant Filter.....	WC-5706	Oil Filter Full Flow.....	C-5614
		Fuel Filter.....	F-5218	<b>D63E-1</b> (DOZERS) 6D125	
<b>D60S-8</b> (DOZERS) 6D125		Hydraulic Oil Filter.....	H-5607	Fuel Filter.....	FC-5606
Fuel Filter.....	FC-5606	Oil Filter Combination.....	C-5723	<b>D63E-1</b> (DOZERS) 6D125/1001	
		<b>D61EX-15</b> (DOZERS) SAA6D107E-1 (S/N: B40001-49999)		Air Filter Secondary.....	A-5603
<b>D60S-8</b> (DOZERS) S/N: 45001		Hydraulic Oil Filter.....	H-56540	Air Filter Primary.....	A-5602
Air Filter Set.....	A-5604-S	<b>D61EX-23</b> (DOZERS) SAA6D107E-2 , 2013		Fuel Filter.....	FC-5602
Air Filter Secondary.....	A-5606	Air Filter Secondary.....	A-5667	Hydraulic Oil Filter.....	H-5608
Air Filter Primary.....	A-5605	Air Filter Primary.....	A-5666	Hydraulic Oil Filter.....	H-5611
Fuel Filter.....	FC-5602			Hydraulic Oil Filter.....	H-5620
Hydraulic Oil Filter.....	H-5610	<b>D61EX-23</b> (DOZERS) SAA6D107E-2		Oil Filter Full Flow.....	C-5614
Hydraulic Oil Filter.....	H-5620	Hydraulic Oil Filter.....	H-56540	<b>D65</b> (DOZERS) 2007	
Oil Filter Full Flow.....	C-5614			Fuel Filter.....	FC-5621
		<b>D61EX-12</b> (DOZERS) S6D114E-1		<b>D65A</b> (DOZERS)	
Air Filter Secondary.....	A-5667	Air Filter Secondary.....	A-5667	Air Filter Primary.....	A-5605
Air Filter Primary.....	A-5666	<b>D61PX-15</b> (DOZERS) SAA6D107E-1 , 2005		Air Filter Set.....	A-5604-S
Cabin Air Filter.....	CA-56041	Air Filter Secondary.....	A-5667	Air Filter Secondary.....	A-5606
Cabin Air Filter Set.....	CA-5603-S	Air Filter Primary.....	A-5666	Fuel Filter.....	FC-5602
Coolant Filter.....	WC-5706	Cabin Air Filter.....	CA-56041	Hydraulic Oil Filter.....	H-5620
Hydraulic Oil Filter Return.....	HC-5603	Cabin Air Filter.....	CA-5602	Hydraulic Oil Filter.....	H-5601
Hydraulic Oil Filter.....	H-5607	Coolant Filter.....	WC-5706	Oil Filter Full Flow.....	C-5614
Oil Filter Combination.....	C-5723	Fuel Filter Secondary.....	FC-7903	<b>D65A</b> (DOZERS) NH220	
		Fuel/Water Separator.....	SFC-5708	Air Filter Primary.....	A-5605
<b>D61EX-15E0</b> (DOZERS) SAA6D107E-1		Hydraulic Oil Filter.....	H-5607	Air Filter Set.....	A-5604-S
Air Filter Secondary.....	A-5667	Oil Filter Combination.....	C-5723	Air Filter Secondary.....	A-5606
Air Filter Primary.....	A-5666			Fuel Filter.....	F-5601
Cabin Air Filter.....	CA-5602	<b>D61PX-15</b> (DOZERS) SAA6D107E-1 (S/N: B40001-49999)		Hydraulic Oil Filter.....	H-5620
Cabin Air Filter.....	CA-56041	Hydraulic Oil Filter.....	H-56540	Hydraulic Oil Filter.....	H-5601
Hydraulic Oil Filter.....	H-5607	<b>D61PX-23</b> (DOZERS) SAA6D107E-2 , 2013		Oil Filter Full Flow.....	C-5614
Oil Filter Full Flow.....	C-5611	Air Filter Secondary.....	A-5667	<b>D65A</b> (DOZERS) NH220	
		Air Filter Primary.....	A-5666	Air Filter Primary.....	A-5605
<b>D61EX-15E0</b> (DOZERS) SAA6D107E-1 (S/N: B45001-UP)		<b>D61PX-23</b> (DOZERS) SAA6D107E-2		Air Filter Set.....	A-5604-S
Fuel Filter.....	FC-5613	Hydraulic Oil Filter.....	H-56540	Air Filter Secondary.....	A-5606
Hydraulic Oil Filter.....	H-56540			Fuel Filter.....	F-5601
		<b>D61PX-12</b> (DOZERS) S6D114E-1		Hydraulic Oil Filter.....	H-5620
<b>D61PX-12</b> (DOZERS) S6D114E-1		Hydraulic Oil Filter.....	H-56540	Hydraulic Oil Filter.....	H-5610
				Hydraulic Oil Filter.....	H-56600
				Oil Filter Full Flow.....	O-5603
				Oil Filter By Pass.....	O-5704

MODEL/APPLICATION	SAKURA NO	MODEL/APPLICATION	SAKURA NO	MODEL/APPLICATION	SAKURA NO
<b>KOMATSU</b>		<b>KOMATSU</b>		<b>KOMATSU</b>	
<b>D65A-6</b> (DOZERS) NH220		Air Filter Secondary.....	A-5408	<b>D65E-7</b> (DOZERS) NH220C1	
Air Filter Primary.....	A-5605	Air Filter Primary.....	A-6113	Fuel Filter.....	FC-5606
Air Filter Set.....	A-5604-S	Fuel Filter.....	FC-5602	<b>D65E-7</b> (DOZERS) NH220-C1/40001	
Air Filter Secondary.....	A-5606	Hydraulic Oil Filter.....	H-5607	Air Filter Primary.....	A-5605
Fuel Filter.....	F-5601	Hydraulic Oil Filter.....	H-5610	Air Filter Set.....	A-5604-S
Hydraulic Oil Filter.....	H-5610	Hydraulic Oil Filter.....	H-56600	Air Filter Secondary.....	A-5606
Hydraulic Oil Filter.....	H-5620	Oil Filter Full Flow.....	C-5715	Fuel Filter.....	FC-5602
Hydraulic Oil Filter.....	H-56600	Oil Filter Full Flow.....	C-5605	Hydraulic Oil Filter.....	H-5601
Oil Filter Full Flow.....	O-5603	Oil Filter Full Flow.....	C-5701	Hydraulic Oil Filter.....	H-5620
Oil Filter By Pass.....	O-5704			Oil Filter By Pass.....	O-5704
<b>D65A-6</b> (DOZERS) NH220-C1		<b>D65E-12</b> (DOZERS) 6D125/60001 - 60941		Oil Filter Full Flow.....	C-5605
Air Filter Set.....	A-5604-S	Air Filter Secondary.....	A-5408	Oil Filter Full Flow.....	C-5701
Air Filter Secondary.....	A-5606	Air Filter Primary.....	A-6113	Oil Filter Full Flow.....	C-5701
Air Filter Primary.....	A-5605	Air Filter Secondary.....	A-5603	Oil Filter Full Flow.....	C-5715
Coolant Filter.....	WC-5707	Air Filter Primary.....	A-5602		
Fuel Filter.....	F-5601	Fuel Filter.....	FC-5602	<b>D65E-8</b> (DOZERS) 6D125	
Hydraulic Oil Filter.....	H-5620	Hydraulic Oil Filter.....	H-5610	Fuel Filter.....	FC-5606
Hydraulic Oil Filter.....	H-5601	Hydraulic Oil Filter.....	H-56600	<b>D65E-8</b> (DOZERS) 6D125/45001	
Oil Filter By Pass.....	O-5704	Hydraulic Oil Filter.....	H-5607	Air Filter Set.....	A-5604-S
Oil Filter Full Flow.....	O-5603	Oil Filter Full Flow.....	C-5715	Air Filter Secondary.....	A-5606
		Oil Filter Full Flow.....	C-5701	Air Filter Primary.....	A-5605
		Oil Filter Full Flow.....	C-5614	Fuel Filter.....	FC-5602
		Oil Filter Full Flow.....	C-5605	Hydraulic Oil Filter.....	H-5601
				Hydraulic Oil Filter.....	H-5620
				Oil Filter Full Flow.....	C-5614
<b>D65A-7</b> (DOZERS) NH220C1		<b>D65E-12</b> (DOZERS) S6D125			
Fuel Filter.....	FC-5606	Air Filter Secondary.....	A-5408	<b>D65EX-12</b> (DOZERS) 6D125/60001 - 60941	
<b>D65A-7</b> (DOZERS) NH220-C1/40001		Air Filter Primary.....	A-6113	Air Filter Primary.....	A-6113
Air Filter Primary.....	A-5605	Fuel Filter.....	FC-5602	Air Filter Secondary.....	A-5408
Air Filter Secondary.....	A-5606	Hydraulic Oil Filter.....	H-5607	Fuel Filter.....	FC-5602
Air Filter Set.....	A-5604-S	Hydraulic Oil Filter.....	H-5610	Hydraulic Oil Filter.....	H-5607
Fuel Filter.....	FC-5602	Hydraulic Oil Filter.....	H-56600	Hydraulic Oil Filter.....	H-56600
Hydraulic Oil Filter.....	H-5601	Oil Filter Full Flow.....	C-5715	Hydraulic Oil Filter.....	H-5610
Hydraulic Oil Filter.....	H-5620	Oil Filter Full Flow.....	C-5701	Oil Filter Full Flow.....	C-5605
Oil Filter Full Flow.....	C-5715	Oil Filter Full Flow.....	C-5605	Oil Filter Full Flow.....	C-5701
Oil Filter By Pass.....	O-5704			Oil Filter Full Flow.....	C-5715
Oil Filter Full Flow.....	C-5701	<b>D65E-12</b> (DOZERS) S6D125/60001 - 60941		<b>D65EX-12</b> (DOZERS) S6D125/60001 - 60941	
Oil Filter Full Flow.....	C-5605	Air Filter Primary.....	A-6113	Air Filter Secondary.....	A-5408
		Air Filter Secondary.....	A-5603	Air Filter Primary.....	A-6113
		Air Filter Primary.....	A-5602	Fuel Filter.....	FC-5602
		Air Filter Secondary.....	A-5408	Hydraulic Oil Filter.....	H-5607
		Fuel Filter.....	FC-5602	Hydraulic Oil Filter.....	H-56600
		Hydraulic Oil Filter.....	H-5607	Hydraulic Oil Filter.....	H-5610
		Hydraulic Oil Filter.....	H-5610	Oil Filter Full Flow.....	C-5605
		Hydraulic Oil Filter.....	H-56600	Oil Filter Full Flow.....	C-5701
		Oil Filter Full Flow.....	C-5605	Oil Filter Full Flow.....	C-5715
		Oil Filter Full Flow.....	C-5701	<b>D65EX-12</b> (DOZERS) S6D125E-2	
		Oil Filter Full Flow.....	C-5614	Fuel Filter.....	F-56040
		Oil Filter Full Flow.....	C-5715	<b>D65EX-15</b> (DOZERS) SA6D125E-3/67001/69000	
				Air Filter Primary.....	A-5558M
				Air Filter Secondary.....	A-5559
				Air Filter Set.....	A-5558M-S
<b>D65A-8</b> (DOZERS) 6D125		<b>D65E-6</b> (DOZERS) NH220-C1			
Fuel Filter.....	FC-5606	Air Filter Primary.....	A-5605		
<b>D65A-8</b> (DOZERS) 6D125/45001		Air Filter Secondary.....	A-5606		
Air Filter Set.....	A-5604-S	Air Filter Set.....	A-5604-S		
Air Filter Primary.....	A-5605	Coolant Filter.....	WC-5707		
Air Filter Secondary.....	A-5606	Fuel Filter.....	F-5601		
Fuel Filter.....	FC-5602	Oil Filter Full Flow.....	O-5603		
Hydraulic Oil Filter.....	H-5601	Oil Filter By Pass.....	O-5704		
Hydraulic Oil Filter.....	H-5620				
Oil Filter Full Flow.....	C-5614				
<b>D65C-6</b> (DOZERS) NH220		<b>D65E-12</b> (DOZERS) 6D125			
Coolant Filter.....	WC-5711	Air Filter Primary.....	A-5605		
Fuel Filter.....	F-5601	Air Filter Secondary.....	A-5606		
Oil Filter Full Flow.....	O-5603				
Oil Filter By Pass.....	O-5704				

# Sakura Filter

# ENGINE APPLICATION

MODEL/APPLICATION	SAKURA NO	MODEL/APPLICATION	SAKURA NO	MODEL/APPLICATION	SAKURA NO
<b>KOMATSU</b>		<b>KOMATSU</b>		<b>KOMATSU</b>	
<b>D65EX-15</b> (DOZERS) SAA6D114E-3 (S/N: 67001/69000) Hydraulic Oil Filter.....	H-5607	Oil Filter Full Flow.....	C-5605	Air Filter Secondary.....	A-5606
<b>D65EX-15E0</b> (DOZERS) SAA6D114E-3 (S/N: 69001-UP) , 2007 Air Filter Primary.....	A-5558M	<b>D65P-6</b> (DOZERS) NH220 Air Filter Secondary.....	A-5606	Fuel Filter.....	F-5601
Air Filter Secondary.....	A-5559	Air Filter Set.....	A-5604-S	Hydraulic Oil Filter.....	H-5610
Air Filter Set.....	A-5558M-S	Air Filter Primary.....	A-5605	Hydraulic Oil Filter.....	H-5620
Cabin Air Filter.....	CA-56041	Fuel Filter.....	F-5601	Hydraulic Oil Filter.....	H-56600
Cabin Air Filter.....	CA-5602	Hydraulic Oil Filter.....	H-56600	Oil Filter By Pass.....	O-5704
Hydraulic Breather.....	H-56610	Hydraulic Oil Filter.....	H-5620	Oil Filter Full Flow.....	O-5603
<b>D65EX-15E0</b> (DOZERS) SAA6D114E-3 (S/N: 69001-UP) Fuel Filter.....	FC-5613	Hydraulic Oil Filter.....	H-5610		
<b>D65F-8</b> (DOZERS) 6D125 Fuel Filter.....	FC-5606	Oil Filter Full Flow.....	O-5603	<b>D65PL-6</b> (DOZERS) NH220-C1 Air Filter Primary.....	A-5605
<b>D65F-8</b> (DOZERS) 6D125/45001 Air Filter Set.....	A-5604-S	Oil Filter By Pass.....	O-5704	Air Filter Set.....	A-5604-S
Air Filter Secondary.....	A-5606			Air Filter Secondary.....	A-5606
Air Filter Primary.....	A-5605	<b>D65P-6</b> (DOZERS) NH220-C1 Air Filter Secondary.....	A-5606	Coolant Filter.....	WC-5707
Fuel Filter.....	FC-5602	Air Filter Set.....	A-5604-S	Fuel Filter.....	F-5601
Hydraulic Oil Filter.....	H-5620	Air Filter Primary.....	A-5605	Hydraulic Oil Filter.....	H-5620
Hydraulic Oil Filter.....	H-5601	Coolant Filter.....	WC-5707	Hydraulic Oil Filter.....	H-5601
Oil Filter Full Flow.....	C-5614	Fuel Filter.....	F-5601	Oil Filter Full Flow.....	O-5603
<b>D65P</b> (DOZERS) NH220 Air Filter Set.....	A-5604-S	Hydraulic Oil Filter.....	H-5620	Oil Filter By Pass.....	O-5704
Air Filter Secondary.....	A-5606	Hydraulic Oil Filter.....	H-5601		
Air Filter Primary.....	A-5605	Oil Filter Full Flow.....	O-5603	<b>D65PL-7</b> (DOZERS) NH220C1 Fuel Filter.....	FC-5606
Fuel Filter.....	F-5601	Oil Filter By Pass.....	O-5704		
Hydraulic Oil Filter.....	H-5620			<b>D65PL-7</b> (DOZERS) NH220-C1/40001 Air Filter Set.....	A-5604-S
Hydraulic Oil Filter.....	H-5610	<b>D65P-7</b> (DOZERS) NH220C1 Fuel Filter.....	FC-5606	Air Filter Secondary.....	A-5606
Hydraulic Oil Filter.....	H-56600			Air Filter Primary.....	A-5605
Oil Filter Full Flow.....	O-5603	<b>D65P-7</b> (DOZERS) NH220-C1/40001 Air Filter Set.....	A-5604-S	Fuel Filter.....	FC-5602
Oil Filter By Pass.....	O-5704	Air Filter Primary.....	A-5605	Hydraulic Oil Filter.....	H-5620
		Air Filter Secondary.....	A-5606	Hydraulic Oil Filter.....	H-5601
<b>D65P-12</b> (DOZERS) 6D125/60001 - 60941 Air Filter Secondary.....	A-5408	Fuel Filter.....	FC-5602	Oil Filter By Pass.....	O-5704
Air Filter Primary.....	A-6113	Hydraulic Oil Filter.....	H-5601	Oil Filter Full Flow.....	C-5605
Fuel Filter.....	FC-5602	Hydraulic Oil Filter.....	H-5620	Oil Filter Full Flow.....	C-5701
Hydraulic Oil Filter.....	H-5610	Oil Filter Full Flow.....	C-5605	Oil Filter Full Flow.....	C-5715
Hydraulic Oil Filter.....	H-56600	Oil Filter By Pass.....	O-5704	Oil Filter Full Flow.....	C-5715
Hydraulic Oil Filter.....	H-5607	Oil Filter Full Flow.....	C-5715		
Oil Filter Full Flow.....	C-5605	<b>D65P-8</b> (DOZERS) 6D105-1 Oil Filter Full Flow.....	C-5614	<b>D65PL-6</b> (DOZERS) NH220 Air Filter Primary.....	A-5605
Oil Filter Full Flow.....	C-5701	<b>D65P-8</b> (DOZERS) 6D125 Fuel Filter.....	FC-5606	Air Filter Set.....	A-5604-S
Oil Filter Full Flow.....	C-5715	<b>D65P-8</b> (DOZERS) 6D125/45001 Air Filter Set.....	A-5604-S	Air Filter Secondary.....	A-5606
		Air Filter Secondary.....	A-5606	Air Filter Primary.....	A-5605
<b>D65P-12</b> (DOZERS) S6D125/60001 - 60941 Air Filter Secondary.....	A-5408	Fuel Filter.....	FC-5602	Fuel Filter.....	FC-5602
Air Filter Primary.....	A-6113	Hydraulic Oil Filter.....	H-5601	Hydraulic Oil Filter.....	H-5601
Fuel Filter.....	FC-5602	Hydraulic Oil Filter.....	H-5620	Hydraulic Oil Filter.....	H-5620
Hydraulic Oil Filter.....	H-56600	Oil Filter Full Flow.....	C-5614	Oil Filter Full Flow.....	C-5614
Hydraulic Oil Filter.....	H-5607	<b>D65PL-6</b> (DOZERS) NH220 Air Filter Primary.....	A-5605	<b>D65PX-12</b> (DOZERS) 6D125/60001 - 60941 Air Filter Primary.....	A-6113
Hydraulic Oil Filter.....	H-5610	Air Filter Set.....	A-5604-S	Air Filter Secondary.....	A-5408
Oil Filter Full Flow.....	C-5701			Fuel Filter.....	FC-5602
Oil Filter Full Flow.....	C-5715			Hydraulic Oil Filter.....	H-5607
				Hydraulic Oil Filter.....	H-5610
				Hydraulic Oil Filter.....	H-56600
				Oil Filter Full Flow.....	C-5605
				Oil Filter Full Flow.....	C-5715
				Oil Filter Full Flow.....	C-5701
				<b>D65PX-12</b> (DOZERS) S6D125/60001 - 60941	



# Sakura Filter

# ENGINE APPLICATION

MODEL/APPLICATION	SAKURA NO	MODEL/APPLICATION	SAKURA NO	MODEL/APPLICATION	SAKURA NO
<b>KOMATSU</b>		<b>KOMATSU</b>		<b>KOMATSU</b>	
<b>D65PX-12</b> (DOZERS) S6D125/60001 - 60941		<b>D65S-8</b> (DOZERS) 6D125/45001		Cabin Air Filter.....	CA-5602
Air Filter Primary.....	A-6113	Air Filter Set.....	A-5604-S	Hydraulic Oil Filter.....	H-56650
Air Filter Secondary.....	A-5408	Air Filter Secondary.....	A-5606	<b>D65WX-16</b> (DOZERS) SAA6D114E-3	
Fuel Filter.....	FC-5602	Air Filter Primary.....	A-5605	Fuel Filter.....	FC-5613
Hydraulic Oil Filter.....	H-5610	Fuel Filter.....	FC-5602	<b>D65EX-18</b> (DOZERS) KOMATSU SAA6D114E-6	
Hydraulic Oil Filter.....	H-56600	Hydraulic Oil Filter.....	H-5620	Hydraulic Oil Filter.....	H-56652
Hydraulic Oil Filter.....	H-5607	Hydraulic Oil Filter.....	H-5610	<b>D66S-1</b> (LOADERS) SAA6D110	
Oil Filter Full Flow.....	C-5701	Hydraulic Oil Filter.....	H-56600	Fuel Filter.....	FC-5606
Oil Filter Full Flow.....	C-5605	Oil Filter Full Flow.....	C-5614	<b>D66S-1</b> (LOADERS) SAA6D110/1001	
Oil Filter Full Flow.....	C-5715	<b>D65WX-15E</b> (DOZERS)		Air Filter Primary.....	A-6113
<b>D65PX-15</b> (DOZERS) SAA6D125E-3/67001/69000		Air Filter Primary.....	A-5558M	Air Filter Secondary.....	A-5408
Air Filter Primary.....	A-5558M	Air Filter Secondary.....	A-5559	Fuel Filter.....	FC-5602
Air Filter Secondary.....	A-5559	Air Filter Set.....	A-5558M-S	Hydraulic Oil Filter.....	H-5611
Air Filter Set.....	A-5558M-S	Air Filter Set.....	A-5558M-S	Hydraulic Oil Filter.....	H-5610
Fuel/Water Separator Secondary..	SFC-5611-10	Cabin Air Filter.....	CA-56041	Hydraulic Oil Filter.....	H-56600
Fuel/Water Separator Secondary..	SFC-5611-10B	Fuel Filter.....	FC-5613	Oil Filter Full Flow.....	C-5614
<b>D65PX-15E0</b> (DOZERS) SAA6D114E-3 (S/N: 69001-UP) , 2007		Hydraulic Oil Filter.....	H-5607	<b>D68-1</b> (DOZERS) S/N: 45590	
Air Filter Primary.....	A-5558M	<b>D65-16</b> (DOZERS) SAA6D114E-3 , 2010		Air Filter Set.....	A-5604-S
Air Filter Secondary.....	A-5559	Air Filter Set.....	A-5558M-S	Air Filter Secondary.....	A-5606
Air Filter Set.....	A-5558M-S	Air Filter Primary.....	A-5558M	Air Filter Primary.....	A-5605
Cabin Air Filter.....	CA-5602	Air Filter Secondary.....	A-5559	Fuel Filter.....	FC-5602
Cabin Air Filter.....	CA-56041	Hydraulic Oil Filter.....	H-56650	Hydraulic Oil Filter.....	H-5601
Hydraulic Breather.....	H-56610	<b>D65EX-16</b> (DOZERS) SAA6D114E-3 , 2010		Hydraulic Oil Filter.....	H-5620
<b>D65PX-15E0</b> (DOZERS) SAA6D114E-3 (S/N: 69001-UP)		Air Filter Secondary.....	A-5559	Oil Filter Full Flow.....	C-5614
Fuel Filter.....	FC-5613	Air Filter Set.....	A-5558M-S	<b>D68E-1</b> (DOZERS) 6D125	
<b>D65S-6</b> (DOZERS) NH220		Air Filter Primary.....	A-5558M	Air Filter Primary.....	A-5623
Air Filter Primary.....	A-5605	Air Filter Secondary.....	A-5559	Air Filter Set.....	A-5622-S
Air Filter Secondary.....	A-5606	Hydraulic Oil Filter.....	H-56650	Air Filter Secondary.....	A-5624
Air Filter Set.....	A-5604-S	<b>D65EX-16</b> (DOZERS) KOMATSU SAA6D114E-3		Fuel Filter.....	FC-5606
Fuel Filter.....	F-5601	Fuel Filter.....	FC-56270	Fuel Filter.....	FC-5602
Hydraulic Oil Filter.....	H-56600	Oil Filter Transmission.....	TC-56010	Hydraulic Oil Filter.....	H-5620
Hydraulic Oil Filter.....	H-5610	<b>D65EX-16</b> (DOZERS) SAA6D114E-3		Hydraulic Oil Filter.....	H-5601
Hydraulic Oil Filter.....	H-5620	Fuel Filter.....	FC-5613	Hydraulic Oil Filter.....	H-5601
Oil Filter Full Flow.....	O-5603	<b>D65PX-16</b> (DOZERS) SAA6D114E-3 , 2010		Oil Filter By Pass.....	C-5718
Oil Filter Full Flow.....	O-5704	Air Filter Secondary.....	A-5559	<b>D70-LE</b> (DOZERS) 6D125	
<b>D65S-7</b> (DOZERS) NH220C1		Air Filter Set.....	A-5558M-S	Fuel Filter.....	FC-5606
Air Filter Set.....	A-5604-S	Air Filter Primary.....	A-5558M	<b>D70-LE</b> (DOZERS) 6D125/45200	
Air Filter Primary.....	A-5605	Cabin Air Filter.....	CA-5602	Air Filter Secondary.....	A-5408
Air Filter Secondary.....	A-5606	Hydraulic Oil Filter.....	H-56650	Air Filter Secondary.....	A-5606
Fuel Filter.....	FC-5606	<b>D65PX-16</b> (DOZERS) KOMATSU SAA6D114E-3		Air Filter Set.....	A-5604-S
Fuel Filter.....	FC-5602	Fuel Filter.....	FC-56270	Air Filter Primary.....	A-5605
Hydraulic Oil Filter.....	H-5610	Oil Filter Transmission.....	TC-56010	Air Filter Primary.....	A-6113
Hydraulic Oil Filter.....	H-56600	<b>D65PX-16</b> (DOZERS) SAA6D114E-3		Fuel Filter.....	FC-5602
Hydraulic Oil Filter.....	H-5620	Fuel Filter.....	FC-5613	Hydraulic Oil Filter.....	H-5601
Oil Filter By Pass.....	O-5704	<b>D65WX-16</b> (DOZERS) SAA6D114E-3 , 2011		Hydraulic Oil Filter.....	H-5620
Oil Filter Full Flow.....	C-5605	Air Filter Primary.....	A-5558M	Oil Filter Full Flow.....	C-5614
Oil Filter Full Flow.....	C-5715	Air Filter Secondary.....	A-5559	<b>D75A-1</b> (DOZERS) S6D125	
Oil Filter Full Flow.....	C-5701	Air Filter Set.....	A-5558M-S	Fuel Filter.....	FC-5606
<b>D65S-8</b> (DOZERS) 6D125		<b>D65PX-16</b> (DOZERS) SAA6D114E-3 , 2011			
Fuel Filter.....	FC-5606	Air Filter Primary.....	A-5558M		
		Air Filter Secondary.....	A-5559		
		Air Filter Set.....	A-5558M-S		

# Sakura Filter

# ENGINE APPLICATION

MODEL/APPLICATION	SAKURA NO	MODEL/APPLICATION	SAKURA NO	MODEL/APPLICATION	SAKURA NO
<b>KOMATSU</b>		<b>KOMATSU</b>		<b>KOMATSU</b>	
<b>D75A-1</b> <b>(DOZERS)</b> <b>S6D125/10001</b> Air Filter Set..... A-5604-S Air Filter Primary..... A-5605 Air Filter Secondary..... A-5606 Fuel Filter..... FC-5602 Hydraulic Oil Filter..... H-5620 Hydraulic Oil Filter..... H-5601 Oil Filter Full Flow..... C-5605 Oil Filter Full Flow..... C-5701 Oil Filter Full Flow..... C-5715		<b>D80-18</b> <b>(DOZERS)</b> <b>NT-855/25001</b> Air Filter Secondary..... A-5610 Air Filter Primary..... A-5614 Fuel Filter..... FC-5602 Fuel Filter..... F-5601 Hydraulic Oil Filter..... H-5606 Hydraulic Oil Filter..... H-5610 Hydraulic Oil Filter..... H-56600 Oil Filter Full Flow..... C-5715 Oil Filter By Pass..... O-5704 Oil Filter Full Flow..... C-5605 Oil Filter Full Flow..... C-5701		<b>D80A-18</b> <b>(DOZERS)</b> <b>CUMMINS NT-855</b> Fuel Filter..... FC-5606  <b>D80A-18</b> <b>(DOZERS)</b> <b>NT-855</b> Air Filter Secondary..... A-5610 Air Filter Primary..... A-5614 Coolant Filter..... WC-5711 Fuel Filter..... FC-5602 Hydraulic Oil Filter..... H-5610 Hydraulic Oil Filter..... H-56600 Hydraulic Oil Filter..... H-5606 Oil Filter Full Flow..... C-5715 Oil Filter Full Flow..... C-5605 Oil Filter Full Flow..... C-5701 Oil Filter By Pass..... O-5704	
<b>D75S-2</b> <b>(LOADERS)</b> <b>NH220</b> Air Filter Primary..... A-5623 Air Filter Secondary..... A-5624 Air Filter Set..... A-5622-S Coolant Filter..... WC-5711 Fuel Filter..... F-5601 Hydraulic Oil Filter..... H-5610 Hydraulic Oil Filter..... H-56600 Oil Filter Full Flow..... O-5603 Oil Filter By Pass..... O-5704		<b>D80-8</b> <b>(DOZERS)</b> <b>CUMMINS</b> Air Filter Primary..... A-5636 Coolant Filter..... WC-5711 Fuel Filter..... F-5601 Hydraulic Oil Filter..... H-5610 Hydraulic Oil Filter..... H-56600 Hydraulic Oil Filter..... H-55270 Hydraulic Oil Filter..... H-5504 Oil Filter Full Flow..... O-5603 Oil Filter By Pass..... O-5704		<b>D80E</b> <b>(DOZERS)</b> <b>NT-855</b> Air Filter Secondary..... A-5610 Air Filter Primary..... A-5614 Coolant Filter..... WC-5707 Fuel Filter..... FC-5720 Fuel Filter..... F-5601 Fuel/Water Separator..... SFC-5705 Hydraulic Oil Filter..... H-5606 Hydraulic Oil Filter..... H-5610 Hydraulic Oil Filter..... H-56600 Oil Filter Full Flow..... C-5715 Oil Filter By Pass..... O-5704 Oil Filter Full Flow..... C-5701 Oil Filter Full Flow..... C-5605	
<b>D75S-3</b> <b>(LOADERS)</b> <b>NTO-6-C1</b> Air Filter Secondary..... A-5408 Air Filter Primary..... A-6113 Fuel Filter..... FC-5606 Fuel Filter..... F-5601 Hydraulic Oil Filter..... H-5610 Hydraulic Oil Filter..... H-5606 Hydraulic Oil Filter..... H-56600 Oil Filter Full Flow..... O-5603 Oil Filter By Pass..... O-5704		<b>D80A</b> <b>(DOZERS)</b> <b>NT-855</b> Air Filter Secondary..... A-5610 Air Filter Primary..... A-5614 Coolant Filter..... WC-5707 Fuel Filter..... F-5601 Fuel Filter..... FC-5720 Fuel/Water Separator..... SFC-5705 Hydraulic Oil Filter..... H-56600 Hydraulic Oil Filter..... H-5610 Hydraulic Oil Filter..... H-5606 Oil Filter Full Flow..... C-5701 Oil Filter Full Flow..... C-5715 Oil Filter By Pass..... O-5704 Oil Filter Full Flow..... C-5605		<b>D80E-12</b> <b>(DOZERS)</b> <b>NH220-C1</b> Coolant Filter..... WC-5707 Fuel Filter..... F-5601 Hydraulic Oil Filter..... H-5607 Oil Filter Full Flow..... O-5603	
<b>D75S-5</b> <b>(LOADERS)</b> <b>S6D125</b> Fuel Filter..... FC-5606		<b>D80A-12</b> <b>(DOZERS)</b> <b>NH220</b> Air Filter Primary..... A-5637 Air Filter Primary..... A-5636 Coolant Filter..... WC-5711 Fuel Filter..... F-5601 Hydraulic Oil Filter..... H-5607 Hydraulic Oil Filter..... H-5504 Hydraulic Oil Filter..... H-55270 Oil Filter Full Flow..... O-5603 Oil Filter By Pass..... O-5704 Oil Filter Full Flow..... O-5702		<b>D80E-18</b> <b>(DOZERS)</b> <b>CUMMINS NT-855</b> Fuel Filter..... FC-5606  <b>D80E-18</b> <b>(DOZERS)</b> <b>NT-855</b> Air Filter Secondary..... A-5610 Air Filter Primary..... A-5614 Coolant Filter..... WC-5711 Fuel Filter..... FC-5602 Hydraulic Oil Filter..... H-56600 Hydraulic Oil Filter..... H-5610 Hydraulic Oil Filter..... H-5606 Oil Filter Full Flow..... C-5715 Oil Filter Full Flow..... C-5701 Oil Filter Full Flow..... C-5605 Oil Filter By Pass..... O-5704	
<b>D75S-5</b> <b>(LOADERS)</b> <b>S6D125/15001</b> Air Filter Secondary..... A-5408 Air Filter Primary..... A-6113 Fuel Filter..... FC-5602 Hydraulic Oil Filter..... H-56600 Hydraulic Oil Filter..... H-5610 Hydraulic Oil Filter..... H-5606 Oil Filter Full Flow..... C-5701 Oil Filter Full Flow..... C-5605 Oil Filter Full Flow..... C-5715		<b>D80A-12</b> <b>(DOZERS)</b> <b>NH220-C1</b> Coolant Filter..... WC-5707 Fuel Filter..... F-5601 Hydraulic Oil Filter..... H-5607 Hydraulic Oil Filter..... H-5606 Oil Filter Full Flow..... O-5603		<b>D80P</b> <b>(DOZERS)</b> <b>NT-855</b> Air Filter Secondary..... A-5610 Air Filter Primary..... A-5614 Coolant Filter..... WC-5707	
<b>D80-12</b> <b>(DOZERS)</b> <b>CUMMINS</b> Air Filter Primary..... A-5636 Coolant Filter..... WC-5711 Fuel Filter..... F-5601 Hydraulic Oil Filter..... H-5610 Hydraulic Oil Filter..... H-55270 Hydraulic Oil Filter..... H-56600 Hydraulic Oil Filter..... H-5504 Oil Filter Full Flow..... O-5603 Oil Filter By Pass..... O-5704					

# Sakura Filter

# ENGINE APPLICATION

MODEL/APPLICATION	SAKURA NO	MODEL/APPLICATION	SAKURA NO	MODEL/APPLICATION	SAKURA NO
<b>KOMATSU</b>		<b>KOMATSU</b>		<b>KOMATSU</b>	
<b>D80P</b> (DOZERS) NT-855		Hydraulic Oil Filter.....	H-5620	<b>D85A</b> (DOZERS) NT-855	
Fuel Filter.....	FC-5720	Hydraulic Oil Filter.....	H-5601	Air Filter Secondary.....	A-5610
Fuel Filter.....	F-5601	Oil Filter Full Flow.....	C-5715	Air Filter Primary.....	A-5614
Fuel/Water Separator.....	SFC-5705	Oil Filter Full Flow.....	C-5701	Coolant Filter.....	WC-5707
Hydraulic Oil Filter.....	H-5610	Oil Filter Full Flow.....	C-5605	Fuel Filter.....	FC-5720
Hydraulic Oil Filter.....	H-56600	<b>D83E-1</b> (DOZERS) S6D125		Fuel Filter.....	F-5601
Hydraulic Oil Filter.....	H-5606	Fuel Filter.....	FC-5606	Fuel/Water Separator.....	SFC-5705
Oil Filter Full Flow.....	C-5701	<b>D83E-1</b> (DOZERS) S6D125-1/1001		Hydraulic Oil Filter.....	H-5610
Oil Filter By Pass.....	O-5704	Air Filter Secondary.....	A-5408	Hydraulic Oil Filter.....	H-56600
Oil Filter Full Flow.....	C-5605	Air Filter Primary.....	A-6113	Hydraulic Oil Filter.....	H-5606
Oil Filter Full Flow.....	C-5715	Fuel Filter.....	FC-5602	Oil Filter Full Flow.....	C-5605
<b>D80P-12</b> (DOZERS) NTO-6-C1		Hydraulic Oil Filter.....	H-5601	Oil Filter By Pass.....	O-5704
Air Filter Secondary.....	A-5408	Hydraulic Oil Filter.....	H-5620	Oil Filter Full Flow.....	C-5715
Air Filter Primary.....	A-6113	Oil Filter Full Flow.....	C-5605	Oil Filter Full Flow.....	C-5701
Coolant Filter.....	WC-5707	Oil Filter Full Flow.....	C-5701	<b>D85A-12</b> (DOZERS) NH220C1	
Fuel Filter.....	F-5601	Oil Filter Full Flow.....	C-5715	Fuel Filter.....	F-5601
Hydraulic Oil Filter.....	H-5504	<b>D83P-1</b> (DOZERS) S6D125		Hydraulic Oil Filter.....	H-5607
Hydraulic Oil Filter.....	H-5607	Fuel Filter.....	FC-5606	Hydraulic Oil Filter.....	H-5606
Hydraulic Oil Filter.....	H-55270	<b>D83P-1</b> (DOZERS) S6D125-1/1001		Oil Filter Full Flow.....	O-5603
Oil Filter Full Flow.....	O-5603	Air Filter Primary.....	A-6113	<b>D85A-18</b> (DOZERS) CUMMINS NT-855	
Oil Filter By Pass.....	O-5704	Air Filter Secondary.....	A-5408	Fuel Filter.....	FC-5606
<b>D80P-18</b> (DOZERS) CUMMINS NT-855		Fuel Filter.....	FC-5602	<b>D85A-18</b> (DOZERS) NT-855/25001	
Fuel Filter.....	FC-5606	Hydraulic Oil Filter.....	H-5601	Air Filter Secondary.....	A-5610
<b>D82E</b> (DOZERS) NT-855		Hydraulic Oil Filter.....	H-5620	Air Filter Primary.....	A-5614
Air Filter Secondary.....	A-5610	Oil Filter Full Flow.....	C-5605	Fuel Filter.....	F-5601
Air Filter Primary.....	A-5614	Oil Filter Full Flow.....	C-5701	Fuel Filter.....	FC-5602
Coolant Filter.....	WC-5707	Oil Filter Full Flow.....	C-5715	Hydraulic Oil Filter.....	H-5610
Fuel Filter.....	F-5601	<b>D85</b> (DOZERS) 148		Hydraulic Oil Filter.....	H-56600
Fuel Filter.....	FC-5720	Fuel Filter.....	F-2622	Hydraulic Oil Filter.....	H-5606
Fuel/Water Separator.....	SFC-5705	Oil Filter Full Flow.....	C-1122	Oil Filter Full Flow.....	C-5715
Hydraulic Oil Filter.....	H-5606	<b>D85-18</b> (DOZERS) NT-855/25001		Oil Filter Full Flow.....	C-5605
Hydraulic Oil Filter.....	H-5610	Air Filter Secondary.....	A-5610	Oil Filter Full Flow.....	C-5701
Hydraulic Oil Filter.....	H-56600	Air Filter Primary.....	A-5614	Oil Filter By Pass.....	O-5704
Oil Filter Full Flow.....	C-5701	Fuel Filter.....	FC-5602	<b>D85A-21</b> (DOZERS) S6D125	
Oil Filter Full Flow.....	C-5715	Hydraulic Oil Filter.....	H-5610	Fuel Filter.....	FC-5606
Oil Filter By Pass.....	O-5704	Hydraulic Oil Filter.....	H-56600	<b>D85A-21</b> (DOZERS) S6D125/35001	
Oil Filter Full Flow.....	C-5605	Hydraulic Oil Filter.....	H-5606	Air Filter Secondary.....	A-5408
<b>D82E-18</b> (DOZERS) NT-855		Oil Filter Full Flow.....	C-5715	Air Filter Primary.....	A-6113
Air Filter Secondary.....	A-5610	Oil Filter By Pass.....	O-5704	Fuel Filter.....	FC-5602
Air Filter Primary.....	A-5614	Oil Filter Full Flow.....	C-5701	Hydraulic Oil Filter.....	H-56600
Coolant Filter.....	WC-5711	Oil Filter Full Flow.....	C-5701	Hydraulic Oil Filter.....	H-5610
Fuel Filter.....	FC-5602	Oil Filter Full Flow.....	C-5605	Hydraulic Oil Filter.....	H-5606
Hydraulic Oil Filter.....	H-56600	<b>D85-21</b> (DOZERS) 35001		Oil Filter Full Flow.....	C-5715
Hydraulic Oil Filter.....	H-5610	Air Filter Secondary.....	A-5408	Oil Filter Full Flow.....	C-5605
Hydraulic Oil Filter.....	H-5606	Air Filter Primary.....	A-6113	Oil Filter Full Flow.....	C-5701
Oil Filter Full Flow.....	C-5715	Fuel Filter.....	FC-5602	<b>D85B</b> (DOZERS) 148	
Oil Filter By Pass.....	O-5704	Hydraulic Oil Filter.....	H-56600	Fuel Filter.....	F-2622
Oil Filter Full Flow.....	C-5701	Hydraulic Oil Filter.....	H-5610	Oil Filter Full Flow.....	C-1122
Oil Filter Full Flow.....	C-5605	Hydraulic Oil Filter.....	H-5606	<b>D85C-12</b> (DOZERS) NH220	
<b>D83-1</b> (DOZERS) S/N: 1001		Oil Filter Full Flow.....	C-5605	Air Filter Secondary.....	A-5408
Air Filter Secondary.....	A-5408	Oil Filter Full Flow.....	C-5701	Air Filter Primary.....	A-6113
Fuel Filter.....	FC-5602	Oil Filter Full Flow.....	C-5715	Fuel Filter.....	FC-5602

MODEL/APPLICATION	SAKURA NO	MODEL/APPLICATION	SAKURA NO	MODEL/APPLICATION	SAKURA NO
<b>KOMATSU</b>		<b>KOMATSU</b>		<b>KOMATSU</b>	
<b>D85C-12 (DOZERS) NH220</b>		<b>D85E-SS-2A (DOZERS) S6D125</b>		<b>D85P-18 (DOZERS) NT-855/2001</b>	
Coolant Filter.....	WC-5711	Air Filter Secondary.....	A-5408	Air Filter Primary.....	A-5614
Fuel Filter.....	F-5601	Air Filter Primary.....	A-6113	Air Filter Secondary.....	A-5610
Oil Filter Full Flow.....	O-5603	Fuel Filter.....	FC-5602	Fuel Filter.....	FC-5602
Oil Filter By Pass.....	O-5704	Fuel Filter.....	FC-5606	Fuel Filter.....	F-5601
<b>D85E (DOZERS) NT-855</b>		<b>D85E-SS-2A (DOZERS) S6D125E-2H-6</b>		<b>D85P-21 (DOZERS) S6D125</b>	
Air Filter Secondary.....	A-5610	Hydraulic Oil Filter.....	H-56600	Air Filter Primary.....	A-6113
Air Filter Primary.....	A-5614	Hydraulic Oil Filter.....	H-5607	Air Filter Secondary.....	A-5408
Coolant Filter.....	WC-5707	Hydraulic Oil Filter.....	H-5610	Fuel Filter.....	FC-5606
Fuel Filter.....	F-5601	Oil Filter Full Flow.....	C-5701	Fuel Filter.....	FC-5602
Fuel Filter.....	FC-5720	Oil Filter Full Flow.....	C-5605	Hydraulic Oil Filter.....	H-5606
Fuel/Water Separator.....	SFC-5705	Oil Filter Full Flow.....	C-5715	Hydraulic Oil Filter.....	H-5610
Hydraulic Oil Filter.....	H-5610	<b>D85EX-15 (DOZERS) SA6D125E , 2004-2007</b>		Hydraulic Oil Filter.....	H-56600
Hydraulic Oil Filter.....	H-56600	Fuel Filter.....	FC-5606	Hydraulic Oil Filter.....	H-5610
Hydraulic Oil Filter.....	H-5606	<b>D85EX-15SL (DOZERS) SA6D125E , 2004</b>		Hydraulic Oil Filter.....	H-56600
Oil Filter Full Flow.....	C-5605	Air Filter Set.....	A-5558M-S	Oil Filter Full Flow.....	C-5701
Oil Filter Full Flow.....	C-5701	Air Filter Primary.....	A-5558M	Oil Filter Full Flow.....	C-5715
Oil Filter By Pass.....	O-5704	Air Filter Secondary.....	A-5559	Oil Filter Full Flow.....	C-5605
Oil Filter Full Flow.....	C-5715	Cabin Air Filter.....	CA-5602	<b>D85P-21 (DOZERS) S6D125/3001</b>	
<b>D85E-12 (DOZERS) NH220C1</b>		Cabin Air Filter.....	CA-56041	Air Filter Secondary.....	A-5408
Fuel Filter.....	F-5601	Hydraulic Oil Filter.....	H-5646	Air Filter Primary.....	A-6113
Hydraulic Oil Filter.....	H-5607	Hydraulic Oil Filter.....	H-5629	Fuel Filter.....	FC-5602
Hydraulic Oil Filter.....	H-5606	<b>D85EX-15SL (DOZERS) SA6D125E , 2004</b>		Hydraulic Oil Filter.....	H-56600
Oil Filter Full Flow.....	O-5603	Air Filter Primary.....	A-5558M	Hydraulic Oil Filter.....	H-5610
<b>D85E-18 (DOZERS) CUMMINS NT-855</b>		Air Filter Secondary.....	A-5559	Hydraulic Oil Filter.....	H-5606
Fuel Filter.....	FC-5606	Air Filter Set.....	A-5558M-S	Hydraulic Oil Filter.....	H-5610
<b>D85E-18 (DOZERS) NT-855/25001</b>		Cabin Air Filter.....	CA-56041	Oil Filter Full Flow.....	C-5701
Air Filter Secondary.....	A-5610	Cabin Air Filter.....	CA-5602	Oil Filter Full Flow.....	C-5715
Air Filter Primary.....	A-5614	Hydraulic Oil Filter.....	H-5629	Oil Filter Full Flow.....	C-5605
Fuel Filter.....	FC-5602	Hydraulic Oil Filter.....	H-5646	<b>D85PX (DOZERS)</b>	
Fuel Filter.....	F-5601	<b>D85P-12 (DOZERS) NH220-C1</b>		Fuel Filter.....	FC-56300
Hydraulic Oil Filter.....	H-56600	Coolant Filter.....	WC-5707	Fuel/Water Separator Secondary..	SFC-5611-10
Hydraulic Oil Filter.....	H-5610	Fuel Filter.....	F-5601	Fuel/Water Separator Secondary..	SFC-5611-10B
Hydraulic Oil Filter.....	H-5606	Hydraulic Oil Filter.....	H-5607	Hydraulic Oil Filter.....	H-5646
Oil Filter Full Flow.....	C-5715	Oil Filter Full Flow.....	O-5603	Hydraulic Oil Filter.....	H-5610
Oil Filter Full Flow.....	C-5701	<b>D85P-18 (DOZERS) CUMMINS NT-855</b>		Hydraulic Oil Filter.....	H-5629
Oil Filter By Pass.....	O-5704	Fuel Filter.....	FC-5606	Hydraulic Oil Filter.....	H-56600
Oil Filter Full Flow.....	C-5605	<b>D85P-18 (DOZERS) NT-855</b>		<b>D85PX-15 (DOZERS) SA6D125E , 2004-2007</b>	
<b>D85E-21 (DOZERS) S6D125</b>		Air Filter Secondary.....	A-5610	Air Filter Set.....	A-5558M-S
Fuel Filter.....	FC-5606	Air Filter Primary.....	A-5614	Air Filter Primary.....	A-5558M
<b>D85E-21 (DOZERS) S6D125/35001</b>		Coolant Filter.....	WC-5707	Air Filter Secondary.....	A-5559
Air Filter Secondary.....	A-5408	Fuel Filter.....	FC-5720	Cabin Air Filter.....	CA-56041
Air Filter Primary.....	A-6113	Fuel Filter.....	F-5601	Cabin Air Filter.....	CA-5602
Fuel Filter.....	FC-5602	Fuel/Water Separator.....	SFC-5705	Hydraulic Oil Filter.....	H-5646
Hydraulic Oil Filter.....	H-5606	Hydraulic Oil Filter.....	H-5610	Hydraulic Oil Filter.....	H-5629
Hydraulic Oil Filter.....	H-5610	Hydraulic Oil Filter.....	H-5606	Hydraulic Oil Filter.....	H-5610
Hydraulic Oil Filter.....	H-56600	Hydraulic Oil Filter.....	H-56600	Oil Filter Full Flow.....	C-5701
Oil Filter Full Flow.....	C-5605	Oil Filter By Pass.....	O-5704	Oil Filter Full Flow.....	C-5715
Oil Filter Full Flow.....	C-5715	Oil Filter Full Flow.....	C-5605	Oil Filter Full Flow.....	C-5605
Oil Filter Full Flow.....	C-5701	Oil Filter Full Flow.....	C-5701	<b>D85EX-15E0 (DOZERS) SAA6D125E-5</b>	
<b>D85E-21 (DOZERS) S6D125</b>		<b>D85P-18 (DOZERS) NT-855</b>		Air Filter Secondary.....	A-5559
Fuel Filter.....	FC-5606	Air Filter Secondary.....	A-5610	Air Filter Set.....	A-5558M-S
<b>D85E-21 (DOZERS) S6D125/35001</b>		Air Filter Primary.....	A-5614	<b>D85EX-15E0 (DOZERS) SAA6D125E-5</b>	
Air Filter Secondary.....	A-5408	Coolant Filter.....	WC-5707	Air Filter Secondary.....	A-5559
Air Filter Primary.....	A-6113	Fuel Filter.....	FC-5720	Air Filter Set.....	A-5558M-S
Fuel Filter.....	FC-5602	Fuel Filter.....	F-5601	<b>D85EX-15E0 (DOZERS) SAA6D125E-5</b>	
Hydraulic Oil Filter.....	H-5606	Fuel/Water Separator.....	SFC-5705	Air Filter Secondary.....	A-5559
Hydraulic Oil Filter.....	H-5610	Hydraulic Oil Filter.....	H-5610	Air Filter Set.....	A-5558M-S
Hydraulic Oil Filter.....	H-56600	Hydraulic Oil Filter.....	H-5606	<b>D85EX-15E0 (DOZERS) SAA6D125E-5</b>	
Oil Filter Full Flow.....	C-5605	Hydraulic Oil Filter.....	H-56600	Air Filter Secondary.....	A-5559
Oil Filter Full Flow.....	C-5715	Oil Filter By Pass.....	O-5704	Air Filter Set.....	A-5558M-S
Oil Filter Full Flow.....	C-5701	Oil Filter Full Flow.....	C-5715	<b>D85EX-15E0 (DOZERS) SAA6D125E-5</b>	
Oil Filter Full Flow.....	C-5701	Oil Filter Full Flow.....	C-5605	Air Filter Secondary.....	A-5559
Oil Filter Full Flow.....	C-5701	Oil Filter Full Flow.....	C-5701	Air Filter Set.....	A-5558M-S

MODEL/APPLICATION	SAKURA NO	MODEL/APPLICATION	SAKURA NO	MODEL/APPLICATION	SAKURA NO
<b>KOMATSU</b>		<b>KOMATSU</b>		<b>KOMATSU</b>	
<b>D85EX-15E0</b> (DOZERS) SAA6D125E-5		<b>D95S-2</b> (DOZERS) NT-855/2001		<b>DF10C</b> (ASPHALT PAVER) F4L912	
Air Filter Primary.....	A-5558M	Air Filter Primary.....	A-5614	Fuel Filter.....	FC-5704
Cabin Air Filter.....	CA-5602	Air Filter Secondary.....	A-5610	Oil Filter Full Flow.....	C-6202
Cabin Air Filter.....	CA-56041	Fuel Filter.....	FC-5602		
Fuel/Water Separator Secondary..	SFC-5611-10	Hydraulic Oil Filter.....	H-56600	<b>DF10P</b> (ASPHALT PAVER) F4L912	
Fuel/Water Separator Secondary..	SFC-5611-10B	Hydraulic Oil Filter.....	H-5610	Fuel Filter.....	FC-5704
Hydraulic Oil Filter.....	H-5629	Hydraulic Oil Filter.....	H-5606	Oil Filter Full Flow.....	C-6202
Hydraulic Oil Filter.....	H-5646	Oil Filter Full Flow.....	C-5715		
		Oil Filter Full Flow.....	C-5701	<b>DF110P</b> (ASPHALT PAVER) F6L912	
<b>D85EX-15R</b> (DOZERS) SA6D125E , 2004-2007		Oil Filter Full Flow.....	C-5605	Fuel Filter Primary.....	A-6211
Air Filter Primary.....	A-5558M	Oil Filter By Pass.....	O-5704	Air Filter Secondary.....	A-6212
Air Filter Secondary.....	A-5559			Fuel Filter.....	FC-5704
Air Filter Set.....	A-5558M-S	<b>DA85A-12</b> (DOZERS) NH220		Oil Filter Full Flow.....	C-6204
Cabin Air Filter.....	CA-5602	Air Filter Primary.....	A-5623		
Cabin Air Filter.....	CA-56041	Air Filter Secondary.....	A-5624	<b>DF120C</b> (ASPHALT PAVER) F6L912	
Hydraulic Oil Filter.....	H-5646	Air Filter Set.....	A-5622-S	Air Filter Primary.....	A-6211
Hydraulic Oil Filter.....	H-5629	Coolant Filter.....	WC-5711	Air Filter Secondary.....	A-6212
		Fuel Filter.....	F-5601	Fuel Filter.....	FC-5704
<b>D85E-SS-2</b> (DOZERS)		Hydraulic Oil Filter.....	H-55270	Oil Filter Full Flow.....	C-6204
Fuel Filter.....	F-56060	Hydraulic Oil Filter.....	H-5504		
		Hydraulic Oil Filter.....	H-5607	<b>DF12C</b> (ASPHALT PAVER) F5L912	
<b>D85E-SS-2</b> (DOZERS) S6D125E-2G-6		Oil Filter Full Flow.....	O-5603	Fuel Filter.....	FC-5704
Fuel Filter.....	FC-5606	Oil Filter By Pass.....	O-5704	Oil Filter Full Flow.....	C-6204
<b>D90 SERIES C</b> (LOADERS) 6V-53		<b>DDC045</b> (DOZERS)		<b>DF12C</b> (ASPHALT PAVER) F6L912	
Air Filter.....	A-57240	Hydraulic Oil Filter.....	H-5608	Fuel Filter.....	FC-5704
Fuel Filter.....	F-6505			Oil Filter Full Flow.....	C-6204
Fuel Filter Secondary.....	F-6502	<b>DDC050</b> (DOZERS)			
Oil Filter Full Flow.....	O-6503	Hydraulic Oil Filter.....	H-5608	<b>DF12P</b> (ASPHALT PAVER) F5L912	
				Fuel Filter.....	FC-5704
<b>D90 SERIES C</b> (LOADERS) DT573		<b>DDC060</b> (DOZERS)		Oil Filter Full Flow.....	C-6204
Air Filter.....	AS-5707	Hydraulic Oil Filter.....	H-5601		
Hydraulic Oil Filter Transmission...	H-65030			<b>DF12P</b> (ASPHALT PAVER) F6L912	
		<b>DDM045</b> (DOZERS)		Fuel Filter.....	FC-5704
<b>D90 SERIES C</b> (LOADERS) V6R-180		Hydraulic Oil Filter.....	H-5608	Oil Filter Full Flow.....	C-6204
Fuel Filter.....	FC-1303				
Fuel Filter.....	FC-5720	<b>DDM060</b> (DOZERS)		<b>DF15</b> (FORKLIFTS)	
Fuel Filter.....	F-5701	Hydraulic Oil Filter.....	H-5601	Fuel Filter.....	FC-5704
Fuel/Water Separator.....	SFC-5705	Hydraulic Oil Filter.....	H-5608	Oil Filter Full Flow.....	C-6204
Hydraulic Oil Filter Transmission...	H-65030				
		<b>DDR040</b> (DOZERS)		<b>DF5C</b> (ASPHALT PAVER) F2L912	
<b>D95S-1</b> (DOZERS) S4D155		Hydraulic Oil Filter.....	H-5608	Fuel Filter.....	FC-6205
Air Filter Primary.....	A-6113				
Air Filter Secondary.....	A-5408	<b>DF100C</b> (ASPHALT PAVER) F4L912		<b>DF8P</b> (ASPHALT PAVER) F3L912	
Coolant Filter.....	WC-5707	Air Filter Primary.....	A-6211	Fuel Filter.....	FC-5704
Fuel Filter.....	F-2626	Air Filter Secondary.....	A-6212	Oil Filter Full Flow.....	C-6202
Hydraulic Oil Filter.....	H-55270	Fuel Filter.....	FC-5704		
Hydraulic Oil Filter.....	H-56600	Oil Filter Full Flow.....	C-6202	<b>DX37EX-21A</b> (DOZERS) KOMATSU SAA4D102E	
Hydraulic Oil Filter.....	H-5504			Air Filter Primary.....	A-56731
Hydraulic Oil Filter.....	H-5610	<b>DF100P</b> (ASPHALT PAVER) F4L912		Air Filter Set.....	A-56731-S
Oil Filter Full Flow.....	O-5601	Air Filter Secondary.....	A-6212	Air Filter Secondary.....	A-56741
Oil Filter By Pass.....	O-5704	Air Filter Primary.....	A-6211		
		Fuel Filter.....	FC-5704	<b>DX37EX-21A</b> (DOZERS) SAA4D102E	
<b>D95S-2</b> (DOZERS) CUMMINS NT-855		Oil Filter Full Flow.....	C-6202	Air Filter Set.....	A-5675-S
Fuel Filter.....	FC-5606				

MODEL/APPLICATION	SAKURA NO	MODEL/APPLICATION	SAKURA NO	MODEL/APPLICATION	SAKURA NO
<b>KOMATSU</b>		<b>KOMATSU</b>		<b>KOMATSU</b>	
<b>DX37EX-21A</b> (DOZERS) SAA4D102E		<b>F1900</b> (MOTOR GRADERS) 6V-71		<b>FD20</b> (FORKLIFTS) G150	
Air Filter Primary.....	A-5673	Fuel Filter.....	F-7302	Oil Filter Full Flow.....	O-1803
Air Filter Secondary.....	A-8670	Fuel Filter.....	F-6503		
Cabin Air Filter.....	CA-56041	Oil Filter Full Flow.....	O-6503	<b>FD20</b> (FORKLIFTS) G207	
Fuel Filter.....	F-5218			Oil Filter Full Flow.....	O-1803
<b>E200</b> (MOTOR GRADERS) DT361		<b>F240</b> (DOZERS)		<b>FD20</b> (FORKLIFTS)	
Fuel Filter.....	FC-1810	Fuel Filter.....	FC-5103	Air Filter Set.....	AS-5644-S
Fuel/Water Separator.....	SFC-5705	<b>F240D</b> (DOZERS)		Air Filter Primary.....	AS-5644
<b>E200</b> (MOTOR GRADERS) DT407		Fuel Filter.....	FC-5103	Fuel Filter.....	FC-1802
Fuel Filter.....	FC-1810	<b>F265D</b> (DOZERS)		<b>FD20-10</b> (FORKLIFTS) 4D95	
Fuel/Water Separator.....	SFC-5705	Fuel Filter.....	FC-5103	Air Filter.....	A-8568
<b>E200</b> (SCRAPERS) DT414		<b>F267D</b> (DOZERS)		Air Filter Set.....	AS-5643-S
Air Filter Primary.....	A-5413	Fuel Filter.....	FC-5103	Air Filter Primary.....	AS-5643
Air Filter Secondary.....	A-5414	<b>F270</b> (DOZERS)		<b>FD20-5</b> (FORKLIFTS) C-175	
Air Filter Set.....	A-5660-S	Fuel Filter.....	FC-5103	Oil Filter Full Flow.....	O-1901
Fuel Filter.....	FC-7933	<b>F270D</b> (DOZERS)		<b>FD20-5</b> (FORKLIFTS) DL201	
Fuel/Water Separator.....	SFC-5705	Fuel Filter.....	FC-5103	Oil Filter Full Flow.....	O-1901
<b>E200</b> (SCRAPERS) DT466		<b>FC45</b> (LOADERS)		<b>FD20L-10</b> (FORKLIFTS) 4D95	
Air Filter Primary.....	A-5413	Air Filter Primary.....	AS-2205	Air Filter.....	A-8568
Air Filter Secondary.....	A-5414	Fuel Filter.....	F-5210	Air Filter Primary.....	AS-5643
Air Filter Set.....	A-5660-S	<b>FCD UTILITY</b> (TRACTORS)		Air Filter Set.....	AS-5643-S
Fuel Filter.....	FC-7933	Fuel Filter.....	F-2601	<b>FD20S</b> (FORKLIFTS)	
Fuel/Water Separator.....	SFC-5705	Fuel Filter.....	FC-5103	Air Filter Set.....	AS-5644-S
<b>E211</b> (SCRAPERS) D407		<b>FD10</b> (FORKLIFTS) 4D95		Air Filter Primary.....	AS-5644
Fuel/Water Separator.....	SFC-5705	Air Filter.....	A-8568	Fuel Filter.....	FC-1802
<b>E-270</b> (MOTOR GRADERS) DVT-573		Air Filter Set.....	AS-5643-S	<b>FD20S-5</b> (FORKLIFTS) 4D95	
Air Filter.....	A-5410	Air Filter Primary.....	AS-5643	Air Filter.....	A-8568
Fuel Filter.....	FC-1810	<b>FD100</b> (FORKLIFTS)		Air Filter Primary.....	AS-5643
Fuel/Water Separator.....	SFC-5705	Oil Filter Full Flow.....	C-5614	Air Filter Set.....	AS-5643-S
Hydraulic Oil Filter Transmission...	H-65030	<b>FD115</b> (FORKLIFTS)		<b>FD20SV</b> (FORKLIFTS)	
<b>ET200</b> (MOTOR GRADERS) DT361		Oil Filter Full Flow.....	C-5614	Air Filter Set.....	AS-5644-S
Fuel Filter.....	FC-1810	<b>FD135-4</b> (FORKLIFTS)		Air Filter Primary.....	AS-5644
Fuel/Water Separator.....	SFC-5705	Oil Filter Full Flow.....	C-5614	Fuel Filter.....	FC-1802
<b>ET200</b> (MOTOR GRADERS) DT407		<b>FD150E-7</b> (FORKLIFTS) S/N: 6089 & 6075 , 2005		<b>FD20SV-11</b> (FORKLIFTS)	
Fuel Filter.....	FC-1810	Fuel Filter.....	FC-1503	Air Filter Set.....	AS-5644-S
Fuel/Water Separator.....	SFC-5705	<b>FD15T-20</b> (FORKLIFTS) 4D92E-08571		Air Filter Primary.....	AS-5644
<b>F135D</b> (DOZERS)		Oil Filter Full Flow.....	C-1720	Fuel Filter.....	FC-1802
Fuel Filter.....	FC-5103	<b>FD20</b> (FORKLIFTS) C221		<b>FD20V-11</b> (FORKLIFTS)	
<b>F137D</b> (DOZERS)		Oil Filter Full Flow.....	O-1803	Air Filter Set.....	AS-5644-S
Fuel Filter.....	FC-5103	<b>FD23-10</b> (FORKLIFTS) 4D95		Air Filter Primary.....	AS-5644
<b>F1500</b> (MOTOR GRADERS) 4-71		Air Filter.....	A-8568	Fuel Filter.....	FC-1802
Fuel Filter.....	F-6505				
Fuel Filter Secondary.....	F-6502				
Oil Filter Full Flow.....	O-6503				

# Sakura Filter

# ENGINE APPLICATION

MODEL/APPLICATION	SAKURA NO	MODEL/APPLICATION	SAKURA NO	MODEL/APPLICATION	SAKURA NO
<b>KOMATSU</b>		<b>KOMATSU</b>		<b>KOMATSU</b>	
<b>FD23-10</b> ( <i>FORKLIFTS</i> ) 4D95		<b>FD25ST-5 CONSOLIDATED</b> ( <i>FORKLIFTS</i> )		<b>FD20-11</b> ( <i>FORKLIFTS</i> ) KOMATSU-4D94LE	
Air Filter Primary.....	AS-5643	Air Filter.....	A-8568	Hydraulic Oil Filter.....	H-5632
Air Filter Set.....	AS-5643-S	Air Filter Primary.....	AS-5643		
		Air Filter Set.....	AS-5643-S		
<b>FD25</b> ( <i>FORKLIFTS</i> ) C221		Fuel Filter.....	FC-1802	<b>FD30</b> ( <i>FORKLIFTS</i> ) C221	
Oil Filter Full Flow.....	0-1803			Oil Filter Full Flow.....	0-1803
		<b>FD25SV</b> ( <i>FORKLIFTS</i> )		<b>FD30</b> ( <i>FORKLIFTS</i> ) G150	
<b>FD25</b> ( <i>FORKLIFTS</i> ) G150		Air Filter Set.....	AS-5644-S	Oil Filter Full Flow.....	0-1803
Oil Filter Full Flow.....	0-1803	Air Filter Primary.....	AS-5644		
		Fuel Filter.....	FC-1802	<b>FD30</b> ( <i>FORKLIFTS</i> ) G207	
<b>FD25</b> ( <i>FORKLIFTS</i> ) G207				Oil Filter Full Flow.....	0-1803
Oil Filter Full Flow.....	0-1803	<b>FD25V</b> ( <i>FORKLIFTS</i> )			
		Air Filter Set.....	AS-5644-S	<b>FD30</b> ( <i>FORKLIFTS</i> ) ISUZU DA640	
<b>FD25</b> ( <i>FORKLIFTS</i> )		Air Filter Primary.....	AS-5644	Air Filter.....	A-6003
Air Filter Set.....	AS-5644-S	Fuel Filter.....	FC-1802		
Air Filter Primary.....	AS-5644			<b>FD30-10</b> ( <i>FORKLIFTS</i> ) 4D95	
Fuel Filter.....	FC-1802	<b>FD25V-11</b> ( <i>FORKLIFTS</i> )		Air Filter Set.....	AS-5643-S
		Air Filter Set.....	AS-5644-S	Air Filter.....	A-8568
<b>FD25-1</b> ( <i>FORKLIFTS</i> ) C-175		Air Filter Primary.....	AS-5644	Air Filter Primary.....	AS-5643
Oil Filter Full Flow.....	0-1901	Fuel Filter.....	FC-1802		
				<b>FD30-11</b> ( <i>FORKLIFTS</i> ) KOMATSU-4D94LE	
<b>FD25-1</b> ( <i>FORKLIFTS</i> ) DL201		<b>FD28-10</b> ( <i>FORKLIFTS</i> ) 4D95		Hydraulic Oil Filter.....	H-5632
Oil Filter Full Flow.....	0-1901	Air Filter Set.....	AS-5643-S		
		Air Filter.....	A-8568	<b>FD30-11</b> ( <i>FORKLIFTS</i> )	
<b>FD25-10</b> ( <i>FORKLIFTS</i> ) 4D95		Air Filter Primary.....	AS-5643	Air Filter Set.....	AS-5644-S
Air Filter Set.....	AS-5643-S			Air Filter Primary.....	AS-5644
Air Filter.....	A-8568	<b>FD25-14</b> ( <i>FORKLIFTS</i> ) 4D94LE		Fuel Filter.....	FC-1802
Air Filter Primary.....	AS-5643	Air Filter Primary.....	A-8505		
				<b>FD305-5</b> ( <i>FORKLIFTS</i> ) 4D95	
<b>FD25L-10</b> ( <i>FORKLIFTS</i> ) 4D95		<b>FD25-17</b> ( <i>FORKLIFTS</i> ) 4D94LE		Air Filter.....	A-8568
Air Filter Set.....	AS-5643-S	Air Filter Primary.....	A-8505	Air Filter Primary.....	AS-5643
Air Filter.....	A-8568			Air Filter Set.....	AS-5643-S
Air Filter Primary.....	AS-5643	<b>FD20-16</b> ( <i>FORKLIFTS</i> ) 4D94LE			
		Air Filter Primary.....	A-8505	<b>FD30H-11</b> ( <i>FORKLIFTS</i> )	
<b>FD25S</b> ( <i>FORKLIFTS</i> )				Air Filter Set.....	AS-5644-S
Air Filter Set.....	AS-5644-S	<b>FD20-17</b> ( <i>FORKLIFTS</i> ) 4D94LE		Air Filter Primary.....	AS-5644
Air Filter Primary.....	AS-5644	Air Filter Primary.....	A-8505	Fuel Filter.....	FC-1802
Fuel Filter.....	FC-1802				
<b>FD25S-5</b> ( <i>FORKLIFTS</i> ) 4D95		<b>FD20T-16R</b> ( <i>FORKLIFTS</i> ) 4D94LE , 2007		<b>FD30J-12</b> ( <i>FORKLIFTS</i> ) C240	
Air Filter Set.....	AS-5643-S	Fuel Filter.....	FC-5604	Fuel Filter.....	FC-1006
Air Filter.....	A-8568	Oil Filter Full Flow.....	C-5606		
Air Filter Primary.....	AS-5643			<b>FD30S-11</b> ( <i>FORKLIFTS</i> )	
		<b>FD25-16</b> ( <i>FORKLIFTS</i> ) 4D94LE		Air Filter Set.....	AS-5644-S
<b>FD25S-5</b> ( <i>FORKLIFTS</i> )		Air Filter Primary.....	A-8505	Air Filter Primary.....	AS-5644
Oil Filter Full Flow.....	C-5615			Fuel Filter.....	FC-1802
Oil Filter Full Flow.....	C-5616	<b>FD25T-12</b> ( <i>FORKLIFTS</i> ) 2002			
		Air Filter Secondary.....	A-8599	<b>FD30SV-11</b> ( <i>FORKLIFTS</i> )	
<b>FD25S-5 ROADWAY</b> ( <i>FORKLIFTS</i> )				Air Filter Set.....	AS-5644-S
Air Filter.....	A-8568	<b>FD25T-16</b> ( <i>FORKLIFTS</i> )		Air Filter Primary.....	AS-5644
Air Filter Set.....	AS-5643-S	Air Filter Primary.....	A-8505	Fuel Filter.....	FC-1802
Air Filter Primary.....	AS-5643				
Fuel Filter.....	FC-1802	<b>FD25T-16R</b> ( <i>FORKLIFTS</i> ) 4D94LE , 2007		<b>FD30V-11</b> ( <i>FORKLIFTS</i> )	
		Fuel Filter.....	FC-5604	Air Filter Set.....	AS-5644-S
		Oil Filter Full Flow.....	C-5606	Air Filter Primary.....	AS-5644

# Sakura Filter

# ENGINE APPLICATION

MODEL/APPLICATION	SAKURA NO	MODEL/APPLICATION	SAKURA NO	MODEL/APPLICATION	SAKURA NO
<b>KOMATSU</b>		<b>KOMATSU</b>		<b>KOMATSU</b>	
<b>FD30V-11</b> ( <i>FORKLIFTS</i> )		<b>FG10</b> ( <i>FORKLIFTS</i> ) 4P		<b>FG15</b> ( <i>FORKLIFTS</i> ) G207	
Fuel Filter.....	FC-1802	Air Filter.....	AS-5412	Oil Filter Full Flow.....	O-1803
<b>FD33</b> ( <i>FORKLIFTS</i> ) 6D95L		Air Filter.....	A-1004	<b>FG15</b> ( <i>FORKLIFTS</i> ) J15	
Hydraulic Oil Filter.....	HC-7901	Oil Filter Full Flow.....	C-1122	Air Filter Primary.....	AS-2205
<b>FD35</b> ( <i>FORKLIFTS</i> ) 6D95L		<b>FG10</b> ( <i>FORKLIFTS</i> ) D11		Oil Filter Full Flow.....	C-1829
Hydraulic Oil Filter.....	HC-7901	Air Filter Primary.....	AS-2205	<b>FG18</b> ( <i>FORKLIFTS</i> ) 4P	
<b>FD35N</b> ( <i>FORKLIFTS</i> ) 6D95L		Oil Filter Full Flow.....	C-1829	Air Filter.....	AS-5412
Hydraulic Oil Filter.....	HC-7901	<b>FG10</b> ( <i>FORKLIFTS</i> ) DPU 40DA		Air Filter.....	A-1004
<b>FD30-14</b> ( <i>FORKLIFTS</i> ) 4D94LE		Oil Filter Full Flow.....	O-1901	Oil Filter Full Flow.....	C-1122
Air Filter Primary.....	A-8505	<b>FG10</b> ( <i>FORKLIFTS</i> ) J15		<b>FG18-4</b> ( <i>FORKLIFTS</i> ) 4P	
<b>FD30-16</b> ( <i>FORKLIFTS</i> ) 4D94LE		Air Filter Primary.....	AS-2205	Air Filter.....	A-1004
Air Filter Primary.....	A-8505	Oil Filter Full Flow.....	C-1829	Air Filter.....	AS-5412
<b>FD30-17</b> ( <i>FORKLIFTS</i> ) 4D94LE		<b>FG10-8</b> ( <i>FORKLIFTS</i> ) DPU 40DA		Oil Filter Full Flow.....	C-1122
Air Filter Primary.....	A-8505	Oil Filter Full Flow.....	O-1901	<b>FG18D</b> ( <i>FORKLIFTS</i> ) 4P	
<b>FD30T-14</b> ( <i>FORKLIFTS</i> ) 4D94E		<b>FG10ST-15</b> ( <i>FORKLIFTS</i> )		Air Filter.....	AS-5412
Fuel Filter.....	FC-5604	Air Filter Primary.....	AS-2205	Air Filter.....	A-1004
Oil Filter Full Flow.....	C-5606	Oil Filter Full Flow.....	C-1829	Oil Filter Full Flow.....	C-1122
<b>FD30T-16R</b> ( <i>FORKLIFTS</i> ) 4D94LE , 2007		<b>FG14</b> ( <i>FORKLIFTS</i> ) 4P		<b>FG18L</b> ( <i>FORKLIFTS</i> ) 4P	
Fuel Filter.....	FC-5604	Air Filter.....	A-1004	Air Filter.....	AS-5412
Oil Filter Full Flow.....	C-5606	Air Filter.....	AS-5412	Air Filter.....	A-1004
<b>FD40</b> ( <i>FORKLIFTS</i> ) 6D95L		Oil Filter Full Flow.....	C-1122	Oil Filter Full Flow.....	C-1122
Hydraulic Oil Filter.....	HC-7901	<b>FG14</b> ( <i>FORKLIFTS</i> ) D11		<b>FG10 FG SERIES</b> ( <i>FORKLIFTS</i> ) NISSAN J15	
<b>FD40Z</b> ( <i>FORKLIFTS</i> ) 6D95L		Air Filter Primary.....	AS-2205	Oil Filter Full Flow.....	C-1140
Hydraulic Oil Filter.....	HC-7901	Oil Filter Full Flow.....	C-1829	<b>FG20</b> ( <i>FORKLIFTS</i> ) D11	
<b>FD45</b> ( <i>FORKLIFTS</i> ) 6D95L		<b>FG14</b> ( <i>FORKLIFTS</i> ) DPU 40DU		Air Filter Primary.....	AS-2205
Hydraulic Oil Filter.....	HC-7901	Oil Filter Full Flow.....	O-1901	Oil Filter Full Flow.....	C-1829
<b>FD45H</b> ( <i>FORKLIFTS</i> ) 6D95L		<b>FG14</b> ( <i>FORKLIFTS</i> ) J15		<b>FG20</b> ( <i>FORKLIFTS</i> ) H20	
Hydraulic Oil Filter.....	HC-7901	Air Filter Primary.....	AS-2205	Air Filter Primary.....	AS-2205
<b>FD45S</b> ( <i>FORKLIFTS</i> ) 6D95L		Oil Filter Full Flow.....	C-1829	Oil Filter Full Flow.....	C-1829
Hydraulic Oil Filter.....	HC-7901	<b>FG14-6</b> ( <i>FORKLIFTS</i> ) DPU 40DU		<b>FG20</b> ( <i>FORKLIFTS</i> ) H20 (Z SERIES)	
<b>FD40-4</b> ( <i>FORKLIFTS</i> )		Oil Filter Full Flow.....	O-1901	Air Filter Secondary.....	A-7919
Oil Filter Full Flow.....	C-5615	<b>FG15</b> ( <i>FORKLIFTS</i> ) 4P		Air Filter Set.....	AS-5644-S
Oil Filter Full Flow.....	C-5616	Air Filter.....	A-1004	Air Filter Primary.....	AS-5644
<b>FD70H</b> ( <i>FORKLIFTS</i> )		Air Filter.....	AS-5412	<b>FG20</b> ( <i>FORKLIFTS</i> ) J15	
Air Filter Primary.....	AS-5620	Oil Filter Full Flow.....	C-1122	Air Filter Primary.....	AS-2205
Fuel Filter.....	FC-1802	<b>FG15</b> ( <i>FORKLIFTS</i> ) D11		Oil Filter Full Flow.....	C-1829
Hydraulic Oil Filter.....	HC-7901	Air Filter Primary.....	AS-2205	<b>FG20</b> ( <i>FORKLIFTS</i> )	
<b>FD30V-11</b> ( <i>FORKLIFTS</i> )		Oil Filter Full Flow.....	C-1829	Air Filter Set.....	AS-5644-S
Fuel Filter.....	FC-1802	<b>FG15</b> ( <i>FORKLIFTS</i> ) G150		Air Filter Primary.....	AS-5644
Hydraulic Oil Filter.....	HC-7901	Oil Filter Full Flow.....	O-1803	Fuel Filter.....	FC-1802
				<b>FG20</b> ( <i>FORKLIFTS</i> ) NISSAN GS	
				Oil Filter Full Flow.....	O-1901



MODEL/APPLICATION	SAKURA NO	MODEL/APPLICATION	SAKURA NO	MODEL/APPLICATION	SAKURA NO
<b>KOMATSU</b>		<b>KOMATSU</b>		<b>KOMATSU</b>	
<b>FG20-4</b> ( <i>FORKLIFTS</i> ) NISSAN GS		<b>FG25</b> ( <i>FORKLIFTS</i> )		Fuel Filter.....	FC-1802
Oil Filter Full Flow.....	0-1901	Air Filter Primary.....	AS-5644	<b>FG30SHT</b> ( <i>FORKLIFTS</i> )	
<b>FG20-5</b> ( <i>FORKLIFTS</i> ) G201		Air Filter Set.....	AS-5644-S	Air Filter Primary.....	AS-2205
Oil Filter Full Flow.....	0-1803	Fuel Filter.....	FC-1802	Oil Filter Full Flow.....	C-1829
<b>FG20-58</b> ( <i>FORKLIFTS</i> ) G201		<b>FG25-1</b> ( <i>FORKLIFTS</i> ) G201		<b>FG33</b> ( <i>FORKLIFTS</i> ) P40	
Oil Filter Full Flow.....	0-1803	Oil Filter Full Flow.....	0-1803	Air Filter Primary.....	AS-1014
<b>FG20S</b> ( <i>FORKLIFTS</i> ) C-175		<b>FG25L</b> ( <i>FORKLIFTS</i> ) J15		Hydraulic Oil Filter.....	HC-7901
Oil Filter Full Flow.....	0-1901	Air Filter Primary.....	AS-2205	Oil Filter Full Flow.....	C-1803
<b>FG20S</b> ( <i>FORKLIFTS</i> ) DL201		<b>FG25S</b> ( <i>FORKLIFTS</i> )		Oil Filter Full Flow.....	C-1834
Oil Filter Full Flow.....	0-1901	Air Filter Set.....	AS-5644-S	<b>FG33N</b> ( <i>FORKLIFTS</i> ) P40	
<b>FG20S</b> ( <i>FORKLIFTS</i> ) G201		Air Filter Primary.....	AS-5644	Air Filter Primary.....	AS-1014
Oil Filter Full Flow.....	0-1803	Fuel Filter.....	FC-1802	Hydraulic Oil Filter.....	HC-7901
<b>FG20S</b> ( <i>FORKLIFTS</i> )		<b>FG25T-12</b> ( <i>FORKLIFTS</i> ) 37Z-02-0F201L		Oil Filter Full Flow.....	C-1834
Air Filter Set.....	AS-5644-S	Air Filter Primary.....	AS-2205	Oil Filter Full Flow.....	C-1803
Air Filter Primary.....	AS-5644	Hydraulic Oil Filter Transmission...	HC-1119	Oil Filter Full Flow.....	C-1803
Fuel Filter.....	FC-1802	<b>FG28</b> ( <i>FORKLIFTS</i> ) H20		<b>FG35</b> ( <i>FORKLIFTS</i> ) P40	
<b>FG20ST-04</b> ( <i>FORKLIFTS</i> )		Air Filter Primary.....	AS-2205	Air Filter Primary.....	AS-1014
Air Filter Primary.....	AS-2205	Oil Filter Full Flow.....	C-1829	Hydraulic Oil Filter.....	HC-7901
Oil Filter Full Flow.....	C-1829	<b>FG30</b> ( <i>FORKLIFTS</i> ) H20		Oil Filter Full Flow.....	C-1803
<b>FG23</b> ( <i>FORKLIFTS</i> ) H20		Air Filter Primary.....	AS-2205	Oil Filter Full Flow.....	C-1834
Air Filter Primary.....	AS-2205	<b>FG30</b> ( <i>FORKLIFTS</i> ) H20 (Z SERIES)		<b>FG40</b> ( <i>FORKLIFTS</i> ) P40	
Oil Filter Full Flow.....	C-1829	Air Filter Secondary.....	A-7919	Air Filter Primary.....	AS-1014
<b>FG25</b> ( <i>FORKLIFTS</i> ) D11		Air Filter Set.....	AS-5644-S	Hydraulic Oil Filter.....	HC-7901
Air Filter Primary.....	AS-2205	Air Filter Primary.....	AS-5644	Oil Filter Full Flow.....	C-1834
Oil Filter Full Flow.....	C-1829	<b>FG30-11</b> ( <i>FORKLIFTS</i> ) H20 (Z SERIES)		Oil Filter Full Flow.....	C-1803
<b>FG25</b> ( <i>FORKLIFTS</i> ) G150		Air Filter Secondary.....	A-7919	<b>FG45</b> ( <i>FORKLIFTS</i> ) P40	
Oil Filter Full Flow.....	0-1803	Air Filter Set.....	AS-5644-S	Air Filter Primary.....	AS-1014
<b>FG25</b> ( <i>FORKLIFTS</i> ) G207		Air Filter Primary.....	AS-5644	Hydraulic Oil Filter.....	HC-7901
Oil Filter Full Flow.....	0-1803	<b>FG30-11</b> ( <i>FORKLIFTS</i> )		Oil Filter Full Flow.....	C-1834
<b>FG25</b> ( <i>FORKLIFTS</i> ) H20		Air Filter Set.....	AS-5644-S	Oil Filter Full Flow.....	C-1803
Air Filter Primary.....	AS-2205	Air Filter Primary.....	AS-5644	<b>FG45-4</b> ( <i>FORKLIFTS</i> ) P40	
Oil Filter Full Flow.....	C-1829	Fuel Filter.....	FC-1802	Air Filter Primary.....	AS-1014
<b>FG25</b> ( <i>FORKLIFTS</i> ) H20 (Z SERIES)		<b>FG30-4</b> ( <i>FORKLIFTS</i> ) H20		Hydraulic Oil Filter.....	HC-7901
Air Filter Primary.....	AS-5644	Air Filter Primary.....	AS-2205	Oil Filter Full Flow.....	C-1803
Air Filter Secondary.....	A-7919	Oil Filter Full Flow.....	C-1829	Oil Filter Full Flow.....	C-1834
Air Filter Set.....	AS-5644-S	<b>FG30S</b> ( <i>FORKLIFTS</i> ) H20		<b>FG45S</b> ( <i>FORKLIFTS</i> ) P40	
<b>FG25</b> ( <i>FORKLIFTS</i> ) J15		Air Filter Primary.....	AS-2205	Air Filter Primary.....	AS-1014
Air Filter Primary.....	AS-2205	Oil Filter Full Flow.....	C-1829	Hydraulic Oil Filter.....	HC-7901
Oil Filter Full Flow.....	C-1829	<b>FG30S</b> ( <i>FORKLIFTS</i> ) H20		Oil Filter Full Flow.....	C-1803
<b>FG30S-11</b> ( <i>FORKLIFTS</i> )		Air Filter Primary.....	AS-2205	Oil Filter Full Flow.....	C-1834
Air Filter Set.....	AS-5644-S	Oil Filter Full Flow.....	C-1829	<b>FU135D</b> ( <i>DOZERS</i> )	
Air Filter Primary.....	AS-5644	<b>FG30S-11</b> ( <i>FORKLIFTS</i> )		Fuel Filter.....	FC-5103
Air Filter Primary.....	AS-5644	Air Filter Set.....	AS-5644-S		
		Air Filter Primary.....	AS-5644		

MODEL/APPLICATION	SAKURA NO	MODEL/APPLICATION	SAKURA NO	MODEL/APPLICATION	SAKURA NO
<b>KOMATSU</b>		<b>KOMATSU</b>		<b>KOMATSU</b>	
<b>FU237D</b> (DOZERS)		<b>GD300A-1</b> (MOTOR GRADERS) 4D150-5/2001		Fuel Filter.....	F-5601
Fuel Filter.....	FC-5103	Air Filter Primary.....	AS-7805	Hydraulic Oil Filter.....	H-5608
<b>FUD136</b> (DOZERS)		Air Filter Secondary.....	A-7806	Oil Filter Full Flow.....	O-5603
Fuel Filter.....	FC-5103	Fuel Filter.....	FC-5604	Oil Filter By Pass.....	O-5704
<b>FUD136M</b> (DOZERS)		Hydraulic Oil Filter.....	H-5611		
Fuel Filter.....	FC-5103	Oil Filter Full Flow.....	C-5614	<b>GD40-2</b> (MOTOR GRADERS) NH220	
<b>FV267D</b> (DOZERS)				Air Filter Primary.....	A-5623
Fuel Filter.....	FC-5103	<b>GD305A-1A</b> (MOTOR GRADERS) 6D95L-1/6734		Air Filter Set.....	A-5622-S
<b>FVV237D</b> (DOZERS)		Air Filter Primary.....	AS-7805	Air Filter Secondary.....	A-5624
Fuel Filter.....	FC-5103	Air Filter Secondary.....	A-7806	Coolant Filter.....	WC-5711
<b>FVV240</b> (DOZERS)		Fuel Filter.....	FC-5604	Fuel Filter.....	F-5601
Fuel Filter.....	FC-5103	<b>GD30-5M</b> (MOTOR GRADERS) 4D105-5		Hydraulic Oil Filter.....	H-5611
<b>FVV267D</b> (DOZERS)		Air Filter Set.....	A-5657-S	Oil Filter Full Flow.....	O-5603
Fuel Filter.....	FC-5103	Air Filter Primary.....	A-5649	Oil Filter By Pass.....	O-5704
<b>FVV270</b> (DOZERS)		Fuel Filter.....	F-2626		
Fuel Filter.....	FC-5103	Oil Filter Full Flow.....	O-5601	<b>GD405A-1</b> (MOTOR GRADERS) 6D105-1/50002	
<b>GD200A-1</b> (MOTOR GRADERS) 4D150-5/2001		<b>GD313A-1</b> (MOTOR GRADERS) 6D95L		Air Filter Secondary.....	A-6009
Air Filter Secondary.....	A-7806	Oil Filter Full Flow.....	C-5615	Air Filter Primary.....	AS-1024
Air Filter Primary.....	AS-7805	Oil Filter Full Flow.....	C-5616	Air Filter Set.....	AS-1024-S
Fuel Filter.....	FC-5604			Hydraulic Oil Filter.....	H-5608
Hydraulic Oil Filter.....	H-5611	<b>GD313A-1</b> (MOTOR GRADERS) 6D95L-1/30001		Hydraulic Oil Filter.....	H-5620
Oil Filter Full Flow.....	C-5614	Air Filter Primary.....	AS-7805	Oil Filter Full Flow.....	C-5614
<b>GD22-1</b> (MOTOR GRADERS) 4D92		Air Filter Secondary.....	A-7806		
Air Filter Primary.....	A-5616	Fuel Filter.....	FC-5604	<b>GD461A-1</b> (MOTOR GRADERS) S6D95L	
Air Filter Set.....	A-5655-S	Hydraulic Oil Filter.....	H-5625	Oil Filter Full Flow.....	C-5615
Air Filter Secondary.....	A-5617	Oil Filter Full Flow.....	C-5604	Oil Filter Full Flow.....	C-5616
Hydraulic Oil Filter.....	H-5611			<b>GD461A-1</b> (MOTOR GRADERS) S6D95L-1/10001	
<b>GD22AC-1</b> (MOTOR GRADERS) 4D105-1		<b>GD31-3H</b> (MOTOR GRADERS) S4D120		Air Filter Secondary.....	A-5635
Air Filter Primary.....	A-5616	Air Filter Set.....	A-5604-S	Air Filter Primary.....	A-5639
Air Filter Set.....	A-5655-S	Air Filter Secondary.....	A-5606	Fuel Filter.....	FC-5604
Air Filter Secondary.....	A-5617	Air Filter Primary.....	A-5605	Hydraulic Oil Filter.....	H-5625
Fuel Filter.....	FC-5605	Fuel Filter.....	F-2626	Hydraulic Oil Filter.....	H-5620
Hydraulic Oil Filter.....	H-5611	Hydraulic Oil Filter.....	H-5608	Oil Filter Full Flow.....	C-5604
Oil Filter Full Flow.....	C-6202	Oil Filter Full Flow.....	O-5601		
Oil Filter Full Flow.....	C-5606	<b>GD31RC-3A</b> (MOTOR GRADERS) 4D130		<b>GD500R-1</b> (MOTOR GRADERS) S4D130-1/10001	
<b>GD28AC-1</b> (MOTOR GRADERS) 4D105-1		Air Filter Primary.....	A-5602	Air Filter Primary.....	A-5605
Air Filter Secondary.....	A-5617	Air Filter Secondary.....	A-5603	Air Filter Secondary.....	A-5606
Air Filter Set.....	A-5655-S	Coolant Filter.....	WC-5707	Air Filter Set.....	A-5604-S
Air Filter Primary.....	A-5616	Fuel Filter.....	F-2626	Fuel Filter.....	F-2626
Fuel Filter.....	FC-5605	Hydraulic Oil Filter.....	H-5608	Hydraulic Oil Filter.....	H-5608
Hydraulic Oil Filter.....	H-5611			Oil Filter By Pass.....	O-5704
Oil Filter Full Flow.....	C-6202	<b>GD37-5H</b> (MOTOR GRADERS) S4D120		Oil Filter Full Flow.....	O-5601
Oil Filter Full Flow.....	C-5606	Air Filter Secondary.....	A-5606		
<b>GD28AC-1</b> (MOTOR GRADERS) 4D105-1		Air Filter Primary.....	A-5605	<b>GD500R-1</b> (MOTOR GRADERS) SYD130-1	
Air Filter Secondary.....	A-5617	Air Filter Set.....	A-5604-S	Air Filter Primary.....	A-5605
Air Filter Set.....	A-5655-S	Fuel Filter.....	F-2626	Air Filter Secondary.....	A-5606
Air Filter Primary.....	A-5616	Hydraulic Oil Filter.....	H-5608	Air Filter Set.....	A-5604-S
Fuel Filter.....	FC-5605	Oil Filter Full Flow.....	O-5601	Coolant Filter.....	WC-5707
Hydraulic Oil Filter.....	H-5611			Fuel Filter.....	F-2626
Oil Filter Full Flow.....	C-6202	<b>GD37-6H</b> (MOTOR GRADERS) NH220		Hydraulic Oil Filter.....	H-5608
Oil Filter Full Flow.....	C-5606	Air Filter Primary.....	A-5637	Oil Filter By Pass.....	O-5704
		Air Filter Primary.....	A-5636	Oil Filter Full Flow.....	O-5601
		Coolant Filter.....	WC-5711		
				<b>GD500R-2</b> (MOTOR GRADERS) NH220	
				Air Filter Set.....	A-5604-S
				Air Filter Primary.....	A-5605
				Air Filter Secondary.....	A-5606

MODEL/APPLICATION	SAKURA NO	MODEL/APPLICATION	SAKURA NO	MODEL/APPLICATION	SAKURA NO
<b>KOMATSU</b>		<b>KOMATSU</b>		<b>KOMATSU</b>	
<b>GD500R-2</b> (MOTOR GRADERS) NH220		Oil Filter Full Flow.....	C-5615	Air Filter Primary.....	A-5605
Coolant Filter.....	WC-5711	Oil Filter Full Flow.....	C-5616	Hydraulic Oil Filter.....	H-5607
Hydraulic Oil Filter.....	H-5608	<b>GD510R-2</b> (MOTOR GRADERS) S6D95L-1/15001		Oil Filter Full Flow.....	C-5614
Oil Filter Full Flow.....	O-5603	Air Filter Secondary.....	A-5635	<b>GD523A-1</b> (MOTOR GRADERS)	
Oil Filter By Pass.....	O-5704	Air Filter Primary.....	A-5639	Air Filter Primary.....	A-5605
<b>GD500R-2</b> (MOTOR GRADERS) S6D105-1/11002		Fuel Filter.....	FC-5604	Air Filter Set.....	A-5604-S
Air Filter Set.....	A-5604-S	Hydraulic Oil Filter.....	H-5607	Air Filter Secondary.....	A-5606
Air Filter Primary.....	A-5605	Oil Filter Full Flow.....	C-5604	Hydraulic Oil Filter.....	H-5620
Air Filter Secondary.....	A-5606	<b>GD511A-1</b> (MOTOR GRADERS) S6D95L-1/10001		Hydraulic Oil Filter.....	H-5607
Coolant Filter.....	WC-5712	Air Filter Secondary.....	A-5635	Oil Filter Full Flow.....	C-5614
Hydraulic Oil Filter.....	H-5608	Air Filter Primary.....	A-5639	<b>GD523A-1</b> (MOTOR GRADERS) S6D105-1/30001	
Hydraulic Oil Filter.....	H-5620	Fuel Filter.....	FC-5604	Air Filter Primary.....	A-5605
Oil Filter Full Flow.....	C-5614	Hydraulic Oil Filter.....	H-5607	Air Filter Set.....	A-5604-S
<b>GD500R-5</b> (MOTOR GRADERS) S/N: 11002		Oil Filter Full Flow.....	C-5604	Air Filter Secondary.....	A-5606
Air Filter Set.....	A-5604-S	<b>GD511R-1</b> (MOTOR GRADERS) S6D95L-1/10001		Hydraulic Oil Filter.....	H-5607
Air Filter Secondary.....	A-5606	Air Filter Secondary.....	A-5635	Oil Filter Full Flow.....	C-5614
Air Filter Primary.....	A-5605	Air Filter Primary.....	A-5639	<b>GD523R-1</b> (MOTOR GRADERS) S6D105-1/30001	
Hydraulic Oil Filter.....	H-5608	Fuel Filter.....	FC-5604	Air Filter Primary.....	A-5605
Hydraulic Oil Filter.....	H-5620	Hydraulic Oil Filter.....	H-5607	Air Filter Secondary.....	A-5606
Oil Filter Full Flow.....	C-5614	Oil Filter Full Flow.....	C-5604	Air Filter Set.....	A-5604-S
<b>GD505A-2</b> (MOTOR GRADERS) S6D105-1/50002		<b>GD513A-1</b> (MOTOR GRADERS)		Hydraulic Oil Filter.....	H-5607
Air Filter Set.....	A-5604-S	Air Filter Secondary.....	A-5635	Oil Filter Full Flow.....	C-5614
Air Filter Secondary.....	A-5606	Air Filter Primary.....	A-5639	<b>GD525A-1</b> (MOTOR GRADERS) S6D105-1/50001	
Air Filter Primary.....	A-5605	Fuel Filter.....	FC-5604	Air Filter Primary.....	A-5605
Coolant Filter.....	WC-5712	Hydraulic Oil Filter.....	H-5607	Air Filter Set.....	A-5604-S
Hydraulic Oil Filter.....	H-5620	Hydraulic Oil Filter.....	H-5620	Air Filter Secondary.....	A-5606
Hydraulic Oil Filter.....	H-5608	Oil Filter Full Flow.....	C-5604	Hydraulic Oil Filter.....	H-5607
Oil Filter Full Flow.....	C-5614	<b>GD515A-1</b> (MOTOR GRADERS)		Oil Filter Full Flow.....	C-5614
<b>GD505R-2</b> (MOTOR GRADERS) S6D105-1		Air Filter Secondary.....	A-5635	<b>GD525A-1</b> (MOTOR GRADERS) S/N: 50001	
Air Filter Set.....	A-5604-S	Air Filter Primary.....	A-5639	Air Filter Primary.....	A-5605
Air Filter Secondary.....	A-5606	Hydraulic Oil Filter.....	H-5607	Air Filter Set.....	A-5604-S
Air Filter Primary.....	A-5605	Hydraulic Oil Filter.....	H-5620	Air Filter Secondary.....	A-5606
Coolant Filter.....	WC-5707	Oil Filter Full Flow.....	C-5608	Hydraulic Oil Filter.....	H-5607
Hydraulic Oil Filter.....	H-5608	<b>GD521A-1</b> (MOTOR GRADERS)		Hydraulic Oil Filter.....	H-5620
Hydraulic Oil Filter.....	H-5620	Air Filter Set.....	A-5604-S	Oil Filter Full Flow.....	C-5614
Oil Filter Full Flow.....	C-5614	Air Filter Secondary.....	A-5606	<b>GD530</b> (MOTOR GRADERS)	
<b>GD505R-2</b> (MOTOR GRADERS) S6D105-1/30002		Air Filter Primary.....	A-5605	Fuel Filter Secondary.....	FC-7903
Air Filter Set.....	A-5604-S	Hydraulic Oil Filter.....	H-5607	Fuel/Water Separator.....	SFC-5706
Air Filter Secondary.....	A-5606	Hydraulic Oil Filter.....	H-5620	Fuel/Water Separator.....	SFC-5708
Air Filter Primary.....	A-5605	Oil Filter Full Flow.....	C-5614	Hydraulic Oil Filter.....	HC-76080
Coolant Filter.....	WC-5712	<b>GD521A-1</b> (MOTOR GRADERS) S6D105-1/10001		Oil Filter Full Flow.....	C-5730
Hydraulic Oil Filter.....	H-5608	Air Filter Primary.....	A-5605	<b>GD530-2A</b> (MOTOR GRADERS)	
Hydraulic Oil Filter.....	H-5620	Air Filter Set.....	A-5604-S	Air Filter Secondary.....	A-8522
Oil Filter Full Flow.....	C-5614	Air Filter Secondary.....	A-5606	Air Filter Set.....	A-8521-S
<b>GD510R-1</b> (MOTOR GRADERS) S/N: 15001		Hydraulic Oil Filter.....	H-5607	Air Filter Primary.....	A-8521
Air Filter Secondary.....	A-5635	Oil Filter Full Flow.....	C-5614	Coolant Filter.....	WC-5706
Air Filter Primary.....	A-5639	<b>GD521R-1</b> (MOTOR GRADERS) S6D105-1/10001		Fuel Filter Secondary.....	FC-7903
Fuel Filter.....	FC-5604	Air Filter Set.....	A-5604-S	Fuel/Water Separator.....	SFC-5708
Hydraulic Oil Filter.....	H-5607	Air Filter Secondary.....	A-5606	Fuel/Water Separator.....	SFC-5706
Oil Filter Full Flow.....	C-5604	Hydraulic Oil Filter.....	H-5607	Hydraulic Oil Filter.....	HC-76080
<b>GD510R-2</b> (MOTOR GRADERS) S6D95L		Oil Filter Full Flow.....	C-5614	Oil Filter Full Flow.....	HC-5508
Air Filter Set.....	A-5604-S	<b>GD521R-1</b> (MOTOR GRADERS) S6D105-1/10001		<b>GD530-2A</b> (MOTOR GRADERS)	
Air Filter Secondary.....	A-5606	Air Filter Primary.....	A-5605	Air Filter Secondary.....	A-8522

MODEL/APPLICATION	SAKURA NO	MODEL/APPLICATION	SAKURA NO	MODEL/APPLICATION	SAKURA NO
<b>KOMATSU</b>		<b>KOMATSU</b>		<b>KOMATSU</b>	
<b>GD530-2A</b> (MOTOR GRADERS)		Air Filter Primary.....	A-8577	Air Filter Primary.....	A-5605
Oil Filter Full Flow.....	C-5730	Air Filter Secondary.....	A-8578	Air Filter Set.....	A-5604-S
<b>GD530-2B</b> (MOTOR GRADERS)		Cabin Air Filter.....	CA-56041	Air Filter Secondary.....	A-5606
Air Filter Set.....	A-8521-S	Fuel/Water Separator.....	SFC-5706	Fuel Filter.....	FC-5602
Air Filter Primary.....	A-8521	Hydraulic Oil Filter.....	H-56600	Hydraulic Oil Filter.....	H-5620
Air Filter Secondary.....	A-8522	<b>GD555-3C</b> (MOTOR GRADERS)		Oil Filter Full Flow.....	C-5614
Coolant Filter.....	WC-5706	<b>SA6D102E</b>		<b>GD605</b> (MOTOR GRADERS)	
Fuel Filter Secondary.....	FC-7903	Air Filter Secondary.....	A-8578	Air Filter Set.....	A-5604-S
Fuel/Water Separator.....	SFC-5708	Air Filter Primary.....	A-8577	Air Filter Secondary.....	A-5606
Fuel/Water Separator.....	SFC-5706	Cabin Air Filter.....	CA-56041	Air Filter Primary.....	A-5605
Hydraulic Oil Filter.....	HC-5508	Fuel/Water Separator.....	SFC-5706	Fuel Filter.....	FC-5602
Hydraulic Oil Filter.....	HC-5508	Hydraulic Oil Filter.....	H-56600	Hydraulic Oil Filter.....	H-5620
Hydraulic Oil Filter.....	HC-76080	<b>GD555-3C</b> (MOTOR GRADERS)		Oil Filter Full Flow.....	C-5614
Oil Filter Full Flow.....	C-5730	<b>SA6D102E</b>		<b>GD605A-1</b> (MOTOR GRADERS)	
<b>GD530-2C</b> (MOTOR GRADERS)		Air Filter Secondary.....	A-8578	<b>NH220</b>	
Air Filter Primary.....	A-8521	Air Filter Primary.....	A-8577	Air Filter Primary.....	A-5605
Air Filter Set.....	A-8521-S	Cabin Air Filter.....	CA-56041	Air Filter Set.....	A-5604-S
Air Filter Secondary.....	A-8522	Fuel/Water Separator.....	SFC-5706	Air Filter Secondary.....	A-5606
Coolant Filter.....	WC-5706	Hydraulic Oil Filter.....	H-56600	Coolant Filter.....	WC-5711
Fuel Filter Secondary.....	FC-7903	<b>GD525A-1C</b> (MOTOR GRADERS)		Hydraulic Oil Filter.....	H-5620
Fuel/Water Separator.....	SFC-5708	Cabin Air Filter.....	CA-56150	Oil Filter Full Flow.....	O-5603
Fuel/Water Separator.....	SFC-5706	<b>GD600R</b> (MOTOR GRADERS)		Oil Filter By Pass.....	O-5704
Hydraulic Oil Filter.....	HC-5508	Air Filter Primary.....	A-5605	<b>GD605A-1</b> (MOTOR GRADERS)	
Hydraulic Oil Filter.....	HC-76080	Air Filter Secondary.....	A-5606	<b>NH220/50002</b>	
Oil Filter Full Flow.....	C-5730	Air Filter Set.....	A-5604-S	Air Filter Primary.....	A-5605
<b>GD530A-1</b> (MOTOR GRADERS)		Fuel Filter.....	FC-5602	Air Filter Set.....	A-5604-S
<b>CUMMINS DIESEL</b>		Hydraulic Oil Filter.....	H-5620	Air Filter Secondary.....	A-5606
Air Filter Set.....	A-8521-S	Oil Filter Full Flow.....	C-5614	Fuel Filter.....	F-5601
Air Filter Primary.....	A-8521	<b>GD600R-1</b> (MOTOR GRADERS)		Hydraulic Oil Filter.....	H-5620
Air Filter Secondary.....	A-8522	<b>NH220/10002</b>		Hydraulic Oil Filter.....	H-5608
Fuel Filter Secondary.....	FC-7903	Air Filter Set.....	A-5604-S	Oil Filter Full Flow.....	O-5603
Fuel/Water Separator.....	SFC-5708	Air Filter Primary.....	A-5605	Oil Filter By Pass.....	O-5704
Fuel/Water Separator.....	SFC-5706	Air Filter Secondary.....	A-5606	<b>GD605A-2</b> (MOTOR GRADERS)	
Hydraulic Oil Filter.....	HC-5508	Fuel Filter.....	F-5601	<b>CUMMINS NH220</b>	
Hydraulic Oil Filter.....	HC-76080	Hydraulic Oil Filter.....	H-5608	Fuel Filter.....	FC-5606
Oil Filter Full Flow.....	C-5730	Hydraulic Oil Filter.....	H-5608	<b>GD605A-2</b> (MOTOR GRADERS)	
<b>GD530A-2</b> (MOTOR GRADERS)		Oil Filter Full Flow.....	O-5603	<b>NH220/53001</b>	
<b>CUMMINS DIESEL</b>		<b>GD600R-2</b> (MOTOR GRADERS)		Air Filter Primary.....	A-5605
Air Filter Set.....	A-8521-S	<b>NH220</b>		Air Filter Secondary.....	A-5606
Air Filter Primary.....	A-8521	Fuel Filter.....	FC-5606	Air Filter Set.....	A-5604-S
Air Filter Secondary.....	A-8522	<b>GD600R-2</b> (MOTOR GRADERS)		Fuel Filter.....	FC-5602
Fuel Filter Secondary.....	FC-7903	<b>NH220/13001</b>		Hydraulic Oil Filter.....	H-5620
Fuel/Water Separator.....	SFC-5708	Air Filter Set.....	A-5604-S	Oil Filter Full Flow.....	C-5701
Fuel/Water Separator.....	SFC-5706	Air Filter Primary.....	A-5605	Oil Filter Full Flow.....	C-5605
Hydraulic Oil Filter.....	HC-5508	Air Filter Secondary.....	A-5606	Oil Filter Full Flow.....	C-5715
Hydraulic Oil Filter.....	HC-76080	Air Filter Primary.....	A-5605	Oil Filter By Pass.....	O-5704
Oil Filter Full Flow.....	C-5730	Fuel Filter.....	FC-5602	<b>GD605A-3</b> (MOTOR GRADERS)	
<b>GD555-3</b> (MOTOR GRADERS)		Hydraulic Oil Filter.....	H-5620	<b>6D125-1</b>	
<b>SA6D102E</b>		Oil Filter By Pass.....	O-5704	Fuel Filter.....	FC-5606
Air Filter Secondary.....	A-8578	Oil Filter Full Flow.....	C-5701	<b>GD605A-3</b> (MOTOR GRADERS)	
Air Filter Primary.....	A-8577	Oil Filter Full Flow.....	C-5715	<b>6D125-1/54001</b>	
Cabin Air Filter.....	CA-56041	Oil Filter Full Flow.....	C-5605	Air Filter Set.....	A-5604-S
Fuel/Water Separator.....	SFC-5706	<b>GD600R-3</b> (MOTOR GRADERS)		Air Filter Secondary.....	A-5606
Hydraulic Oil Filter.....	H-56600	<b>6D125-1</b>		Air Filter Primary.....	A-5605
<b>GD555-3</b> (MOTOR GRADERS)		Fuel Filter.....	FC-5606	Fuel Filter.....	FC-5602
<b>SA6D102E</b>		<b>GD600R-3</b> (MOTOR GRADERS)		Hydraulic Oil Filter.....	H-5620
Air Filter Secondary.....	A-8578	<b>6D125-1/14001</b>		Oil Filter Full Flow.....	C-5614

# Sakura Filter

# ENGINE APPLICATION

MODEL/APPLICATION	SAKURA NO	MODEL/APPLICATION	SAKURA NO	MODEL/APPLICATION	SAKURA NO
<b>KOMATSU</b>		<b>KOMATSU</b>		<b>KOMATSU</b>	
<b>GD605R-1</b> (MOTOR GRADERS) NH220/30002		Air Filter Secondary.....	A-5635	Hydraulic Oil Filter.....	H-5620
Air Filter Set.....	A-5604-S	Air Filter Set.....	A-5604-S	Oil Filter Full Flow.....	C-5614
Air Filter Secondary.....	A-5606	Air Filter Primary.....	A-5605	<b>GD625A-1</b> (MOTOR GRADERS)	
Air Filter Primary.....	A-5605	Air Filter Secondary.....	A-5606	Cabin Air Filter.....	CA-56150
Fuel Filter.....	F-5601	Air Filter Primary.....	A-5639	<b>GD650-1</b> (MOTOR GRADERS) S6D114	
Hydraulic Oil Filter.....	H-5620	Hydraulic Oil Filter.....	H-5607	Air Filter Set.....	A-8521-S
Hydraulic Oil Filter.....	H-5608	Oil Filter Full Flow.....	C-5608	Air Filter Primary.....	A-8521
Oil Filter Full Flow.....	O-5603	Oil Filter Full Flow.....	C-5614	Air Filter Secondary.....	A-8522
Oil Filter By Pass.....	O-5704	<b>GD615A-1</b> (MOTOR GRADERS) S6D110-1		Coolant Filter.....	WC-5705
<b>GD605R-2</b> (MOTOR GRADERS) CUMMINS NH220		Air Filter Secondary.....	A-5635	Fuel Filter Secondary.....	FC-7903
Fuel Filter.....	FC-5606	Air Filter Primary.....	A-5639	Fuel/Water Separator.....	SFC-5708
<b>GD605R-2</b> (MOTOR GRADERS) NH220/33001		Coolant Filter.....	WC-5707	Fuel/Water Separator.....	SFC-5706
Air Filter Primary.....	A-5605	Hydraulic Oil Filter.....	H-5620	Hydraulic Oil Filter.....	HC-76080
Air Filter Set.....	A-5604-S	Hydraulic Oil Filter.....	H-5607	Hydraulic Oil Filter.....	HC-5508
Air Filter Secondary.....	A-5606	Oil Filter Full Flow.....	C-5608	Oil Filter Combination.....	C-5723
Fuel Filter.....	FC-5602	<b>GD621A-1</b> (MOTOR GRADERS) S6D105-1/10001		<b>GD650-2A</b> (MOTOR GRADERS)	
Hydraulic Oil Filter.....	H-5620	Air Filter Secondary.....	A-5635	Air Filter Set.....	A-8521-S
Oil Filter Full Flow.....	C-5701	Air Filter Secondary.....	A-5606	Air Filter Primary.....	A-8521
Oil Filter Full Flow.....	C-5715	Air Filter Primary.....	A-5605	Air Filter Secondary.....	A-8522
Oil Filter By Pass.....	O-5704	Air Filter Primary.....	A-5639	Coolant Filter.....	WC-5706
Oil Filter Full Flow.....	C-5605	Air Filter Set.....	A-5604-S	Fuel Filter Secondary.....	FC-7903
<b>GD605R-3</b> (MOTOR GRADERS) 6D125-1		Hydraulic Oil Filter.....	H-5607	Fuel/Water Separator.....	SFC-5706
Fuel Filter.....	FC-5606	Oil Filter Full Flow.....	C-5608	Fuel/Water Separator.....	SFC-5708
<b>GD605R-3</b> (MOTOR GRADERS) 6D125-1/34001		Oil Filter Full Flow.....	C-5614	Hydraulic Oil Filter.....	HC-76080
Air Filter Set.....	A-5604-S	<b>GD621R-1</b> (MOTOR GRADERS) S6D105-1/10001		Hydraulic Oil Filter.....	HC-5508
Air Filter Secondary.....	A-5606	Air Filter Secondary.....	A-5635	Oil Filter Combination.....	C-5723
Air Filter Primary.....	A-5605	Air Filter Set.....	A-5604-S	<b>GD650-2B</b> (MOTOR GRADERS)	
Fuel Filter.....	FC-5602	Air Filter Primary.....	A-5605	Air Filter Primary.....	A-8521
Hydraulic Oil Filter.....	H-5620	Air Filter Secondary.....	A-5606	Air Filter Secondary.....	A-8522
Oil Filter Full Flow.....	C-5614	Air Filter Primary.....	A-5639	Air Filter Set.....	A-8521-S
<b>GD611A-1</b> (MOTOR GRADERS) S6D105-1/10001		Hydraulic Oil Filter.....	H-5607	Coolant Filter.....	WC-5706
Air Filter Set.....	A-5604-S	Oil Filter Full Flow.....	C-5614	Fuel Filter Secondary.....	FC-7903
Air Filter Secondary.....	A-5606	<b>GD623R-1</b> (MOTOR GRADERS) S6D105-1/30001		Fuel/Water Separator.....	SFC-5708
Air Filter Primary.....	A-5605	Air Filter Secondary.....	A-5606	Fuel/Water Separator.....	SFC-5706
Fuel Filter.....	FC-5602	Air Filter Primary.....	A-5605	Hydraulic Oil Filter.....	HC-76080
Hydraulic Oil Filter.....	H-5620	Air Filter Primary.....	A-5639	Hydraulic Oil Filter.....	HC-5508
Oil Filter Full Flow.....	C-5614	Air Filter Set.....	A-5604-S	Oil Filter Combination.....	C-5723
<b>GD613A-1</b> (MOTOR GRADERS) 6D125-1/30001		Air Filter Secondary.....	A-5635	<b>GD650A-2</b> (MOTOR GRADERS) S6D114	
Air Filter Secondary.....	A-5603	Hydraulic Oil Filter.....	H-5607	Air Filter Secondary.....	A-8522
Air Filter Primary.....	A-5605	Oil Filter Full Flow.....	C-5614	Air Filter Set.....	A-8521-S
Air Filter Set.....	A-5604-S	Oil Filter Full Flow.....	C-5608	Air Filter Primary.....	A-8521
Air Filter Primary.....	A-5602	<b>GD625A-1</b> (MOTOR GRADERS) 6D125		Coolant Filter.....	WC-5705
Air Filter Secondary.....	A-5606	Fuel Filter.....	FC-5606	Fuel Filter Secondary.....	FC-7903
Fuel Filter.....	FC-5602	<b>GD625A-1</b> (MOTOR GRADERS) 6D125-1/50001		Fuel/Water Separator.....	SFC-5708
Hydraulic Oil Filter.....	H-5607	Air Filter Set.....	A-5604-S	Fuel/Water Separator.....	SFC-5706
Oil Filter Full Flow.....	C-5614	Air Filter Primary.....	A-5602	Hydraulic Oil Filter.....	HC-5508
<b>GD613R-1</b> (MOTOR GRADERS) S6D105-1/30001		Air Filter Secondary.....	A-5606	Hydraulic Oil Filter.....	HC-76080
Air Filter Secondary.....	A-5603	Air Filter Secondary.....	A-5603	Oil Filter Combination.....	C-5723
Air Filter Primary.....	A-5605	Air Filter Secondary.....	A-5606	<b>GD650A-2B</b> (MOTOR GRADERS) S6D114E/202487	
Air Filter Set.....	A-5604-S	Air Filter Primary.....	A-5602	Air Filter Primary.....	A-8521
Air Filter Primary.....	A-5602	Fuel Filter.....	FC-5602	Air Filter Set.....	A-8521-S
Air Filter Secondary.....	A-5606	Hydraulic Oil Filter.....	H-5607	Air Filter Secondary.....	A-8522

MODEL/APPLICATION	SAKURA NO	MODEL/APPLICATION	SAKURA NO	MODEL/APPLICATION	SAKURA NO
<b>KOMATSU</b>		<b>KOMATSU</b>		<b>KOMATSU</b>	
<b>GD650A-2B</b> (MOTOR GRADERS) S6D114E/202487		Air Filter Secondary.....	A-5606	Air Filter Primary.....	A-5605
Coolant Filter.....	WC-5705	Air Filter Set.....	A-5604-S	Fuel Filter.....	F-5601
Fuel Filter Secondary.....	FC-7903	Air Filter Primary.....	A-5605	Hydraulic Oil Filter.....	H-5620
Fuel/Water Separator.....	SFC-5706	Fuel Filter.....	FC-5602	Hydraulic Oil Filter.....	H-5608
Fuel/Water Separator.....	SFC-5708	Hydraulic Oil Filter.....	H-5620	Oil Filter Full Flow.....	O-5603
Hydraulic Oil Filter.....	HC-5508	Oil Filter Full Flow.....	C-5715	Oil Filter By Pass.....	O-5704
Hydraulic Oil Filter.....	HC-76080	Oil Filter Full Flow.....	C-5605		
Oil Filter Combination.....	C-5723	Oil Filter Full Flow.....	C-5701	<b>GD655A-2</b> (MOTOR GRADERS) CUMMINS NH220	
		Oil Filter By Pass.....	O-5704	Fuel Filter.....	FC-5606
<b>GD650A-2C</b> (MOTOR GRADERS) S6D114E/202727		<b>GD650R-3</b> (MOTOR GRADERS) 6D125-1		<b>GD655A-2</b> (MOTOR GRADERS) NH220/63001	
Air Filter Set.....	A-8521-S	Fuel Filter.....	FC-5606	Air Filter Set.....	A-5604-S
Air Filter Primary.....	A-8521	<b>GD650R-3</b> (MOTOR GRADERS) 6D125-1/24001		Air Filter Secondary.....	A-5606
Air Filter Secondary.....	A-8522	Air Filter Primary.....	A-5605	Air Filter Primary.....	A-5605
Coolant Filter.....	WC-5705	Air Filter Set.....	A-5604-S	Fuel Filter.....	FC-5602
Fuel Filter Secondary.....	FC-7903	Air Filter Secondary.....	A-5606	Hydraulic Oil Filter.....	H-5620
Fuel/Water Separator.....	SFC-5708	Fuel Filter.....	FC-5602	Oil Filter By Pass.....	O-5704
Fuel/Water Separator.....	SFC-5706	Hydraulic Oil Filter.....	H-5620	Oil Filter Full Flow.....	C-5715
Hydraulic Oil Filter.....	HC-76080	Oil Filter Full Flow.....	C-5614	Oil Filter Full Flow.....	C-5605
Hydraulic Oil Filter.....	HC-5508	<b>GD655-3</b> (MOTOR GRADERS) S6D114E		Oil Filter Full Flow.....	C-5701
Oil Filter Combination.....	C-5723	Air Filter Secondary.....	A-5606	<b>GD655A-3</b> (MOTOR GRADERS) 6D125-1	
<b>GD650A-2E</b> (MOTOR GRADERS) S6D114E		Air Filter Set.....	A-5604-S	Fuel Filter.....	FC-5606
Air Filter Primary.....	A-8521	Air Filter Primary.....	A-5605	<b>GD655A-3</b> (MOTOR GRADERS) 6D125-1/64001	
Air Filter Secondary.....	A-8522	Coolant Filter.....	WC-5712	Air Filter Primary.....	A-5605
Air Filter Set.....	A-8521-S	Fuel Filter.....	FC-5613	Air Filter Set.....	A-5604-S
Coolant Filter.....	WC-5705	Fuel Filter.....	FC-5602	Air Filter Secondary.....	A-5606
Fuel Filter Secondary.....	FC-7903	Hydraulic Oil Filter.....	H-5620	Fuel Filter.....	FC-5602
Fuel/Water Separator.....	SFC-5708	Oil Filter Full Flow.....	C-5614	Hydraulic Oil Filter.....	H-5620
Fuel/Water Separator.....	SFC-5706	<b>GD655-3A</b> (MOTOR GRADERS) 2008		Oil Filter Full Flow.....	C-5614
Hydraulic Oil Filter.....	HC-5508	Air Filter Set.....	A-5558M-S	<b>GD655R-1</b> (MOTOR GRADERS) NH220/40001	
Hydraulic Oil Filter.....	HC-76080	Air Filter Primary.....	A-5558M	Air Filter Primary.....	A-5605
Oil Filter Combination.....	C-5723	Air Filter Secondary.....	A-5559	Air Filter Set.....	A-5604-S
<b>GD650AW-2C</b> (MOTOR GRADERS) S6D114E/202727		Fuel Filter.....	FC-5610	Air Filter Secondary.....	A-5606
Air Filter Set.....	A-8521-S	Fuel Filter.....	FC-5621	Fuel Filter.....	F-5601
Air Filter Primary.....	A-8521	Hydraulic Oil Filter.....	H-56600	Hydraulic Oil Filter.....	H-5620
Air Filter Secondary.....	A-8522	<b>GD655-3E0</b> (MOTOR GRADERS) SAA6D114E-3		Hydraulic Oil Filter.....	H-5608
Coolant Filter.....	WC-5705	Air Filter Set.....	A-5558M-S	Oil Filter Full Flow.....	O-5603
Fuel Filter Secondary.....	FC-7903	Air Filter Primary.....	A-5558M	Oil Filter By Pass.....	O-5704
Fuel/Water Separator.....	SFC-5708	Air Filter Secondary.....	A-5559	<b>GD655R-2</b> (MOTOR GRADERS) CUMMINS NH220	
Fuel/Water Separator.....	SFC-5706	Fuel Filter.....	FC-5613	Fuel Filter.....	FC-5606
Hydraulic Oil Filter.....	HC-76080	Hydraulic Oil Filter.....	H-56600	<b>GD655R-2</b> (MOTOR GRADERS) NH220/43001	
Hydraulic Oil Filter.....	HC-5508	<b>GD655A-1</b> (MOTOR GRADERS) NH220		Air Filter Primary.....	A-5605
Oil Filter Combination.....	C-5723	Air Filter Set.....	A-5604-S	Air Filter Set.....	A-5604-S
<b>GD650R-1</b> (MOTOR GRADERS) NH220/21001		Air Filter Secondary.....	A-5606	Air Filter Secondary.....	A-5606
Air Filter Primary.....	A-5605	Air Filter Primary.....	A-5605	Fuel Filter.....	FC-5602
Air Filter Secondary.....	A-5606	Coolant Filter.....	WC-5711	Hydraulic Oil Filter.....	H-5620
Air Filter Set.....	A-5604-S	Hydraulic Oil Filter.....	H-5620	Oil Filter Full Flow.....	C-5701
Fuel Filter.....	F-5601	Oil Filter Full Flow.....	O-5603	Oil Filter Full Flow.....	C-5715
Hydraulic Oil Filter.....	H-5608	Oil Filter By Pass.....	O-5704	Oil Filter By Pass.....	O-5704
Oil Filter Full Flow.....	O-5603	<b>GD655A-1</b> (MOTOR GRADERS) NH220/60001		Oil Filter Full Flow.....	C-5605
<b>GD650R-2</b> (MOTOR GRADERS) NH220		Air Filter Set.....	A-5604-S	<b>GD655R-3</b> (MOTOR GRADERS) 6D125-1	
Fuel Filter.....	FC-5606	Air Filter Secondary.....	A-5606	Fuel Filter.....	FC-5606
<b>GD650R-2</b> (MOTOR GRADERS) NH220/23001					

MODEL/APPLICATION	SAKURA NO	MODEL/APPLICATION	SAKURA NO	MODEL/APPLICATION	SAKURA NO
<b>KOMATSU</b>		<b>KOMATSU</b>		<b>KOMATSU</b>	
<b>GD655R-3</b> (MOTOR GRADERS) 6D125-1/44001		Air Filter Secondary.....	A-8522	Air Filter Set.....	A-5558M-S
Air Filter Primary.....	A-5605	Fuel Filter Secondary.....	FC-7903	Coolant Filter.....	WC-5711
Air Filter Set.....	A-5604-S	Fuel/Water Separator.....	SFC-5708	Fuel Filter.....	FC-5613
Air Filter Secondary.....	A-5606	Fuel/Water Separator.....	SFC-5706	Hydraulic Oil Filter.....	H-56600
Fuel Filter.....	FC-5602	Hydraulic Oil Filter.....	HC-5508		
Hydraulic Oil Filter.....	H-5620	Hydraulic Oil Filter.....	HC-76080	<b>GD675-3E0</b> (MOTOR GRADERS) SAA6D114E-3	
Oil Filter Full Flow.....	C-5614	Oil Filter Combination.....	C-5723	Air Filter Primary.....	A-5558M
				Air Filter Secondary.....	A-5559
<b>GD661A-1</b> (MOTOR GRADERS) S6D95L-1/10001		<b>GD670A-2C</b> (MOTOR GRADERS) S6D114E/202727		Air Filter Set.....	A-5558M-S
Air Filter Set.....	A-5604-S	Air Filter Primary.....	A-8521	Coolant Filter.....	WC-5711
Air Filter Secondary.....	A-5635	Air Filter Set.....	A-8521-S	Fuel Filter.....	FC-5613
Air Filter Secondary.....	A-5606	Air Filter Secondary.....	A-8522	Hydraulic Oil Filter.....	H-56600
Air Filter Primary.....	A-5605	Coolant Filter.....	WC-5705		
Air Filter Primary.....	A-5639	Fuel Filter Secondary.....	FC-7903	<b>GD655-5</b> (MOTOR GRADERS) SAA6D107E , 2010	
Hydraulic Oil Filter.....	H-5607	Fuel/Water Separator.....	SFC-5708	Air Filter Set.....	A-5558M-S
Oil Filter Full Flow.....	C-5614	Fuel/Water Separator.....	SFC-5706	Air Filter Primary.....	A-5558M
Oil Filter Full Flow.....	C-5608	Hydraulic Oil Filter.....	HC-5508	Air Filter Secondary.....	A-5559
		Hydraulic Oil Filter.....	HC-76080	Hydraulic Oil Filter.....	H-56600
		Oil Filter Combination.....	C-5723		
<b>GD663A-1</b> (MOTOR GRADERS) 6D125-1		<b>GD670A-2E</b> (MOTOR GRADERS) S6D114E		<b>GD625A-1C</b> (MOTOR GRADERS)	
Fuel Filter.....	FC-5606	Air Filter Set.....	A-8521-S	Cabin Air Filter.....	CA-56150
		Air Filter Primary.....	A-8521		
<b>GD663A-1</b> (MOTOR GRADERS) 6D125-1/30001		Air Filter Secondary.....	A-8522	<b>GD705A-3</b> (MOTOR GRADERS) NT0-6-C1	
Air Filter Set.....	A-5604-S	Coolant Filter.....	WC-5705	Fuel Filter.....	FC-5606
Air Filter Primary.....	A-5602	Fuel Filter Secondary.....	FC-7903		
Air Filter Secondary.....	A-5606	Fuel/Water Separator.....	SFC-5706	<b>GD705A-3</b> (MOTOR GRADERS) NT0-6/10002	
Air Filter Secondary.....	A-5603	Fuel/Water Separator.....	SFC-5708	Air Filter Secondary.....	A-5408
Air Filter Primary.....	A-5605	Hydraulic Oil Filter.....	HC-76080	Air Filter Primary.....	A-6113
Fuel Filter.....	FC-5602	Hydraulic Oil Filter.....	HC-5508	Fuel Filter.....	FC-5602
Hydraulic Oil Filter.....	H-5607	Oil Filter Combination.....	C-5723	Hydraulic Oil Filter.....	H-5620
Oil Filter Full Flow.....	C-5614			Oil Filter Full Flow.....	C-5605
		<b>GD670AW-2B</b> (MOTOR GRADERS) S6D114E/202487		Oil Filter Full Flow.....	C-5715
<b>GD670-1</b> (MOTOR GRADERS) CUMMINS DIESEL		Air Filter Primary.....	A-8521	Oil Filter Full Flow.....	C-5701
Air Filter Set.....	A-8521-S	Air Filter Set.....	A-8521-S	Oil Filter By Pass.....	O-5704
Air Filter Primary.....	A-8521	Air Filter Secondary.....	A-8522		
Air Filter Secondary.....	A-8522	Coolant Filter.....	WC-5705	<b>GD705A-3</b> (MOTOR GRADERS) S6D125-1	
Fuel Filter Secondary.....	FC-7903	Fuel Filter Secondary.....	FC-7903	Fuel Filter.....	FC-5606
Fuel/Water Separator.....	SFC-5708	Fuel/Water Separator.....	SFC-5706		
Fuel/Water Separator.....	SFC-5706	Fuel/Water Separator.....	SFC-5708	<b>GD705A-4</b> (MOTOR GRADERS) S6D125-1	
Hydraulic Oil Filter.....	HC-76080	Hydraulic Oil Filter.....	HC-5508	Fuel Filter.....	FC-5606
Hydraulic Oil Filter.....	HC-5508	Hydraulic Oil Filter.....	HC-76080		
Oil Filter Combination.....	C-5723	Oil Filter Combination.....	C-5723	<b>GD705A-4</b> (MOTOR GRADERS) S6D125-1/21001	
				Air Filter Primary.....	A-6113
<b>GD670-2A</b> (MOTOR GRADERS)		<b>GD670AW-2C</b> (MOTOR GRADERS) S6D114E/202727		Air Filter Secondary.....	A-5408
Air Filter Set.....	A-8521-S	Air Filter Set.....	A-8521-S	Fuel Filter.....	FC-5602
Air Filter Primary.....	A-8521	Air Filter Primary.....	A-8521	Hydraulic Oil Filter.....	H-5620
Air Filter Secondary.....	A-8522	Air Filter Secondary.....	A-8522	Oil Filter Full Flow.....	C-5605
Coolant Filter.....	WC-5706	Coolant Filter.....	WC-5705	Oil Filter Full Flow.....	C-5715
Fuel Filter Secondary.....	FC-7903	Fuel Filter Secondary.....	FC-7903	Oil Filter Full Flow.....	C-5701
Fuel/Water Separator.....	SFC-5708	Fuel/Water Separator.....	SFC-5706		
Fuel/Water Separator.....	SFC-5706	Fuel/Water Separator.....	SFC-5708	<b>GD705R-2</b> (MOTOR GRADERS) NH220/1001	
Hydraulic Oil Filter.....	HC-5508	Hydraulic Oil Filter.....	HC-5508	Air Filter Secondary.....	A-5624
Hydraulic Oil Filter.....	HC-76080	Hydraulic Oil Filter.....	HC-76080	Air Filter Set.....	A-5622-S
Oil Filter Combination.....	C-5723	Oil Filter Combination.....	C-5723	Air Filter Primary.....	A-5623
				Fuel Filter.....	F-5601
<b>GD670A-2</b> (MOTOR GRADERS) CUMMINS DIESEL		<b>GD675-3</b> (MOTOR GRADERS) SAA6D114E-3		Hydraulic Oil Filter.....	H-5611
Air Filter Set.....	A-8521-S	Air Filter Primary.....	A-5558M	Oil Filter Full Flow.....	O-5603
Air Filter Primary.....	A-8521	Air Filter Secondary.....	A-5559		

MODEL/APPLICATION	SAKURA NO	MODEL/APPLICATION	SAKURA NO	MODEL/APPLICATION	SAKURA NO
<b>KOMATSU</b>		<b>KOMATSU</b>		<b>KOMATSU</b>	
GD705R-2 (MOTOR GRADERS) NH220/1001 Oil Filter By Pass.....	0-5704	Oil Filter Full Flow.....	C-5701	Hydraulic Oil Filter Transmission...	H-65030
GD705R-4 (MOTOR GRADERS) 6D125-1 Fuel Filter.....	FC-5606	GD825A-2 (MOTOR GRADERS) S/N: 11001 Air Filter Secondary.....	A-5610	Oil Filter Full Flow.....	0-5702
GD705R-4 (MOTOR GRADERS) 6D125-1/16001 Air Filter Primary.....	A-5605	Air Filter Primary.....	A-5614	<b>H100</b> (LOADERS) NH250 Fuel Filter.....	F-5701
Air Filter Secondary.....	A-5606	Cabin Air Filter.....	CA-56150	Hydraulic Oil Filter Transmission...	H-65030
Air Filter Set.....	A-5604-S	Fuel Filter.....	FC-5703	Oil Filter Full Flow.....	0-5702
Fuel Filter.....	FC-5602	Hydraulic Oil Filter.....	H-5618	<b>H100</b> (LOADERS) NT-855 Air Filter.....	AS-5706
Hydraulic Oil Filter.....	H-5620	GF505A (MOTOR GRADERS) Air Filter Set.....	A-5604-S	Fuel Filter.....	FC-5720
Oil Filter Full Flow.....	C-5614	Air Filter Secondary.....	A-5606	Fuel Filter.....	F-5701
GD725A-1 (MOTOR GRADERS) Cabin Air Filter.....	CA-56150	Air Filter Primary.....	A-5605	Fuel Filter.....	FC-1303
GD725A-1 (MOTOR GRADERS) S6D125 Fuel Filter.....	FC-5606	Hydraulic Oil Filter.....	H-5620	Fuel/Water Separator.....	SFC-5705
GD725A-1 (MOTOR GRADERS) S6D125-1/50001 Air Filter Primary.....	A-6113	Hydraulic Oil Filter.....	H-5620	Hydraulic Oil Filter Transmission...	H-65030
Air Filter Secondary.....	A-5408	Oil Filter Full Flow.....	C-5608	Oil Filter Full Flow.....	0-5702
Fuel Filter.....	FC-5602	GS360 (STABILIZERS) NTA-855 Air Filter Secondary.....	A-5610	<b>H100 SERIES B</b> (LOADERS) IHC Fuel Filter Secondary.....	FC-54050
Hydraulic Oil Filter.....	H-5610	Air Filter Primary.....	A-5614	Fuel/Water Separator.....	SFC-5705
Hydraulic Oil Filter.....	H-56600	Fuel Filter.....	FC-5602	Hydraulic Oil Filter Transmission...	H-65030
Oil Filter Full Flow.....	C-5605	Oil Filter By Pass.....	0-5704	Oil Filter Full Flow.....	C-5402
Oil Filter Full Flow.....	C-5701	Oil Filter Full Flow.....	C-5701	<b>H100B</b> (LOADERS) BD264 Hydraulic Oil Filter Transmission...	H-65030
Oil Filter Full Flow.....	C-5715	Oil Filter Full Flow.....	C-5715	Oil Filter Full Flow.....	C-5405
GD750A-1 (MOTOR GRADERS) S/N: 7003 Fuel/Water Separator.....	SFC-5709-10	Oil Filter Full Flow.....	C-5605	<b>H100C</b> (LOADERS) DT817 Fuel Filter Secondary.....	FC-54050
Fuel/Water Separator.....	SFC-5705	GS360-1 (MOTOR GRADERS) Air Filter Secondary.....	A-5610	Oil Filter Full Flow.....	C-5402
Hydraulic Oil Filter.....	HC-76080	Air Filter Primary.....	A-5614	<b>H100C</b> (LOADERS) Fuel Filter Secondary.....	FC-54050
Oil Filter Combination.....	C-5723	Fuel Filter.....	FC-5602	Oil Filter Full Flow.....	C-5402
GD825A-1 (MOTOR GRADERS) S6D140-1/10002 Air Filter Secondary.....	A-5610	Hydraulic Oil Filter.....	H-5610	<b>H100C</b> (LOADERS) Fuel Filter Secondary.....	FC-54050
Air Filter Primary.....	A-5614	Hydraulic Oil Filter.....	H-56600	Fuel/Water Separator.....	SFC-5705
Fuel Filter.....	FC-5703	Oil Filter By Pass.....	0-5704	Oil Filter Full Flow.....	C-5402
Fuel/Water Separator.....	SFC-5707	Oil Filter Full Flow.....	C-5701	<b>H100C</b> (LOADERS) Fuel Filter Secondary.....	FC-54050
Oil Filter Full Flow.....	C-5605	Oil Filter Full Flow.....	C-5715	Oil Filter Full Flow.....	C-5402
Oil Filter Full Flow.....	C-5701	Oil Filter Full Flow.....	C-5605	<b>H101</b> (EXCAVATORS) F6L413 Air Filter Primary.....	AS-5628
Oil Filter Full Flow.....	C-5715	<b>H100</b> (LOADERS) 6V-71 Fuel Filter.....	F-6504	Air Filter Primary.....	A-5628
GD825A-2 (MOTOR GRADERS) Cabin Air Filter.....	CA-56150	Fuel Filter.....	F-6503	Air Filter Set.....	A-5628-S
GD825A-2 (MOTOR GRADERS) S6D140/12001 Air Filter Secondary.....	A-5610	Fuel Filter.....	F-6505	Fuel Filter.....	F-2604
Air Filter Primary.....	A-5614	Fuel Filter.....	F-7302	Fuel Filter.....	FC-5704
Fuel Filter.....	FC-5703	Oil Filter Full Flow.....	0-6503	Oil Filter Full Flow.....	C-6203
Fuel/Water Separator.....	SFC-5707	<b>H100</b> (LOADERS) IHC Fuel Filter Secondary.....	FC-54050	Oil Filter Full Flow.....	C-6204
Hydraulic Oil Filter.....	H-5618	Fuel/Water Separator.....	SFC-5705	<b>H101</b> (EXCAVATORS) F8L413 Air Filter Primary.....	AS-5628
Oil Filter Full Flow.....	C-5605	Hydraulic Oil Filter Transmission...	H-65030	Air Filter Primary.....	A-5628
Oil Filter Full Flow.....	C-5715	Oil Filter Full Flow.....	C-5402	Air Filter Set.....	A-5628-S
		<b>H100</b> (LOADERS) NH220 Fuel Filter.....	F-5701	Fuel Filter.....	FC-5704
				Fuel Filter.....	F-2604



MODEL/APPLICATION	SAKURA NO	MODEL/APPLICATION	SAKURA NO	MODEL/APPLICATION	SAKURA NO
<b>KOMATSU</b>		<b>KOMATSU</b>		<b>KOMATSU</b>	
<b>H101</b> (EXCAVATORS) F8L413		Fuel Filter Secondary.....	FC-6502	Oil Filter By Pass.....	C-5718
Oil Filter Full Flow.....	C-6203	Fuel Filter Primary.....	FC-6501	<b>H25</b> (LOADERS) B	
Oil Filter Full Flow.....	C-6204	Fuel/Water Separator.....	SFC-7301	Air Filter Primary.....	AS-2205
<b>H111</b> (EXCAVATORS) GM		Oil Filter Full Flow.....	O-6503	<b>H25B</b> (LOADERS)	
Air Filter Primary.....	A-7912	<b>H121</b> (EXCAVATORS) VTA-1710		Air Filter Primary.....	AS-7609
Air Filter Set.....	A-7912-S	Coolant Filter.....	WC-5711	Fuel Filter.....	FC-5103
Air Filter Secondary.....	A-7915	Fuel Filter.....	FC-5703	Oil Filter Full Flow.....	O-1803
<b>H120</b> (LOADERS) 8V-71		Fuel/Water Separator.....	SFC-5707	Oil Filter Full Flow.....	O-2619
Fuel Filter.....	F-7302	Oil Filter By Pass.....	C-5718	<b>H25 SERIES B</b> (LOADERS) 180DLC	
Fuel Filter.....	F-6503	Oil Filter Full Flow.....	C-5715	Air Filter Primary.....	AS-7609
Oil Filter Full Flow.....	O-6503	<b>H15C</b> (COMPACTORS) F4L912		Air Filter Secondary.....	A-7605
<b>H120</b> (LOADERS)		Oil Filter Full Flow.....	C-6202	Air Filter Primary.....	AS-1014
Air Filter.....	A-8545	<b>H21C</b> (EXCAVATORS) F5L912		<b>H25 SERIES B</b> (LOADERS) 180GKB	
Fuel Filter Secondary.....	FC-54050	Air Filter.....	AS-1010	Air Filter Primary.....	AS-1014
Fuel/Water Separator.....	SFC-5705	Fuel Filter.....	FC-5704	<b>H25 SERIES B</b> (LOADERS) D188	
<b>H120 SERIES B</b> (LOADERS) 8V-71		Oil Filter Full Flow.....	C-6204	Air Filter Primary.....	AS-5628
Fuel Filter.....	F-6503	<b>H21P</b> (EXCAVATORS) F5L912		Air Filter Primary.....	A-5628
Fuel Filter.....	F-7302	Air Filter.....	AS-1010	Air Filter Set.....	A-5628-S
Oil Filter Full Flow.....	O-6503	Fuel Filter.....	FC-5704	Air Filter Primary.....	AS-1014
<b>H120 SERIES C</b> (LOADERS) 8V-71		Oil Filter Full Flow.....	C-6204	<b>H285S</b> (EXCAVATORS) CUMMINS	
Fuel Filter.....	F-7302	<b>H23C</b> (EXCAVATORS) F6L912		Air Filter Secondary.....	A-7902
Fuel Filter.....	F-6503	Fuel Filter.....	FC-5704	Coolant Filter.....	WC-5703
Oil Filter Full Flow.....	O-6503	Oil Filter Full Flow.....	C-6204	Fuel Filter.....	FC-5703
<b>H120B</b> (LOADERS)		<b>H23LC</b> (EXCAVATORS) F6L912		Fuel/Water Separator.....	SFC-5707
Air Filter.....	A-8545	Fuel Filter.....	FC-5704	Oil Filter Full Flow.....	C-5605
Fuel Filter Secondary.....	FC-54050	Oil Filter Full Flow.....	C-6204	Oil Filter Full Flow.....	C-5701
Fuel/Water Separator.....	SFC-5705	<b>H240</b> (CRANES) F6L912		Oil Filter By Pass.....	C-5718
<b>H120C</b> (LOADERS) DT817		Air Filter Secondary.....	A-6302	<b>H30</b> (LOADERS)	
Air Filter.....	A-8545	Air Filter Primary.....	A-6207	Air Filter Primary.....	AS-5628
Air Filter Secondary.....	A-5417	Fuel Filter.....	FC-5704	Air Filter Primary.....	A-5628
Air Filter Primary.....	A-5425	Oil Filter Full Flow.....	C-6204	Air Filter Set.....	A-5628-S
Hydraulic Oil Filter Transmission....	H-65030	<b>H241</b> (EXCAVATORS) 16V-149T		Fuel Filter.....	F-2603
<b>H120C</b> (LOADERS) DT817B		Fuel Filter Primary.....	FC-6501	Fuel Filter.....	F-2604
Air Filter Secondary.....	A-5417	Fuel Filter Secondary.....	FC-6502	<b>H30 SERIES B</b> (LOADERS) 3-53	
Air Filter Primary.....	A-5425	Fuel/Water Separator.....	SFC-7301	Air Filter Primary.....	A-5628
Air Filter.....	A-8545	Oil Filter Full Flow.....	O-6503	Air Filter Set.....	A-5628-S
Fuel Filter Secondary.....	FC-54050	<b>H241</b> (EXCAVATORS) 16V-71T		Air Filter Primary.....	AS-1014
Fuel/Water Separator.....	SFC-5705	Fuel Filter Primary.....	FC-6501	Air Filter Primary.....	AS-5628
Hydraulic Oil Filter Transmission....	H-65030	Fuel Filter Secondary.....	FC-6502	Fuel Filter.....	F-6505
<b>H121</b> (EXCAVATORS) 16V-71T		Fuel/Water Separator.....	SFC-7301	Fuel Filter Secondary.....	F-6502
Fuel Filter Primary.....	FC-6501	Oil Filter Full Flow.....	O-6503	Hydraulic Oil Filter Transmission....	H-65030
Fuel Filter Secondary.....	FC-6502	<b>H241</b> (EXCAVATORS) KTA-D19893067		Oil Filter Full Flow.....	O-6503
Fuel/Water Separator.....	SFC-7301	Coolant Filter.....	WC-5711	<b>H30 SERIES B</b> (LOADERS) G-263	
Oil Filter Full Flow.....	O-6503	Fuel Filter.....	FC-5703	Hydraulic Oil Filter Transmission....	H-65030
<b>H121</b> (EXCAVATORS) 16V-71T		Fuel/Water Separator.....	SFC-5707	<b>H30 SERIES B</b> (LOADERS) UD-236	
Fuel Filter Primary.....	FC-6501	Oil Filter Full Flow.....	C-5605	Air Filter Primary.....	AS-5628
Fuel Filter Secondary.....	FC-6502	Oil Filter Full Flow.....	C-5701	Air Filter Primary.....	A-5628

MODEL/APPLICATION	SAKURA NO	MODEL/APPLICATION	SAKURA NO	MODEL/APPLICATION	SAKURA NO
<b>KOMATSU</b>		<b>KOMATSU</b>		<b>KOMATSU</b>	
<b>H30 SERIES B (LOADERS) UD-236</b>		Hydraulic Oil Filter Transmission... H-65030		<b>H36 (EXCAVATORS) F8L413</b>	
Air Filter Set.....	A-5628-S	<b>H-30R SERIES B (LOADERS) U-240</b>		Air Filter Set.....	A-5628-S
Air Filter.....	AS-1010	Hydraulic Oil Filter Transmission... H-65030		Air Filter Primary.....	A-5628
Air Filter Primary.....	AS-1014	<b>H31 (EXCAVATORS) F6L413</b>		Air Filter Primary.....	AS-5628
Hydraulic Oil Filter Transmission...	H-65030	Air Filter Primary..... AS-5628		Fuel Filter.....	FC-5704
<b>H30B (LOADERS) D239</b>		Air Filter Primary..... A-5628		Fuel Filter.....	F-2604
Fuel Filter.....	F-2604	Air Filter Set..... A-5628-S		Oil Filter Full Flow.....	C-6203
Fuel Filter.....	F-2603	Fuel Filter..... FC-5704		Oil Filter Full Flow.....	C-6204
<b>H30B (LOADERS)</b>		Fuel Filter..... F-2604		<b>H-40 (LOADERS) G-264</b>	
Air Filter Primary.....	AS-5628	Oil Filter Full Flow..... C-6204		Air Filter.....	AS-1010
Air Filter Primary.....	AS-7609	Oil Filter Full Flow..... C-6203		Hydraulic Oil Filter Transmission...	H-65030
Air Filter Primary.....	A-5628	<b>H31 (EXCAVATORS) F8L413</b>		<b>H-40 (LOADERS) UD-282</b>	
Air Filter Set.....	A-5628-S	Air Filter Primary..... AS-5628		Hydraulic Oil Filter Transmission... H-65030	
Air Filter Secondary.....	A-7605	Air Filter Primary..... A-5628		<b>H400 (LOADERS) 12V-71</b>	
Fuel Filter.....	F-2604	Air Filter Set..... A-5628-S		Fuel Filter..... F-6504	
Hydraulic Oil Filter Transmission...	H-65030	Fuel Filter..... FC-5704		Hydraulic Oil Filter Transmission... H-65030	
<b>H30F SERIES B (LOADERS) 3-53</b>		Fuel Filter..... F-2604		Oil Filter Full Flow..... O-6503	
Air Filter Primary.....	AS-5628	Oil Filter Full Flow..... C-6204		<b>H400 (LOADERS) VT-12-525</b>	
Air Filter Primary.....	AS-1014	Oil Filter Full Flow..... C-6203		Fuel Filter..... F-5701	
Air Filter Set.....	A-5628-S	<b>H31LC (EXCAVATORS) F6L413</b>		Hydraulic Oil Filter Transmission... H-65030	
Air Filter Primary.....	A-5628	Air Filter Primary..... AS-5628		Oil Filter Full Flow..... C-8031	
Fuel Filter Secondary.....	F-6502	Air Filter Primary..... A-5628		Oil Filter Full Flow..... O-5702	
Fuel Filter.....	F-6505	Air Filter Set..... A-5628-S		<b>H400C (LOADERS)</b>	
Hydraulic Oil Filter Transmission...	H-65030	Fuel Filter..... F-2604		Air Filter Secondary..... A-5417	
Oil Filter Full Flow.....	O-6503	Fuel Filter..... FC-5704		Air Filter Primary..... A-5425	
<b>H30F SERIES B (LOADERS) D301</b>		Oil Filter Full Flow..... C-6203		Coolant Filter..... WC-5707	
Air Filter Primary.....	A-5628	Oil Filter Full Flow..... C-6204		Fuel Filter..... FC-5703	
Air Filter Primary.....	AS-5628	<b>H31P (EXCAVATORS) F6L413</b>		Fuel/Water Separator..... SFC-5707	
Air Filter Primary.....	AS-7609	Air Filter Primary..... AS-5628		Oil Filter Full Flow..... C-5715	
Air Filter Primary.....	AS-1014	Air Filter Primary..... A-5628		Oil Filter By Pass..... C-5718	
Air Filter Secondary.....	A-7605	Air Filter Set..... A-5628-S		<b>H40B (LOADERS)</b>	
Air Filter.....	AS-1010	Fuel Filter..... F-2604		Air Filter Primary..... AS-5628	
Air Filter Set.....	A-5628-S	Fuel Filter..... FC-5704		Air Filter Primary..... A-5628	
<b>H30F SERIES B (LOADERS) G-263</b>		Oil Filter Full Flow..... C-6204		Air Filter Set..... A-5628-S	
Hydraulic Oil Filter Transmission...	H-65030	Oil Filter Full Flow..... C-6203		<b>H41 (EXCAVATORS) F10L413F</b>	
<b>H30F SERIES B (LOADERS) UD-236</b>		<b>H31P (EXCAVATORS) F8L413</b>		Air Filter Primary..... AS-5628	
Air Filter Primary.....	AS-5628	Air Filter Primary..... AS-5628		Air Filter Primary..... A-5628	
Air Filter.....	AS-1010	Air Filter Primary..... A-5628		Air Filter Set..... A-5628-S	
Air Filter Primary.....	AS-1014	Air Filter Set..... A-5628-S		Fuel Filter..... FC-5704	
Air Filter Set.....	A-5628-S	Fuel Filter..... F-2604		Fuel Filter..... F-2604	
Air Filter Primary.....	A-5628	Oil Filter Full Flow..... C-6203		Fuel Filter..... FC-6202	
Hydraulic Oil Filter Transmission...	H-65030	Oil Filter Full Flow..... C-6204		Oil Filter Full Flow..... C-6204	
<b>H-30R SERIES B (LOADERS) 3-53</b>		<b>H36 (EXCAVATORS) F6L413</b>		<b>H-50 (LOADERS) UB-264</b>	
Fuel Filter.....	F-6505	Air Filter Primary..... AS-5628		Air Filter..... AS-1010	
Fuel Filter Secondary.....	F-6502	Air Filter Primary..... A-5628		<b>H-50 SERIES B (LOADERS) 3-53</b>	
Hydraulic Oil Filter Transmission...	H-65030	Air Filter Set..... A-5628-S		Fuel Filter..... F-6505	
Oil Filter Full Flow.....	O-6503	Fuel Filter..... F-2604		Fuel Filter Secondary..... F-6502	
<b>H-30R SERIES B (LOADERS) U-236</b>		Fuel Filter..... FC-5704		Hydraulic Oil Filter Transmission... H-65030	
		Oil Filter Full Flow..... C-6204			
		Oil Filter Full Flow..... C-6203			

# Sakura Filter

# ENGINE APPLICATION

MODEL/APPLICATION	SAKURA NO
<b>KOMATSU</b>	
<b>H-50 SERIES B</b> (LOADERS) 3-53	
Oil Filter Full Flow.....	0-6503
<b>H-50 SERIES B</b> (LOADERS) G-301	
Hydraulic Oil Filter Transmission....	H-65030
<b>H-50 SERIES B</b> (LOADERS) UD-282	
Hydraulic Oil Filter Transmission....	H-65030
<b>H-50 SERIES C</b> (LOADERS) 3-53	
Air Filter.....	AS-1010
Fuel Filter Secondary.....	F-6502
Fuel Filter.....	F-6505
Oil Filter Full Flow.....	0-6503
<b>H-50 SERIES C</b> (LOADERS) G-301	
Air Filter Primary.....	AS-5628
Air Filter Primary.....	A-5628
Air Filter Set.....	A-5628-S
<b>H50B</b> (LOADERS)	
Fuel Filter.....	FC-5403
Hydraulic Oil Filter Transmission....	H-65030
Oil Filter Full Flow.....	C-6204
<b>H50C</b> (LOADERS)	
Air Filter Primary.....	AS-5628
Air Filter Primary.....	A-5628
Air Filter Set.....	A-5628-S
Oil Filter Full Flow.....	C-5814
<b>H51</b> (EXCAVATORS) F10L413F	
Air Filter Primary.....	A-5628
Air Filter Set.....	A-5628-S
Air Filter Primary.....	AS-5628
Fuel Filter.....	FC-6202
Fuel Filter.....	F-2604
Oil Filter Full Flow.....	C-6204
<b>H51</b> (EXCAVATORS) VT-903	
Coolant Filter.....	WC-5705
Fuel Filter.....	FC-5702
Oil Filter Full Flow.....	C-5715
Oil Filter By Pass.....	C-5718
<b>H60</b> (LOADERS) 3-71	
Fuel Filter.....	F-6505
Fuel Filter Secondary.....	F-6502
Hydraulic Oil Filter Transmission....	H-65030
Oil Filter Full Flow.....	0-6503
<b>H60</b> (LOADERS) G-372	
Hydraulic Oil Filter Transmission....	H-65030
<b>H60</b> (LOADERS)	
Hydraulic Oil Filter Transmission....	H-65030

MODEL/APPLICATION	SAKURA NO
<b>KOMATSU</b>	
Fuel Filter.....	F-2604
Fuel Filter.....	FC-5403
Fuel Filter.....	F-2603
Hydraulic Oil Filter Transmission....	H-65030
Oil Filter Full Flow.....	C-6204
<b>H-60 SERIES B</b> (LOADERS) D301	
Air Filter Primary.....	AS-5628
Air Filter Primary.....	A-5628
Air Filter Set.....	A-5628-S
<b>H-60 SERIES B</b> (LOADERS) G-301	
Air Filter Primary.....	AS-5628
Air Filter Primary.....	A-5628
Air Filter Set.....	A-5628-S
<b>H-60 SERIES B</b> (LOADERS) V-352-C	
Air Filter Primary.....	AS-1024
Air Filter Set.....	AS-1024-S
Air Filter.....	AS-1010
Air Filter Secondary.....	A-7809
Fuel Filter.....	FC-1303
Fuel Filter.....	FC-5720
Fuel/Water Separator.....	SFC-5705
Oil Filter Full Flow.....	0-5703
<b>H60B</b> (LOADERS)	
Air Filter Primary.....	AS-1024
Air Filter Set.....	AS-1024-S
Air Filter Secondary.....	A-7809
Fuel Filter.....	FC-7933
Fuel Filter.....	FC-5103
Fuel/Water Separator.....	SFC-5705
Oil Filter Full Flow.....	C-6204
<b>H60E</b> (LOADERS)	
Air Filter Primary.....	AS-1024
Air Filter Set.....	AS-1024-S
Air Filter Secondary.....	A-7809
Fuel Filter.....	FC-1810
Fuel Filter.....	FC-7933
Fuel/Water Separator.....	SFC-5705
<b>H65</b> (EXCAVATORS)	
Air Filter Secondary.....	A-5417
Air Filter Primary.....	A-5425
Fuel Filter.....	FC-5702
Hydraulic Oil Filter.....	HC-5502
Oil Filter Full Flow.....	C-7602
<b>H-65 SERIES B</b> (LOADERS) 3-71	
Fuel Filter.....	F-6505
Fuel Filter Secondary.....	F-6502
Hydraulic Oil Filter Transmission....	H-65030
Oil Filter Full Flow.....	0-6503
<b>H-65 SERIES B</b> (LOADERS) 6	
Hydraulic Oil Filter Transmission....	H-65030
Oil Filter Full Flow.....	0-6503

MODEL/APPLICATION	SAKURA NO
<b>KOMATSU</b>	
Air Filter.....	AS-1010
<b>H-65 SERIES C</b> (LOADERS) DT361	
Fuel Filter.....	FC-1810
Fuel/Water Separator.....	SFC-5705
<b>H-65 SERIES C</b> (LOADERS) DT407	
Air Filter Primary.....	A-2210
Air Filter Secondary.....	A-6008
Fuel Filter.....	FC-1810
Fuel/Water Separator.....	SFC-5705
<b>H65C</b> (LOADERS) DT414	
Fuel Filter.....	FC-1810
Fuel Filter.....	FC-7933
<b>H65C</b> (LOADERS)	
Fuel Filter.....	FC-5103
Oil Filter Full Flow.....	C-6204
<b>H-70</b> (LOADERS) 3-71	
Fuel Filter.....	F-6505
Fuel Filter Secondary.....	F-6502
Oil Filter Full Flow.....	0-6503
<b>H-70 SERIES B</b> (LOADERS) 3-71	
Fuel Filter.....	F-6505
Fuel Filter Secondary.....	F-6502
Oil Filter Full Flow.....	0-6503
<b>H-70 SERIES B</b> (LOADERS) U-372	
Hydraulic Oil Filter Transmission....	H-65030
<b>H-70 SERIES C</b> (LOADERS) 4-71	
Fuel Filter.....	F-6505
Fuel Filter Secondary.....	F-6502
Hydraulic Oil Filter Transmission....	H-65030
Oil Filter Full Flow.....	0-6503
<b>H-70 SERIES C</b> (LOADERS) C-160	
Fuel Filter.....	F-5701
Hydraulic Oil Filter Transmission....	H-65030
Oil Filter Full Flow.....	0-5702
<b>H-70 SERIES F</b> (LOADERS) 4-71	
Fuel Filter.....	F-6505
Fuel Filter Secondary.....	F-6502
Hydraulic Oil Filter Transmission....	H-65030
Oil Filter Full Flow.....	0-6503
<b>H-70 SERIES F</b> (LOADERS) C-160	
Fuel Filter.....	F-5701
Hydraulic Oil Filter Transmission....	H-65030
Oil Filter Full Flow.....	0-5702
<b>H71</b> (EXCAVATORS) 3406	

MODEL/APPLICATION	SAKURA NO	MODEL/APPLICATION	SAKURA NO	MODEL/APPLICATION	SAKURA NO
<b>KOMATSU</b>		<b>KOMATSU</b>		<b>KOMATSU</b>	
<b>H71</b> (EXCAVATORS) 3406		Fuel Filter.....	FC-1303	<b>HA250-1</b> (ARTICULATED TRUCKS) S6D125-1	
Air Filter Secondary.....	A-55291	Fuel/Water Separator.....	SFC-5705	Fuel Filter.....	FC-5602
Air Filter Set.....	A-55211-S	Hydraulic Oil Filter Transmission...	H-65030	Oil Filter Full Flow.....	C-5605
Air Filter Primary.....	A-55211	Oil Filter Full Flow.....	O-5702	Oil Filter Full Flow.....	C-5701
Fuel Filter.....	FC-5501			Oil Filter Full Flow.....	C-5715
Fuel/Water Separator.....	SFC-5705	<b>H-90 SERIES C</b> (LOADERS) 6V-53		<b>HA250-2</b> (ARTICULATED TRUCKS) S6D125-1	
Oil Filter Full Flow.....	C-5516	Fuel Filter.....	F-6505	Fuel Filter.....	FC-5602
Oil Filter Full Flow.....	C-5523	Fuel Filter Secondary.....	F-6502	Oil Filter Full Flow.....	C-5605
		Oil Filter Full Flow.....	O-6503	Oil Filter Full Flow.....	C-5715
				Oil Filter Full Flow.....	C-5701
<b>H71</b> (EXCAVATORS) NT-855		<b>H-90 SERIES C</b> (LOADERS) DT573		<b>HA250-2A</b> (ARTICULATED TRUCKS) S6D125-1	
Air Filter Secondary.....	A-5417	Fuel Filter Secondary.....	FC-54050	Fuel Filter.....	FC-5602
Air Filter Primary.....	A-5425			Oil Filter Full Flow.....	C-5715
Coolant Filter.....	WC-5705	<b>H-90 SERIES C</b> (LOADERS) DVT-573		Oil Filter Full Flow.....	C-5605
Fuel Filter.....	FC-5702	Fuel Filter Secondary.....	FC-54050	Oil Filter Full Flow.....	C-5701
Oil Filter By Pass.....	O-5704				
Oil Filter Full Flow.....	C-5715	<b>H-90 SERIES C</b> (LOADERS) V6R-180-C1		<b>HA270</b> (DUMP TRUCKS) 65226	
		Fuel Filter.....	FC-5720	Air Filter Secondary.....	A-5408
<b>H-80</b> (LOADERS) DT429		Fuel Filter.....	FC-1303	Fuel Filter.....	FC-5602
Fuel Filter.....	FC-1810	Fuel/Water Separator.....	SFC-5705	Hydraulic Oil Filter.....	H-7972
Fuel/Water Separator.....	SFC-5705	Hydraulic Oil Filter Transmission...	H-65030	Oil Filter Full Flow.....	C-5605
		Oil Filter Full Flow.....	O-5702	Oil Filter Full Flow.....	C-5701
<b>H80A</b> (LOADERS) DT429				Oil Filter Full Flow.....	C-5715
Fuel Filter.....	FC-1810	<b>H90E</b> (LOADERS) DT573			
Fuel/Water Separator.....	SFC-5705	Fuel Filter.....	FC-1810	<b>HA270-1</b> (DUMP TRUCKS) S6D125-1	
		Fuel/Water Separator.....	SFC-5705	Fuel Filter.....	FC-5602
<b>H80B</b> (LOADERS) DT466		Oil Filter Full Flow.....	C-5402	Oil Filter Full Flow.....	C-5701
Coolant Filter.....	WC-5708	<b>H90E</b> (LOADERS) DT573B		Oil Filter Full Flow.....	C-5715
Coolant Filter.....	WC-5705	Air Filter.....	A-5410	Oil Filter Full Flow.....	C-5701
Fuel Filter.....	FC-1810	Fuel Filter Secondary.....	FC-54050	Oil Filter Full Flow.....	C-5605
Fuel Filter.....	FC-7933	Fuel Filter.....	FC-1810		
Fuel/Water Separator.....	SFC-5705	Fuel Filter.....	FC-7933	<b>HA270-2</b> (DUMP TRUCKS) S6D125-1	
		Fuel/Water Separator.....	SFC-5705	Fuel Filter.....	FC-5602
<b>H80B</b> (LOADERS)		Oil Filter Full Flow.....	C-5402	Oil Filter Full Flow.....	C-5715
Air Filter.....	A-5434	<b>H90E</b> (LOADERS)		Oil Filter Full Flow.....	C-5701
Fuel Filter.....	FC-7933	Air Filter.....	A-5410	Oil Filter Full Flow.....	C-5605
Fuel Filter.....	FC-1810	Air Filter Primary.....	A-5420		
Fuel/Water Separator.....	SFC-5705	Air Filter Set.....	A-5420-S	<b>HA270-2A</b> (DUMP TRUCKS) S6D125-1	
		Fuel Filter.....	FC-1810	Fuel Filter.....	FC-5602
<b>H-90</b> (LOADERS) 4-71		Fuel/Water Separator.....	SFC-5705	Oil Filter Full Flow.....	C-5605
Fuel Filter.....	F-6505			Oil Filter Full Flow.....	C-5715
Fuel Filter Secondary.....	F-6502	<b>H95</b> (EXCAVATORS) CUMMINS		Oil Filter Full Flow.....	C-5701
Hydraulic Oil Filter Transmission...	H-65030	Air Filter Primary.....	A-5718		
Oil Filter Full Flow.....	O-6503	Air Filter Secondary.....	A-5715	<b>HAMMER</b> (LOADERS) D226	
		Fuel/Water Separator.....	SFC-5709-10	Oil Filter Full Flow.....	C-1914
<b>H-90</b> (LOADERS) WXLC-3		Fuel/Water Separator.....	SFC-5705		
Hydraulic Oil Filter Transmission...	H-65030	Oil Filter By Pass.....	C-5718	<b>HB215LC-1/HYBRID</b> (EXCAVATORS) SAA4D107E-1 , 2011	
		Oil Filter Full Flow.....	C-5715	Air Filter Primary.....	A-5666
<b>H-90 SERIES B</b> (LOADERS) 4-71				Air Filter Secondary.....	A-5667
Fuel Filter.....	F-6505	<b>HA250</b> (ARTICULATED TRUCKS) S/N: 60636		Hydraulic Oil Filter.....	H-5646
Fuel Filter Secondary.....	F-6502	Fuel Filter.....	FC-5602	Hydraulic Oil Filter.....	H-5629
Hydraulic Oil Filter Transmission...	H-65030	Oil Filter Full Flow.....	C-5605	Hydraulic Breather.....	H-56610
Oil Filter Full Flow.....	O-6503	Oil Filter Full Flow.....	C-5715		
		Oil Filter Full Flow.....	C-5701	<b>HB205LC-1 / HYBRID</b> (EXCAVATORS) SAA4D107E-1-A	
<b>H-90 SERIES B</b> (LOADERS) C-175				Air Filter Secondary.....	A-5667
Fuel Filter.....	FC-5720				
Fuel Filter.....	F-5701				

# Sakura Filter

# ENGINE APPLICATION

MODEL/APPLICATION	SAKURA NO	MODEL/APPLICATION	SAKURA NO	MODEL/APPLICATION	SAKURA NO
<b>KOMATSU</b>		<b>KOMATSU</b>		<b>KOMATSU</b>	
<b>HB205LC-1 / HYBRID</b> (EXCAVATORS) SAA4D107E-1-A		Air Filter Secondary.....	A-6302	Fuel Filter.....	F-2603
Air Filter Primary.....	A-5666	Air Filter Primary.....	A-6207	Fuel Filter.....	FC-5704
Hydraulic Oil Filter.....	H-5646	Fuel Filter.....	F-2603	Oil Filter Full Flow.....	C-6204
Hydraulic Oil Filter.....	H-5629	Fuel Filter.....	FC-6202	Oil Filter Full Flow.....	C-6203
Hydraulic Breather.....	H-56610	Fuel Filter.....	FC-5704		
		Fuel Filter.....	F-2604		
<b>HC120</b> (CRANES) F10L413		Oil Filter Full Flow.....	C-6204	<b>HD1200M</b> (DUMP TRUCKS) KT2300	
Fuel Filter.....	FC-6202	Oil Filter Full Flow.....	C-6203	Air Filter Primary.....	A-5629
Fuel Filter.....	F-2603			Air Filter Secondary.....	A-5630
Fuel Filter.....	F-2604			Air Filter Set.....	A-5629-S
Oil Filter Full Flow.....	C-6203			Coolant Filter.....	WC-5711
Oil Filter Full Flow.....	C-6204			Coolant Filter.....	WC-5705
				Fuel Filter.....	FC-5703
<b>HC120</b> (CRANES) F6/8L413				Fuel/Water Separator.....	SFC-5707
Fuel Filter.....	FC-5704			Hydraulic Oil Filter.....	H-5606
Fuel Filter.....	F-2603			Oil Filter By Pass.....	C-5718
Fuel Filter.....	F-2604			Oil Filter Full Flow.....	C-5715
Oil Filter Full Flow.....	C-6203				
Oil Filter Full Flow.....	C-6204			<b>HD1200M</b> (DUMP TRUCKS) KTA-2300	
				Air Filter Set.....	A-5629-S
<b>HC170</b> (CRANES) F6L912				Air Filter Primary.....	A-5629
Fuel Filter.....	FC-5704			Air Filter Secondary.....	A-5630
Oil Filter Full Flow.....	C-6204			Coolant Filter.....	WC-5711
Oil Filter Full Flow.....	C-6203			Coolant Filter.....	WC-5705
				Fuel Filter.....	FC-5703
<b>HC170</b> (CRANES) F8L413F				Fuel/Water Separator.....	SFC-5707
Fuel Filter.....	FC-5704			Hydraulic Oil Filter.....	H-5606
Oil Filter Full Flow.....	C-6204			Oil Filter By Pass.....	C-5718
Oil Filter Full Flow.....	C-6203			Oil Filter Full Flow.....	C-5715
<b>HC240</b> (CRANES) F10L413				<b>HD1200M-1</b> (DUMP TRUCKS) S/N: 1501	
Fuel Filter.....	F-2604			Air Filter Primary.....	A-9218
Fuel Filter.....	FC-6202			Air Filter Secondary.....	A-9205
Oil Filter Full Flow.....	C-6203			Air Filter Set.....	A-9218-S
Oil Filter Full Flow.....	C-6204			Coolant Filter.....	WC-6901
				Fuel Filter.....	FC-5703
<b>HC320</b> (CRANES) F12L413F				Fuel/Water Separator.....	SFC-5707
Air Filter Secondary.....	A-6302			Hydraulic Oil Filter.....	H-7911
Air Filter Primary.....	A-6207			Hydraulic Oil Filter.....	H-85680
Fuel Filter.....	F-2603			Oil Filter Full Flow.....	C-5715
Fuel Filter.....	FC-6202			Oil Filter Full Flow.....	C-5701
Fuel Filter.....	F-2604			Oil Filter Full Flow.....	C-5605
Fuel Filter.....	FC-5704				
Oil Filter Full Flow.....	C-6203			<b>HD1600M-1</b> (DUMP TRUCKS) KTA-3067/1005	
Oil Filter Full Flow.....	C-6204			Air Filter Set.....	A-9218-S
				Air Filter Secondary.....	A-9205
<b>HC320</b> (CRANES) F6L912				Air Filter Primary.....	A-9218
Air Filter Primary.....	A-6207			Coolant Filter.....	WC-5705
Air Filter Primary.....	A-6211			Fuel Filter.....	FC-5703
Air Filter Secondary.....	A-6212			Fuel/Water Separator.....	SFC-5707
Air Filter Secondary.....	A-6302			Hydraulic Oil Filter.....	H-7911
Fuel Filter.....	FC-5704			Hydraulic Oil Filter.....	H-85680
Oil Filter Full Flow.....	C-6204			Oil Filter By Pass.....	C-5718
Oil Filter Full Flow.....	C-6203			Oil Filter Full Flow.....	C-5701
				Oil Filter Full Flow.....	C-5605
<b>HC360</b> (CRANES) F12L413F					
				<b>HD180-4</b> (DUMP TRUCKS) NTO-6	
				Air Filter Secondary.....	A-5408
				Air Filter Primary.....	A-6113

# Sakura Filter

# ENGINE APPLICATION

MODEL/APPLICATION	SAKURA NO	MODEL/APPLICATION	SAKURA NO	MODEL/APPLICATION	SAKURA NO
<b>KOMATSU</b>		<b>KOMATSU</b>		<b>KOMATSU</b>	
<b>HD180-4</b> (DUMP TRUCKS) NTO-6		Oil Filter By Pass.....	O-5704	Hydraulic Oil Filter.....	H-5618
Fuel Filter.....	FC-5602	Oil Filter Full Flow.....	C-5701	Oil Filter Full Flow.....	C-5715
Fuel Filter.....	F-5601	Oil Filter Full Flow.....	C-5715	Oil Filter Full Flow.....	C-5605
Hydraulic Oil Filter.....	H-5620			Oil Filter Full Flow.....	C-5701
Hydraulic Oil Filter.....	H-5611	<b>HD200-2</b> (DUMP TRUCKS) NTC-743/1002			
Oil Filter Full Flow.....	C-5605	Air Filter Secondary.....	A-5408	<b>HD320-2</b> (DUMP TRUCKS) NTA-855	
Oil Filter Full Flow.....	O-5603	Air Filter Primary.....	A-6113	Air Filter Secondary.....	A-5408
Oil Filter By Pass.....	O-5704	Fuel Filter.....	FC-5602	Coolant Filter.....	WC-5711
Oil Filter Full Flow.....	C-5701	Fuel Filter.....	F-5601	Fuel Filter.....	FC-5602
Oil Filter Full Flow.....	C-5715	Hydraulic Oil Filter.....	H-5620	Hydraulic Oil Filter.....	H-56600
		Hydraulic Oil Filter.....	H-5611	Hydraulic Oil Filter.....	H-5610
		Oil Filter Full Flow.....	C-5605	Oil Filter By Pass.....	O-5704
		Oil Filter Full Flow.....	C-5701	Oil Filter Full Flow.....	C-5605
		Oil Filter Full Flow.....	O-5603	Oil Filter Full Flow.....	C-5715
		Oil Filter Full Flow.....	C-5715	Oil Filter Full Flow.....	C-5701
		Oil Filter By Pass.....	O-5704		
<b>HD180-4</b> (DUMP TRUCKS) NTO-6-B				<b>HD320-3</b> (DUMP TRUCKS) CUMMINS NTA-855	
Fuel Filter.....	FC-5606	<b>HD200D-3</b> (DUMP TRUCKS) S6D125-1		Fuel Filter.....	FC-5606
		Fuel Filter.....	FC-5606		
<b>HD1500-5</b> (DUMP TRUCKS) QSK45		<b>HD200D-3</b> (DUMP TRUCKS) S6D125-1/1001		<b>HD320-3</b> (DUMP TRUCKS) NTA-855	
Coolant Filter.....	WC-5712	Air Filter Primary.....	A-6113	Coolant Filter.....	WC-5711
Coolant Filter.....	WC-5713	Air Filter Secondary.....	A-5408	Fuel Filter.....	FC-5602
Fuel/Water Separator.....	SFC-5601-02	Fuel Filter.....	FC-5602	Hydraulic Oil Filter.....	H-5609
		Hydraulic Oil Filter.....	H-5611	Oil Filter Full Flow.....	C-5701
		Hydraulic Oil Filter.....	H-5609	Oil Filter By Pass.....	O-5704
<b>HD1500-5</b> (DUMP TRUCKS) SDA12V160		Oil Filter Full Flow.....	C-5701	Oil Filter Full Flow.....	C-5605
Air Filter Secondary.....	A-7902	Oil Filter Full Flow.....	C-5605	Oil Filter Full Flow.....	C-5715
		Oil Filter Full Flow.....	C-5715		
<b>HD1500-7</b> (DUMP TRUCKS) KOMATSU SDA16V159E-2		<b>HD205-3</b> (DUMP TRUCKS) S6D125-1/1003		<b>HD320-3</b> (DUMP TRUCKS) NTA-855/2501	
Hydraulic Oil Filter.....	H-56740	Air Filter Primary.....	A-6113	Air Filter Primary.....	A-6113
		Air Filter Secondary.....	A-5408	Air Filter Secondary.....	A-5408
		Fuel Filter.....	FC-5602	Coolant Filter.....	WC-56010
		Hydraulic Oil Filter.....	H-5611	Fuel Filter.....	FC-5602
		Hydraulic Oil Filter.....	H-5609	Hydraulic Oil Filter.....	H-5609
		Oil Filter Full Flow.....	C-5701	Oil Filter Full Flow.....	C-5701
		Oil Filter Full Flow.....	C-5605	Oil Filter Full Flow.....	C-5715
		Oil Filter Full Flow.....	C-5715	Oil Filter By Pass.....	O-5704
				Oil Filter Full Flow.....	C-5605
<b>HD1500-7</b> (DUMP TRUCKS) SDA12V160				<b>HD325-2</b> (DUMP TRUCKS) CUMMINS KT-1150	
Air Filter Secondary.....	A-7902	<b>HD255-5</b> (DUMP TRUCKS) HD255-5		Fuel Filter.....	FC-5721
Fuel Filter.....	FC-57290	Fuel Filter.....	FC-5610		
		<b>HD255-5</b> (DUMP TRUCKS)		<b>HD325-2</b> (DUMP TRUCKS) KT-1150	
<b>HD180-2 / 2</b> (DUMP TRUCKS) NTO-6		Air Filter Primary.....	A-6113	Air Filter Secondary.....	A-5408
Fuel Filter.....	F-5601	Air Filter Secondary.....	A-5408	Coolant Filter.....	WC-5705
Hydraulic Oil Filter.....	H-5611	Fuel Filter.....	FC-5602	Fuel Filter.....	FC-5702
Hydraulic Oil Filter.....	H-5620	Hydraulic Oil Filter.....	H-5609	Hydraulic Oil Filter.....	H-5610
Oil Filter Full Flow.....	O-5603	Oil Filter Full Flow.....	C-5605	Hydraulic Oil Filter.....	H-56600
Oil Filter By Pass.....	O-5704	Oil Filter Full Flow.....	C-5701	Oil Filter By Pass.....	O-5704
		Oil Filter Full Flow.....	C-5701	Oil Filter Full Flow.....	C-5715
		Oil Filter Full Flow.....	C-5715		
<b>HD180-4 / 956</b> (DUMP TRUCKS) NTO-6-B				<b>HD325-2</b> (DUMP TRUCKS) CUMMINS KT-1150	
Air Filter Secondary.....	A-5408	<b>HD255-5</b> (DUMP TRUCKS) SA6D125E-2/1001		Air Filter Secondary.....	A-5408
Fuel Filter.....	FC-5602	Air Filter Primary.....	A-10134	Coolant Filter.....	WC-5705
Hydraulic Oil Filter.....	H-5611	Air Filter Primary.....	A-1013	Fuel Filter.....	FC-5702
Hydraulic Oil Filter.....	H-5620	Air Filter Secondary.....	A-5631	Hydraulic Oil Filter.....	H-5609
Oil Filter By Pass.....	O-5704	Hydraulic Oil Filter.....	H-5618	Hydraulic Oil Filter.....	H-56600
Oil Filter Full Flow.....	C-5701	Hydraulic Oil Filter.....	H-5609	Oil Filter By Pass.....	O-5704
Oil Filter Full Flow.....	C-5715	Oil Filter Full Flow.....	C-5701	Oil Filter Full Flow.....	C-5715
Oil Filter Full Flow.....	C-5605	Oil Filter Full Flow.....	C-5605		
		Oil Filter Full Flow.....	C-5715	<b>HD325-3</b> (DUMP TRUCKS) KT-1150	
<b>HD200-2</b> (DUMP TRUCKS) NTC-743				Air Filter Secondary.....	A-5408
Fuel Filter.....	FC-5606	<b>HD255-5</b> (DUMP TRUCKS) SA6D125E-2/1001		Coolant Filter.....	WC-5705
		Air Filter Primary.....	A-10134	Fuel Filter.....	FC-5702
<b>HD200-2</b> (DUMP TRUCKS) NTC-743/1774		Air Filter Primary.....	A-1013	Hydraulic Oil Filter.....	H-5609
Air Filter Secondary.....	A-5408	Air Filter Secondary.....	A-5631	Hydraulic Oil Filter.....	H-56600
Fuel Filter.....	FC-5602	Hydraulic Oil Filter.....	H-5618	Oil Filter By Pass.....	O-5704
Hydraulic Oil Filter.....	H-5611	Hydraulic Oil Filter.....	H-5609	Oil Filter Full Flow.....	C-5715
Hydraulic Oil Filter.....	H-5620	Oil Filter Full Flow.....	C-5701		
Oil Filter Full Flow.....	C-5605	Oil Filter Full Flow.....	C-5605		
Oil Filter Full Flow.....	O-5603	Oil Filter Full Flow.....	C-5715		

# Sakura Filter

# ENGINE APPLICATION

MODEL/APPLICATION	SAKURA NO	MODEL/APPLICATION	SAKURA NO	MODEL/APPLICATION	SAKURA NO
<b>KOMATSU</b>		<b>KOMATSU</b>		<b>KOMATSU</b>	
<b>HD325-3</b> (DUMP TRUCKS) KT-1150/1501		Hydraulic Oil Filter.....	H-5609	<b>HD455-1</b> (DUMP TRUCKS) VTA-1710	
Air Filter Secondary.....	A-5408	Hydraulic Oil Filter.....	H-5618	Air Filter Secondary.....	A-5610
Air Filter Primary.....	A-6113	Hydraulic Oil Filter.....	H-85680	Air Filter Primary.....	A-5614
Coolant Filter.....	WC-5705			Air Filter Secondary.....	A-5408
Fuel Filter.....	FC-5702	<b>HD375-6</b> (DUMP TRUCKS)		Air Filter Primary.....	A-6113
Hydraulic Oil Filter.....	H-5609	Air Filter Primary.....	A-5558M	Fuel Filter.....	FC-5703
Oil Filter By Pass.....	O-5704	Air Filter Secondary.....	A-5559	Fuel/Water Separator.....	SFC-5707
Oil Filter Full Flow.....	C-5715	Air Filter Set.....	A-5558M-S	Fuel/Water Separator.....	SFC-5601-02
				Oil Filter By Pass.....	C-5718
<b>HD325-5</b> (DUMP TRUCKS) S/N: 2001		<b>HD325-7R</b> (DUMP TRUCKS) KOMATSU SAA6D140E-5DR-W		Oil Filter Full Flow.....	C-5715
Air Filter Secondary.....	A-5408	Hydraulic Oil Filter.....	H-56580		
Coolant Filter.....	WC-6901			<b>HD460</b> (DUMP TRUCKS) VT-1710	
Fuel Filter.....	FC-5703	<b>HD465-5</b> (DUMP TRUCKS)		Air Filter Secondary.....	A-5610
Fuel/Water Separator.....	SFC-5707	Air Filter Secondary.....	A-6011	Coolant Filter.....	WC-6901
Hydraulic Oil Filter.....	H-5609	Air Filter Primary.....	A-6010	Fuel Filter.....	FC-5703
Oil Filter Full Flow.....	C-5605	Coolant Filter.....	WC-6901	Fuel/Water Separator.....	SFC-5707
Oil Filter Full Flow.....	C-5715	Hydraulic Oil Filter.....	H-85680	Hydraulic Oil Filter.....	H-56600
Oil Filter Full Flow.....	C-5701	Hydraulic Oil Filter.....	H-7911	Hydraulic Oil Filter.....	H-5610
		Hydraulic Oil Filter.....	H-5618	Hydraulic Oil Filter.....	H-5609
<b>HD325-6</b> (DUMP TRUCKS)		Oil Filter Full Flow.....	C-5701	Oil Filter Full Flow.....	C-5701
Coolant Filter.....	WC-56010	Oil Filter Full Flow.....	C-5605	Oil Filter Full Flow.....	C-5715
Fuel Filter.....	FC-5703	Oil Filter Full Flow.....	C-5715	Oil Filter Full Flow.....	C-5605
Fuel/Water Separator.....	SFC-5707			Oil Filter By Pass.....	O-5704
Hydraulic Oil Filter.....	H-5618	<b>HD465-5</b> (DUMP TRUCKS) SA6D170-1			
Hydraulic Oil Filter.....	H-5609	Air Filter Secondary.....	A-6011	<b>HD460-1</b> (DUMP TRUCKS) VT-1710	
Oil Filter Full Flow.....	C-5715	Air Filter Primary.....	A-6010	Coolant Filter.....	WC-5711
Oil Filter Full Flow.....	C-5701	Coolant Filter.....	WC-56010	Fuel Filter.....	FC-5703
Oil Filter Full Flow.....	C-5605	Fuel Filter.....	FC-5606	Fuel/Water Separator.....	SFC-5707
		Fuel Filter.....	FC-5602	Hydraulic Oil Filter.....	H-5610
<b>HD325-6</b> (DUMP TRUCKS) SAGD140		Hydraulic Oil Filter.....	H-5618	Hydraulic Oil Filter.....	H-56600
Air Filter Primary.....	A-1013	Hydraulic Oil Filter.....	H-5609	Oil Filter By Pass.....	O-5704
Air Filter Secondary.....	A-5631	Oil Filter Full Flow.....	C-5715	Oil Filter Full Flow.....	C-5715
Air Filter Primary.....	A-10134	Oil Filter Full Flow.....	C-5701		
Air Filter Set.....	A-1841-S	Oil Filter Full Flow.....	C-5701	<b>HD465</b> (DUMP TRUCKS)	
Air Filter Primary.....	A-6113			Air Filter Set.....	A-5629-S
Air Filter Secondary.....	A-5408	<b>HD405</b> (DUMP TRUCKS)		Air Filter Primary.....	A-5629
Coolant Filter.....	WC-56010	Coolant Filter.....	WC-6901	Air Filter Secondary.....	A-5630
Fuel Filter.....	FC-5703	Fuel/Water Separator.....	SFC-5601-02	Fuel Filter.....	FC-5602
Fuel/Water Separator.....	SFC-5707			Oil Filter Full Flow.....	C-5715
Hydraulic Oil Filter.....	H-5609	<b>HD405-6</b> (DUMP TRUCKS) SAA6D140E		Oil Filter Full Flow.....	C-5701
Hydraulic Oil Filter.....	H-5618	Air Filter Primary.....	A-10134	Oil Filter Full Flow.....	C-5605
Oil Filter Full Flow.....	C-5715	Air Filter Primary.....	A-1013		
Oil Filter Full Flow.....	C-5605	Air Filter Secondary.....	A-5631	<b>HD465</b> (DUMP TRUCKS) SAA6D170E	
Oil Filter Full Flow.....	C-5701	Air Filter Set.....	A-1841-S	Fuel Filter.....	FC-5602
		Coolant Filter.....	WC-56010	Oil Filter Full Flow.....	C-5731
<b>HD325-7</b> (DUMP TRUCKS) KOMATSU SAA6D140E-3		Fuel Filter.....	FC-5703	Oil Filter By Pass.....	C-5718
Hydraulic Oil Filter.....	H-56580	Fuel/Water Separator.....	SFC-5707	Oil Filter Full Flow.....	C-7005
		Hydraulic Oil Filter.....	H-5609		
<b>HD325-7</b> (DUMP TRUCKS) KOMATSU SAA6D140E-5D-01		Oil Filter Full Flow.....	C-5715	<b>HD465-7</b> (DUMP TRUCKS) KOMATSU SAA6D170E-5	
Hydraulic Oil Filter.....	H-56580	Oil Filter Full Flow.....	C-5701	Fuel Filter.....	F-56050
		Oil Filter Full Flow.....	C-5605		
<b>HD325-7</b> (DUMP TRUCKS) SAA6D140E-5		<b>HD405-7</b> (DUMP TRUCKS) S/N: 7365 , 2008		<b>HD465-7</b> (DUMP TRUCKS) SAA6D170E	
Air Filter Primary.....	A-5558M	Air Filter Primary.....	A-5558M	Air Filter Primary.....	A-8665M
Air Filter Secondary.....	A-5559	Air Filter Secondary.....	A-5559	Air Filter Secondary.....	A-8580
Air Filter Set.....	A-5558M-S	Air Filter Set.....	A-5558M-S	Coolant Filter.....	WC-56010
Fuel/Water Separator Secondary..	SFC-5611-10	Coolant Filter.....	WC-56010	Hydraulic Oil Filter.....	H-85680
Fuel/Water Separator Secondary..	SFC-5611-10B			Hydraulic Oil Filter.....	H-5618

MODEL/APPLICATION	SAKURA NO	MODEL/APPLICATION	SAKURA NO	MODEL/APPLICATION	SAKURA NO
<b>KOMATSU</b>		<b>KOMATSU</b>		<b>KOMATSU</b>	
<b>HD465-7</b> (DUMP TRUCKS) SAA6D170E		Air Filter Primary.....	A-6010	Fuel Filter.....	FC-5703
Oil Filter Full Flow.....	C-5701	Air Filter Secondary.....	A-6011	Fuel/Water Separator.....	SFC-5707
Oil Filter Full Flow.....	C-5605	Cabin Air Filter.....	CA-5676	Hydraulic Oil Filter.....	H-7911
Oil Filter Full Flow.....	C-5715	Fuel Filter.....	FC-5602	Hydraulic Oil Filter.....	H-85680
<b>HD465-7E0</b> (DUMP TRUCKS) SAA6D170E-5		Fuel/Water Separator.....	SFC-5601-02	Hydraulic Oil Filter.....	H-5609
Air Filter Secondary.....	A-8580	Hydraulic Oil Filter.....	H-85680	Oil Filter By Pass.....	C-5718
Air Filter Primary.....	A-8665M	Hydraulic Oil Filter.....	H-7911	Oil Filter Full Flow.....	C-5701
Coolant Filter.....	WC-56010	Oil Filter By Pass.....	C-5718	Oil Filter Full Flow.....	C-5715
Fuel/Water Separator Secondary..	SFC-5611-10	Oil Filter Full Flow.....	C-5701	Oil Filter Full Flow.....	C-5605
Fuel/Water Separator Secondary..	SFC-5611-10B	Oil Filter Full Flow.....	C-5715	Oil Filter By Pass.....	O-5704
Hydraulic Oil Filter.....	H-85680	Oil Filter Full Flow.....	C-5605		
Hydraulic Oil Filter.....	H-5618			<b>HD785-1</b> (DUMP TRUCKS) KTA-2300	
<b>HD465-7R</b> (DUMP TRUCKS) KOMATSU SAA6D170E-5BR-W		<b>HD605-7E0</b> (DUMP TRUCKS) SAA6D170E-5		Air Filter Set.....	A-5629-S
Hydraulic Oil Filter.....	H-56580	Air Filter Secondary.....	A-8580	Air Filter Primary.....	A-5629
<b>HD605</b> (DUMP TRUCKS)		Air Filter Primary.....	A-8665M	Air Filter Secondary.....	A-5630
Coolant Filter.....	WC-56010	Coolant Filter.....	WC-56010	Coolant Filter.....	WC-5705
Fuel Filter.....	FC-5602	Hydraulic Oil Filter.....	H-85680	Fuel Filter.....	FC-5703
Oil Filter Full Flow.....	C-5605	Hydraulic Oil Filter.....	H-5618	Fuel/Water Separator.....	SFC-5707
Oil Filter Full Flow.....	C-5701			Hydraulic Oil Filter.....	H-7911
Oil Filter By Pass.....	C-5718	<b>HD680-2</b> (DUMP TRUCKS) VTA-1710		Hydraulic Oil Filter.....	H-85680
Oil Filter Full Flow.....	C-5715	Air Filter Secondary.....	A-5610	Hydraulic Oil Filter.....	H-5609
<b>HD605-5</b> (DUMP TRUCKS) KOMATSU SAA6D170E		Air Filter Primary.....	A-5614	Oil Filter Full Flow.....	C-5605
Hydraulic Oil Filter.....	H-56740	Coolant Filter.....	WC-5711	Oil Filter Full Flow.....	C-5701
<b>HD605-5</b> (DUMP TRUCKS) SA6D170E		Fuel Filter.....	FC-5703	Oil Filter Full Flow.....	C-5715
Air Filter Primary.....	A-6010	Fuel/Water Separator.....	SFC-5707	Oil Filter By Pass.....	O-5704
Air Filter Secondary.....	A-6011	Oil Filter By Pass.....	O-5704	Oil Filter By Pass.....	C-5718
Coolant Filter.....	WC-56010	Oil Filter Full Flow.....	C-5715		
Fuel Filter.....	FC-5602			<b>HD785-2</b> (DUMP TRUCKS) SA8V1710	
Hydraulic Oil Filter.....	H-85680	<b>HD785-7</b> (DUMP TRUCKS) KOMATSU SAA12V140E-3 , 2007		Air Filter Primary.....	A-5629
Hydraulic Oil Filter.....	H-7911	Air Filter Secondary.....	A-8580	Air Filter Secondary.....	A-5630
Oil Filter Full Flow.....	C-5605	Air Filter Primary.....	A-8665M	Air Filter Set.....	A-5629-S
Oil Filter Full Flow.....	C-5701	Cabin Air Filter.....	CA-5676	Fuel Filter.....	FC-5703
Oil Filter By Pass.....	C-5718	Coolant Filter.....	WC-56010	Fuel/Water Separator.....	SFC-5707
Oil Filter Full Flow.....	C-5715	Fuel/Water Separator Secondary..	SFC-5611-10	Hydraulic Oil Filter.....	H-7911
<b>HD605-5</b> (DUMP TRUCKS) SAA6D170E		Fuel/Water Separator Secondary..	SFC-5611-10B	Hydraulic Oil Filter.....	H-5609
Air Filter Secondary.....	A-6011	Hydraulic Oil Filter.....	H-85680	Hydraulic Oil Filter.....	H-85680
Air Filter Primary.....	A-6010	Hydraulic Oil Filter.....	H-5618	Oil Filter Full Flow.....	C-5701
Coolant Filter.....	WC-56010			Oil Filter Full Flow.....	C-5715
Fuel Filter.....	FC-5602	<b>HD785-7</b> (DUMP TRUCKS) KOMATSU SAA12V140E-3B-02		Oil Filter Full Flow.....	C-5605
Hydraulic Oil Filter.....	H-7911	Hydraulic Oil Filter.....	H-56580		
Hydraulic Oil Filter.....	H-85680			<b>HD785-3</b> (DUMP TRUCKS) SA12V140	
Oil Filter Full Flow.....	C-5701	<b>HD785</b> (DUMP TRUCKS) KTA-2300		Air Filter Primary.....	A-6010
Oil Filter By Pass.....	C-5718	Air Filter Set.....	A-5629-S	Air Filter Secondary.....	A-6011
Oil Filter Full Flow.....	C-5715	Air Filter Primary.....	A-5629	Coolant Filter.....	WC-56010
Oil Filter Full Flow.....	C-5605	Air Filter Secondary.....	A-5630	Fuel Filter.....	FC-5703
<b>HD605-7</b> (DUMP TRUCKS) KOMATSU SAA6D170E-3F-8		Coolant Filter.....	WC-5711	Fuel/Water Separator.....	SFC-5707
Hydraulic Oil Filter.....	H-56580	Coolant Filter.....	WC-5705	Hydraulic Oil Filter.....	H-7911
<b>HD605-7</b> (DUMP TRUCKS) SAA6D170E		Fuel Filter.....	FC-5703	Hydraulic Oil Filter.....	H-5618
Air Filter Secondary.....	A-6011	Fuel/Water Separator.....	SFC-5707	Hydraulic Oil Filter.....	H-85680
Air Filter Primary.....	A-6010	Hydraulic Oil Filter.....	H-5606	Oil Filter Full Flow.....	C-5701
Coolant Filter.....	WC-56010	Oil Filter By Pass.....	C-5718	Oil Filter By Pass.....	C-5718
Fuel Filter.....	FC-5602	Oil Filter Full Flow.....	C-5715	Oil Filter Full Flow.....	C-5715
Hydraulic Oil Filter.....	H-7911			Oil Filter Full Flow.....	C-5605
Hydraulic Oil Filter.....	H-85680	<b>HD785-1</b> (DUMP TRUCKS) KT2300			
Oil Filter Full Flow.....	C-5701	Air Filter Primary.....	A-5629	<b>HD785-5</b> (DUMP TRUCKS) SA12V140	
Oil Filter By Pass.....	C-5718	Air Filter Secondary.....	A-5630	Air Filter Secondary.....	A-6011
Oil Filter Full Flow.....	C-5715	Air Filter Set.....	A-5629-S	Air Filter Primary.....	A-6010
Oil Filter Full Flow.....	C-5605	Coolant Filter.....	WC-5705	Coolant Filter.....	WC-56010
<b>HD605-7</b> (DUMP TRUCKS) KOMATSU SAA6D170E-3F-8		Oil Filter Full Flow.....	C-5715	Fuel Filter.....	FC-5703
Hydraulic Oil Filter.....	H-56580				
<b>HD605-7</b> (DUMP TRUCKS) SAA6D170E					



# Sakura Filter

# ENGINE APPLICATION

MODEL/APPLICATION	SAKURA NO	MODEL/APPLICATION	SAKURA NO	MODEL/APPLICATION	SAKURA NO
<b>KOMATSU</b>		<b>KOMATSU</b>		<b>KOMATSU</b>	
<b>HD785-5</b> (DUMP TRUCKS) SA12V140		Cabin Air Filter Set.....	CA-5601-S	Hydraulic Oil Filter.....	H-56580
Fuel/Water Separator.....	SFC-5707	Fuel/Water Separator Secondary...	SFC-5611-10	<b>HM300-1</b> (ARTICULATED TRUCKS) KOMATSU SAA6D140E-3H-8	
Hydraulic Oil Filter.....	H-7911	Fuel/Water Separator Secondary..	SFC-5611-10B	Fuel Filter.....	FC-5612
Hydraulic Oil Filter.....	H-85680	Hydraulic Oil Filter.....	H-85680	<b>HM300-1</b> (ARTICULATED TRUCKS) KOMATSU SAA6D140E-3J-8	
Hydraulic Oil Filter.....	H-5618	Hydraulic Oil Filter.....	H-5609	Fuel Filter.....	FC-5612
Oil Filter Full Flow.....	C-5701	<b>HM350</b> (ARTICULATED TRUCKS) KOMATSU SAA6D140E		<b>HM300-1</b> (ARTICULATED TRUCKS) KOMATSU SAA6D125E-3G-8M	
Oil Filter By Pass.....	C-5718	Fuel Filter.....	FC-5622	Fuel Filter.....	FC-5612
Oil Filter Full Flow.....	C-5605	<b>HM350</b> (ARTICULATED TRUCKS) SAA6D140E		<b>HM300-1</b> (ARTICULATED TRUCKS) KOMATSU SAA6D125E-3G-8M	
Oil Filter Full Flow.....	C-5715	Air Filter Secondary.....	A-8580	Fuel Filter.....	FC-5612
<b>HD7855LC</b> (DUMP TRUCKS) SAA12V140ZE-2 , 2011		Air Filter Primary.....	A-8665M	<b>HM300-1</b> (ARTICULATED TRUCKS) SAA6D125E	
Air Filter Primary.....	A-6010	Cabin Air Filter Set.....	CA-5601-S	Air Filter Secondary.....	A-8580
Air Filter Secondary.....	A-6011	Fuel/Water Separator.....	SFC-5601-02	Air Filter Primary.....	A-8665M
Coolant Filter.....	WC-5713	Hydraulic Oil Filter.....	H-85680	Hydraulic Oil Filter.....	H-5609
Fuel Filter.....	FC-5703	<b>HM350</b> (ARTICULATED TRUCKS) SAA6D140E-2		Oil Filter Full Flow.....	C-5715
Fuel/Water Separator.....	SFC-5707	Coolant Filter.....	WC-5708	Oil Filter Full Flow.....	C-5605
Hydraulic Oil Filter.....	H-7911	<b>HM350-1</b> (ARTICULATED TRUCKS) KOMATSU SAA6D140E-3H-8		Oil Filter Full Flow.....	C-5701
Hydraulic Oil Filter.....	H-85680	Hydraulic Oil Filter.....	H-56580	<b>HM300-3</b> (ARTICULATED TRUCKS) SAA6D125E-6 , 2012	
Oil Filter Full Flow.....	C-5715	<b>HM350-1</b> (ARTICULATED TRUCKS) KOMATSU SAA6D140E-3J-8		Air Filter Secondary.....	A-8580
<b>HD7855LC</b> (DUMP TRUCKS) QST30 SERIES		Hydraulic Oil Filter.....	H-56580	Air Filter Primary.....	A-8665M
Air Filter Secondary.....	A-6011	<b>HM350-1</b> (ARTICULATED TRUCKS) KOMATSU SAA6D140E-3H-8		Cabin Air Filter.....	CA-5676
Air Filter Primary.....	A-6010	Hydraulic Oil Filter.....	H-56580	Hydraulic Oil Filter.....	H-5646
Fuel/Water Separator.....	SFC-5601-02	<b>HM350-1</b> (ARTICULATED TRUCKS) SAA6D140E		Hydraulic Oil Filter.....	H-5629
Oil Filter Full Flow.....	C-57430	Air Filter Secondary.....	A-8580	<b>HM400-2</b> (ARTICULATED TRUCKS) SAA6D140E-5 , 2006	
<b>HD985-3</b> (DUMP TRUCKS) SA12V140-1		Air Filter Primary.....	A-8665M	Cabin Air Filter.....	CA-5676
Air Filter Secondary.....	A-6011	Cabin Air Filter Set.....	CA-5601-S	Cabin Air Filter.....	CA-5602
Air Filter Primary.....	A-6010	Cabin Air Filter.....	CA-56100	Fuel/Water Separator Secondary..	SFC-5611-10
Coolant Filter.....	WC-6901	Fuel/Water Separator.....	SFC-5601-02	Fuel/Water Separator Secondary..	SFC-5611-10B
Fuel Filter.....	FC-5703	Hydraulic Oil Filter.....	H-85680	Hydraulic Oil Filter.....	H-85680
Fuel/Water Separator.....	SFC-5707	<b>HM350-1</b> (ARTICULATED TRUCKS) SAA6D140E-3		<b>HM400-2</b> (ARTICULATED TRUCKS) KOMATSU SAA6D140E-5C-01	
Hydraulic Oil Filter.....	H-7911	Coolant Filter.....	WC-5708	Hydraulic Oil Filter.....	H-56580
Hydraulic Oil Filter.....	H-85680	Fuel/Water Separator.....	SFC-5601-02	<b>HM400-1</b> (ARTICULATED TRUCKS) SAA6D140E-3 , 2008	
Hydraulic Oil Filter.....	H-5618	<b>HM300-2</b> (ARTICULATED TRUCKS) SAA6D125E-5 , 2006		Cabin Air Filter.....	CA-56100
Oil Filter Full Flow.....	C-5605	Cabin Air Filter.....	CA-5676	Fuel/Water Separator Secondary..	SFC-5611-10
Oil Filter Full Flow.....	C-5701	Cabin Air Filter.....	CA-5602	Fuel/Water Separator Secondary..	SFC-5611-10B
Oil Filter Full Flow.....	C-5715	Fuel/Water Separator Secondary..	SFC-5611-10B	Hydraulic Oil Filter.....	H-85680
Oil Filter By Pass.....	C-5718	Fuel/Water Separator Secondary..	SFC-5611-10	<b>HM400-1</b> (ARTICULATED TRUCKS) KOMATSU SAA6D140E-3B-8	
<b>HF</b> (LOADERS) D-2300		Hydraulic Oil Filter.....	H-5609	Hydraulic Oil Filter.....	H-56580
Fuel Filter.....	FC-5103	Hydraulic Oil Filter.....	H-85680	<b>HM400-3</b> (ARTICULATED TRUCKS) SAA6D140E-6 , 2012	
<b>HFC</b> (LOADERS) D-2300		<b>HM300-2</b> (ARTICULATED TRUCKS) KOMATSU SAA6D125E-5B-02		Air Filter Secondary.....	A-8580
Fuel Filter.....	FC-5103	Hydraulic Oil Filter.....	H-56580	Air Filter Primary.....	A-8665M
<b>HFH</b> (LOADERS) D-2300		<b>HM350-2</b> (ARTICULATED TRUCKS) SAA6D140E-5 , 2006		Hydraulic Oil Filter.....	H-5629
Fuel Filter.....	FC-5103	Cabin Air Filter.....	CA-5676	Hydraulic Oil Filter.....	H-5646
<b>HH</b> (LOADERS) DJXH		Cabin Air Filter.....	CA-5602	<b>HM400-3</b> (ARTICULATED TRUCKS) SAA6D140E-5/STAGE IIIB/TIER 4 , 2012	
Hydraulic Oil Filter Transmission...	H-65030	Fuel/Water Separator Secondary... SFC-5611-10		Air Filter Primary.....	A-8665M
<b>HM300</b> (ARTICULATED TRUCKS)		Fuel/Water Separator Secondary.. SFC-5611-10B		Air Filter Secondary.....	A-8580
Air Filter Secondary.....	A-8580	Hydraulic Oil Filter.....	H-85680	Hydraulic Oil Filter.....	H-5629
Air Filter Primary.....	A-8665M	<b>HM350-2</b> (ARTICULATED TRUCKS) KOMATSU SAA6D140E-5E-01		Hydraulic Oil Filter.....	H-5646
Cabin Air Filter.....	CA-56100				

# Sakura Filter

# ENGINE APPLICATION

MODEL/APPLICATION	SAKURA NO	MODEL/APPLICATION	SAKURA NO	MODEL/APPLICATION	SAKURA NO
<b>KOMATSU</b>		<b>KOMATSU</b>		<b>KOMATSU</b>	
HM400-2R (DUMP TRUCKS) KOMATSU SAA6D140E-5CR-W Hydraulic Oil Filter.....	H-56580	JH80B (LOADERS) DT466 Fuel/Water Separator.....	SFC-5705	Air Filter Secondary.....	A-5606
HO (LOADERS) WXL3-3 Hydraulic Oil Filter Transmission...	H-65030	JH80C (LOADERS) PD6T04 Fuel Filter.....	F-1801	Air Filter Set.....	A-5604-S
IHC DROTT 150 (LOADERS) Hydraulic Oil Filter Transmission...	H-65030	Hydraulic Oil Filter.....	H-5618	Air Filter Primary.....	A-5605
JH30B (LOADERS) DA220 Air Filter.....	AS-1010	Oil Filter By Pass.....	O-18051	Hydraulic Oil Filter.....	H-5611
Fuel Filter.....	F-1303	Oil Filter Combination.....	O-1809	Oil Filter Full Flow.....	C-5614
JH63 (LOADERS) DA220 Fuel Filter.....	F-1303	JH90E (LOADERS) 6D95L Fuel Filter.....	F-1303	<b>L100 (LOADERS) 6V-71</b> Fuel Filter.....	F-7302
JH63-2 (LOADERS) 6B155 Air Filter Secondary.....	A-6009	JH90E (LOADERS) V170 Fuel Filter.....	F-1303	Fuel Filter.....	F-6503
Air Filter Primary.....	AS-1024	JH90EA (LOADERS) 6D95L Fuel Filter.....	F-1303	Fuel Filter.....	F-6505
Air Filter Set.....	AS-1024-S	JH90EA (LOADERS) V170 Fuel Filter.....	F-1303	Fuel Filter.....	F-6504
Coolant Filter.....	WC-5707	JH90EH (LOADERS) DVT-573B Fuel Filter Secondary.....	FC-54050	Oil Filter Full Flow.....	O-6503
Oil Filter Full Flow.....	C-5614	Fuel Filter.....	FC-7933	<b>L100 (LOADERS) IHC</b> Fuel Filter Secondary.....	FC-54050
JH65C (LOADERS) DA640 Air Filter Primary.....	A-5413	Fuel/Water Separator.....	SFC-5705	Fuel/Water Separator.....	SFC-5705
Air Filter Set.....	A-5660-S	Oil Filter Full Flow.....	C-5402	Hydraulic Oil Filter Transmission...	H-65030
Air Filter Secondary.....	A-7608	JH90EV (LOADERS) V-903 Coolant Filter.....	WC-5705	Oil Filter Full Flow.....	C-5402
Fuel Filter.....	F-1303	Fuel Filter.....	F-5701	<b>L100 (LOADERS) NH220</b> Fuel Filter.....	F-5701
JH65C-2 (LOADERS) DA640 Air Filter Secondary.....	A-7608	Oil Filter Full Flow.....	O-5603	Hydraulic Oil Filter Transmission...	H-65030
Fuel Filter.....	F-1303	Oil Filter By Pass.....	O-5704	Oil Filter Full Flow.....	O-5702
JH65CH (LOADERS) DT414 Fuel/Water Separator.....	SFC-5705	JV100-1 (COMPACTORS) Air Filter Primary.....	A-5605	<b>L100 (LOADERS) NH250</b> Fuel Filter.....	F-5701
JH65CN (LOADERS) C464 Air Filter Set.....	A-5660-S	Air Filter Secondary.....	A-5606	Hydraulic Oil Filter Transmission...	H-65030
Air Filter Primary.....	A-5413	Air Filter Set.....	A-5604-S	Oil Filter Full Flow.....	O-5702
Air Filter Secondary.....	A-7608	Hydraulic Oil Filter.....	H-5611	<b>L100 (LOADERS) NT-855</b> Air Filter.....	AS-5706
Fuel Filter.....	F-5701	Oil Filter Full Flow.....	C-5614	Fuel Filter.....	FC-5720
Oil Filter By Pass.....	O-5704	JV100A-1 (COMPACTORS) S6D105 Air Filter Primary.....	A-5605	Fuel Filter.....	FC-5701
Oil Filter Full Flow.....	O-5702	Air Filter Set.....	A-5604-S	Fuel Filter.....	FC-1303
JH65CV (LOADERS) CUMMINS V-504 Fuel Filter.....	FC-5721	Air Filter Secondary.....	A-5606	Fuel/Water Separator.....	SFC-5705
JH65CV (LOADERS) V-504 Air Filter Secondary.....	A-7608	Hydraulic Oil Filter.....	H-5611	Hydraulic Oil Filter Transmission...	H-65030
Coolant Filter.....	WC-5711	Oil Filter Full Flow.....	C-5614	Oil Filter Full Flow.....	O-5702
Fuel Filter.....	FC-5720	JV100WA-1 (COMPACTORS) S6D105 Air Filter Primary.....	A-5605	<b>L-100 SERIES E (LOADERS)</b> Fuel Filter.....	FC-5715
Fuel/Water Separator.....	SFC-5705	Air Filter Secondary.....	A-5606	Fuel Filter.....	FC-5103
Oil Filter Full Flow.....	O-5703	Air Filter Set.....	A-5604-S	Oil Filter Full Flow.....	C-1807
Oil Filter By Pass.....	O-5704	Hydraulic Oil Filter.....	H-5611	<b>L120 (LOADERS) 8V-71</b> Fuel Filter.....	F-7302
JV100WP-1 (COMPACTORS) S6D105		Oil Filter Full Flow.....	C-5614	Fuel Filter.....	F-6503
		<b>L-150 (LOADERS)</b> Hydraulic Oil Filter Transmission...	H-65030	Oil Filter Full Flow.....	O-6503
		<b>L-150 (LOADERS) UD282F6</b>			

MODEL/APPLICATION	SAKURA NO	MODEL/APPLICATION	SAKURA NO	MODEL/APPLICATION	SAKURA NO
<b>KOMATSU</b>		<b>KOMATSU</b>		<b>KOMATSU</b>	
<b>L-150</b> (LOADERS) UD282F6		Air Filter Primary.....	A-5605	<b>PC02-1</b> (EXCAVATORS) 2D92/11701-UP	
Hydraulic Oil Filter Transmission...	H-65030	Air Filter Secondary.....	A-5606	Air Filter.....	A-52180
<b>L-165</b> (LOADERS) D310		Fuel Filter.....	FC-5602	Hydraulic Oil Filter.....	H-5608
Fuel Filter.....	FC-5715	Hydraulic Oil Filter.....	H-85680	Oil Filter Full Flow.....	C-5606
Fuel Filter.....	FC-5103	Hydraulic Oil Filter.....	H-7911	Oil Filter Full Flow.....	C-5604
Fuel Filter.....	F-2604	Oil Filter Full Flow.....	C-5605		
<b>L-175E</b> (LOADERS)		Oil Filter Full Flow.....	C-5701	<b>PC03</b> (EXCAVATORS) KOMATSU	
Air Filter Secondary.....	A-5414	Oil Filter Full Flow.....	C-5715	Fuel Filter.....	F-5207
Air Filter Set.....	A-5660-S	<b>MC280</b> (CRANES) F6/8L413		Oil Filter Full Flow.....	C-5205
Air Filter Primary.....	A-5413	Fuel Filter.....	F-2603	<b>PC03-1</b> (EXCAVATORS) 1D84-1B/10001	
Fuel Filter.....	FC-1810	Fuel Filter.....	FC-5704	Air Filter.....	A-52180
Fuel Filter.....	FC-7933	Oil Filter Full Flow.....	C-6204	<b>PC03-1</b> (EXCAVATORS) 1D84-1A/10001	
Hydraulic Oil Filter.....	H-5406	Oil Filter Full Flow.....	C-6203	Air Filter.....	A-52180
<b>L-700</b> (LOADERS)		<b>MC500</b> (CRANES) F6/8L413		<b>PC03-2</b> (EXCAVATORS) 1D84-1C/15001	
Air Filter Set.....	A-9217-S	Fuel Filter.....	FC-5704	Air Filter.....	A-52180
Air Filter Primary.....	A-9217	Fuel Filter.....	F-2603	Fuel Filter.....	F-5207
Air Filter Secondary.....	A-7902	Oil Filter Full Flow.....	C-6204		
Coolant Filter.....	WC-5707	Oil Filter Full Flow.....	C-6203	<b>PC04</b> (EXCAVATORS) 2D94-2	
Fuel Filter.....	FC-5720	<b>P37</b> (EXCAVATORS)		Air Filter Primary.....	AS-1014
Fuel/Water Separator.....	SFC-5705	Air Filter Set.....	A-5675-S	Hydraulic Oil Filter.....	H-5607
Oil Filter By Pass.....	O-5704	Air Filter Secondary.....	A-5674	Hydraulic Oil Filter.....	H-5608
Oil Filter Full Flow.....	C-5715	Air Filter Primary.....	A-5673	Oil Filter Full Flow.....	C-5606
<b>LOADSTER 1600</b> (LOADERS)		Air Filter Secondary.....	A-8670		
Fuel Filter.....	FC-5103	Fuel Filter Secondary.....	FC-7903	<b>PC04</b> (EXCAVATORS) 2D94	
Oil Filter Full Flow.....	O-1902	Fuel/Water Separator.....	SFC-5708	Hydraulic Oil Filter.....	H-5607
<b>LOADSTER 1700</b> (LOADERS)		<b>P8</b> (DOZERS) S/N: 45001		Hydraulic Oil Filter.....	H-5608
Fuel Filter.....	FC-5103	Air Filter Set.....	A-5604-S	Oil Filter Full Flow.....	C-5606
Oil Filter Full Flow.....	O-1902	Air Filter Secondary.....	A-5606	<b>PC04-1</b> (EXCAVATORS) 2D92	
<b>LOADSTER 1800</b> (LOADERS)		Air Filter Primary.....	A-5605	Hydraulic Oil Filter.....	H-5607
Fuel Filter.....	FC-5103	Fuel Filter.....	FC-5602	Hydraulic Oil Filter.....	H-5608
Oil Filter Full Flow.....	O-1902	Hydraulic Oil Filter.....	H-5601		
<b>LW160-1</b> (CRANES) S/N: 1004		Hydraulic Oil Filter.....	H-5620	<b>PC04-1</b> (EXCAVATORS) 2D94	
Air Filter Secondary.....	A-5408	Oil Filter Full Flow.....	C-5614	Air Filter Primary.....	AS-1014
Coolant Filter.....	WC-5707	<b>PC01-1</b> (EXCAVATORS) GX160K1-SKM1		Hydraulic Oil Filter.....	H-5607
Hydraulic Oil Filter.....	H-5607	Fuel Filter.....	F-5202	Hydraulic Oil Filter.....	H-5608
Hydraulic Oil Filter.....	H-7911	<b>PC02-1</b> (EXCAVATORS) 1D75-1A/10001		Oil Filter Full Flow.....	C-5606
Hydraulic Oil Filter.....	H-85680	Air Filter.....	A-5206	<b>PC05</b> (EXCAVATORS)	
Oil Filter Full Flow.....	C-5614	<b>PC02-1</b> (EXCAVATORS) 1D75-1B/10001		Air Filter.....	AS-5412
<b>LW200L-1</b> (CRANES) S/N: 1001		Air Filter.....	A-5206	Fuel Filter.....	F-5207
Air Filter Secondary.....	A-5408	<b>PC02-1</b> (EXCAVATORS) 2D92		Oil Filter Full Flow.....	C-1920
Coolant Filter.....	WC-5707	Oil Filter Full Flow.....	C-5615	<b>PC05-1</b> (EXCAVATORS) 3D72-1	
Hydraulic Oil Filter.....	H-7911	Oil Filter Full Flow.....	C-5616	Air Filter.....	AS-5412
Hydraulic Oil Filter.....	H-85680	<b>PC02-1</b> (EXCAVATORS) 2D94		Fuel Filter.....	F-5207
Hydraulic Oil Filter.....	H-5607	Hydraulic Oil Filter.....	H-5608	Oil Filter Full Flow.....	C-1920
Oil Filter Full Flow.....	C-5614	Oil Filter Full Flow.....	C-5616	<b>PC05-1</b> (EXCAVATORS)	
<b>LW250L-1</b> (CRANES) S/N: 1001		Oil Filter Full Flow.....	C-5606	Air Filter.....	AS-5412
Air Filter Set.....	A-5604-S	Oil Filter Full Flow.....	C-5615	Fuel Filter.....	F-5207
				Oil Filter Full Flow.....	C-1920

MODEL/APPLICATION	SAKURA NO	MODEL/APPLICATION	SAKURA NO	MODEL/APPLICATION	SAKURA NO
<b>KOMATSU</b>		<b>KOMATSU</b>		<b>KOMATSU</b>	
<b>PC05-1 W</b> (EXCAVATORS)		Air Filter.....	AS-5412	Fuel Filter.....	FC-5606
Air Filter.....	AS-5412	Fuel Filter.....	F-5207	<b>PC1000-1</b> (EXCAVATORS) SA6D170B-1/10001	
Fuel Filter.....	F-5207	Fuel Filter.....	F-5214	Air Filter Secondary.....	A-5610
Oil Filter Full Flow.....	C-1920	<b>PC07-2</b> (EXCAVATORS)		Air Filter Primary.....	A-5614
<b>PC05-5</b> (EXCAVATORS) 3D72-2/2501		Air Filter.....	AS-5412	Coolant Filter.....	WC-56010
Air Filter Primary.....	AS-8801	Fuel Filter.....	F-5207	Fuel Filter.....	FC-5602
Fuel Filter.....	F-5207	<b>PC09</b> (EXCAVATORS) KOMATSU		Hydraulic Oil Filter.....	H-7911
<b>PC05-5</b> (EXCAVATORS) 3D72-2/2501/00101		Fuel Filter.....	F-5207	Hydraulic Oil Filter Return.....	HC-5603
Air Filter Primary.....	AS-8801	Oil Filter Full Flow.....	C-5205	Hydraulic Oil Filter.....	H-85680
Fuel Filter.....	F-5207	<b>PC09-1</b> (EXCAVATORS) 2D70E		Oil Filter Full Flow.....	C-5605
<b>PC05-6</b> (EXCAVATORS) 3D72-2/11701/02519		Air Filter Primary.....	A-8504	Oil Filter Full Flow.....	C-5701
Fuel Filter.....	F-5207	Fuel Filter.....	F-5207	Oil Filter Full Flow.....	C-5715
<b>PC05-6</b> (EXCAVATORS) 3D72-2/11701		<b>PC100</b> (EXCAVATORS) 6D95L		<b>PC1000-1</b> (EXCAVATORS) SA6D170B-1/10001/11763	
Fuel Filter.....	F-5207	Air Filter Primary.....	AS-7805	Air Filter Primary.....	A-5614
<b>PC05-6</b> (EXCAVATORS) 3D72-2/2519/11701		Air Filter Secondary.....	A-7806	Air Filter Secondary.....	A-5610
Fuel Filter.....	F-5207	Coolant Filter.....	WC-5707	Coolant Filter.....	WC-6901
<b>PC05-6F</b> (EXCAVATORS)		Fuel Filter.....	FC-5604	Fuel Filter.....	FC-5602
Fuel Filter.....	FC-1801	Hydraulic Oil Filter.....	H-5610	Hydraulic Oil Filter.....	H-85680
<b>PC05-7</b> (EXCAVATORS) 3D68E-3/10617		Hydraulic Oil Filter.....	H-56600	Hydraulic Oil Filter Return.....	HC-5603
Air Filter.....	AS-5412	Oil Filter Full Flow.....	C-5405	Hydraulic Oil Filter.....	H-7911
Fuel Filter.....	F-5207	<b>PC100</b> (EXCAVATORS) S4D105-5		Oil Filter Full Flow.....	C-5605
Oil Filter Full Flow.....	C-5205	Air Filter Primary.....	AS-1024	Oil Filter Full Flow.....	C-5701
Oil Filter Full Flow.....	C-5708	Air Filter Set.....	AS-1024-S	Oil Filter Full Flow.....	C-5715
<b>PC05-7</b> (EXCAVATORS) 3D68E-3/5001/6221		Air Filter Secondary.....	A-6009	<b>PC1000LC-1</b> (EXCAVATORS) S6D170-1/10001	
Air Filter.....	AS-5412	Fuel Filter.....	FC-5604	Air Filter Secondary.....	A-5610
Fuel Filter.....	F-5207	Hydraulic Oil Filter.....	H-56600	Air Filter Primary.....	A-5614
Oil Filter Full Flow.....	C-5708	Hydraulic Oil Filter.....	H-5610	Coolant Filter.....	WC-6901
Oil Filter Full Flow.....	C-5205	Oil Filter Full Flow.....	C-5614	Fuel Filter.....	FC-5602
<b>PC05-7</b> (EXCAVATORS) 3D68E-3/8001		<b>PC100</b> (EXCAVATORS) S4D105		Hydraulic Oil Filter.....	H-7911
Air Filter.....	AS-5412	Air Filter Primary.....	AS-1024	Hydraulic Oil Filter Return.....	HC-5603
Fuel Filter.....	F-5207	Air Filter Set.....	AS-1024-S	Oil Filter Full Flow.....	C-5605
Oil Filter Full Flow.....	C-5205	Fuel Filter.....	FC-5604	Oil Filter Full Flow.....	C-5701
Oil Filter Full Flow.....	C-5708	Hydraulic Oil Filter.....	H-56600	Oil Filter Full Flow.....	C-5715
<b>PC05-7</b> (EXCAVATORS) 3D72-2/10617		Hydraulic Oil Filter.....	H-5610	<b>PC1000LC-1</b> (EXCAVATORS) SA6D170	
Air Filter.....	AS-5412	Oil Filter Full Flow.....	C-5614	Fuel Filter.....	FC-5606
Fuel Filter.....	F-5207	<b>PC1000</b> (EXCAVATORS) SA6D170		<b>PC1000LC-1</b> (EXCAVATORS) SA6D170B-1/10001	
Oil Filter Full Flow.....	C-5708	Air Filter Secondary.....	A-5610	Air Filter Secondary.....	A-5610
Oil Filter Full Flow.....	C-5205	Air Filter Primary.....	A-5614	Air Filter Primary.....	A-5614
<b>PC05-7</b> (EXCAVATORS) 3D72-2/8001/10616/8001		Coolant Filter.....	WC-6901	Coolant Filter.....	WC-56010
Fuel Filter.....	F-5207	Fuel Filter.....	FC-5602	Fuel Filter.....	FC-5602
Oil Filter Full Flow.....	C-5708	Hydraulic Oil Filter.....	H-7911	Hydraulic Oil Filter.....	H-85680
Oil Filter Full Flow.....	C-5205	Hydraulic Oil Filter.....	H-85680	Hydraulic Oil Filter Return.....	HC-5603
<b>PC05-7E</b> (EXCAVATORS)		Oil Filter Full Flow.....	C-5715	Oil Filter Full Flow.....	C-5605
Fuel Filter.....	F-5207	Oil Filter Full Flow.....	C-5605	Oil Filter Full Flow.....	C-5701
Oil Filter Full Flow.....	C-5708	Oil Filter Full Flow.....	C-5701	Oil Filter Full Flow.....	C-5715
<b>PC1000-1</b> (EXCAVATORS) SA6D170		<b>PC1000-1</b> (EXCAVATORS) SA6D170		<b>PC1000SE-1</b> (EXCAVATORS) S6D170-1/10001	
Air Filter Primary.....	A-5610	Air Filter Secondary.....	A-5610	Air Filter Secondary.....	A-5610
Air Filter Primary.....	A-5614	Air Filter Primary.....	A-5614	Air Filter Primary.....	A-5614
Coolant Filter.....	WC-6901	Coolant Filter.....	WC-6901	Coolant Filter.....	WC-6901
Fuel Filter.....	FC-5602	Fuel Filter.....	FC-5602	Fuel Filter.....	FC-5602
Hydraulic Oil Filter.....	H-7911	Hydraulic Oil Filter.....	H-7911		
Hydraulic Oil Filter Return.....	HC-5603	Hydraulic Oil Filter Return.....	HC-5603		
Oil Filter Full Flow.....	C-5605	Oil Filter Full Flow.....	C-5605		
Oil Filter Full Flow.....	C-5701	Oil Filter Full Flow.....	C-5701		
Oil Filter Full Flow.....	C-5715	Oil Filter Full Flow.....	C-5715		

MODEL/APPLICATION	SAKURA NO	MODEL/APPLICATION	SAKURA NO	MODEL/APPLICATION	SAKURA NO
<b>KOMATSU</b>		<b>KOMATSU</b>		<b>KOMATSU</b>	
<b>PC1000SE-1</b> (EXCAVATORS) S6D170-1/10001		Oil Filter Full Flow.....	C-5614	Hydraulic Oil Filter.....	H-5610
Hydraulic Oil Filter.....	H-7911	<b>PC100-3</b> (EXCAVATORS) 6D95L-1/18001		Hydraulic Oil Filter.....	H-56600
Hydraulic Oil Filter.....	H-85680	Air Filter Primary.....	AS-7805	Oil Filter Full Flow.....	C-5606
Hydraulic Oil Filter Return.....	HC-5603	Air Filter Secondary.....	A-7806	<b>PC100-6</b> (EXCAVATORS) KOMATSU S4D102E-1D	
Oil Filter Full Flow.....	C-5715	Fuel Filter.....	FC-5604	Oil Filter Full Flow.....	C-5712
Oil Filter Full Flow.....	C-5701	Hydraulic Oil Filter.....	H-56600	<b>PC100-6</b> (EXCAVATORS) KOMATSU S4D95L-1	
Oil Filter Full Flow.....	C-5605	Hydraulic Oil Filter.....	H-5610	Air Filter Secondary.....	A-5647
<b>PC1000SE-1</b> (EXCAVATORS) SAGD170		Oil Filter Full Flow.....	C-5604	<b>PC100-6</b> (EXCAVATORS) KOMATSU S4D95L-1J	
Fuel Filter.....	FC-5606	<b>PC100-3</b> (EXCAVATORS) 6D95L-1/18001/10001/20188		Air Filter Secondary.....	A-5647
<b>PC1000SE-1</b> (EXCAVATORS) SAGD170B-1/10001		Air Filter Primary.....	AS-7805	<b>PC100-6</b> (EXCAVATORS) S4D102E-1/42554	
Air Filter Primary.....	A-5614	Air Filter Secondary.....	A-7806	Air Filter Secondary.....	A-6008
Air Filter Secondary.....	A-5610	Coolant Filter.....	WC-5707	Air Filter Primary.....	A-5627
Coolant Filter.....	WC-56010	Fuel Filter.....	FC-5604	Air Filter Set.....	A-5663-S
Fuel Filter.....	FC-5602	Hydraulic Oil Filter.....	H-56600	Hydraulic Oil Filter.....	H-5610
Hydraulic Oil Filter.....	H-7911	Hydraulic Oil Filter.....	H-5610	Hydraulic Oil Filter.....	H-56600
Hydraulic Oil Filter.....	H-85680	Oil Filter Full Flow.....	C-5604	Oil Filter Full Flow.....	C-5703
Hydraulic Oil Filter Return.....	HC-5603	<b>PC100-3</b> (EXCAVATORS) 6D95L-1/18001/20188		<b>PC100-6</b> (EXCAVATORS) S4D95L	
Oil Filter Full Flow.....	C-5605	Air Filter Primary.....	AS-7805	Air Filter Primary.....	A-7939
Oil Filter Full Flow.....	C-5701	Coolant Filter.....	WC-5707	Hydraulic Oil Filter.....	H-56600
Oil Filter Full Flow.....	C-5715	Fuel Filter.....	FC-5604	Hydraulic Oil Filter.....	H-5610
<b>PC100-1</b> (EXCAVATORS) S4D105-5		Hydraulic Oil Filter.....	H-56600	Oil Filter Full Flow.....	C-5606
Air Filter Secondary.....	A-6009	Hydraulic Oil Filter.....	H-5610	<b>PC100-6</b> (EXCAVATORS) S4D95L-1/40001 - 42553	
Air Filter Primary.....	AS-1024	Oil Filter Full Flow.....	C-5604	Air Filter Primary.....	A-7939
Air Filter Set.....	AS-1024-S	<b>PC100-3SER</b> (EXCAVATORS)		Hydraulic Oil Filter.....	H-56600
Fuel Filter.....	FC-5604	Air Filter Secondary.....	A-7806	Hydraulic Oil Filter.....	H-5610
Hydraulic Oil Filter.....	H-5610	Air Filter Primary.....	AS-7805	Oil Filter Full Flow.....	C-5606
Hydraulic Oil Filter.....	H-56600	Fuel Filter.....	FC-5604	<b>PC100-6</b> (EXCAVATORS) S4D95L-1/40001/143760	
Oil Filter Full Flow.....	C-5614	Hydraulic Oil Filter.....	H-5610	Air Filter Primary.....	A-7939
<b>PC100-1SER</b> (EXCAVATORS)		Hydraulic Oil Filter.....	H-56600	Coolant Filter.....	WC-5707
Air Filter Primary.....	AS-1024	Oil Filter Full Flow.....	C-5604	Hydraulic Oil Filter.....	H-5610
Air Filter Set.....	AS-1024-S	Oil Filter Full Flow.....	C-5405	Hydraulic Oil Filter.....	H-56600
Air Filter Secondary.....	A-6009	<b>PC100-5</b> (EXCAVATORS) KOMATSU S4D95L-1		Oil Filter Full Flow.....	C-5606
Fuel Filter.....	FC-5604	Air Filter Secondary.....	A-5647	<b>PC100-6</b> (EXCAVATORS) S4D105-5	
Hydraulic Oil Filter.....	H-56600	<b>PC100-5</b> (EXCAVATORS) KOMATSU S4D95L-1A		Air Filter Secondary.....	A-6009
Hydraulic Oil Filter.....	H-5610	Air Filter Secondary.....	A-5647	Air Filter Primary.....	AS-1024
Oil Filter Full Flow.....	C-5614	<b>PC100-5</b> (EXCAVATORS) S4D95L		Air Filter Set.....	AS-1024-S
<b>PC100-2</b> (EXCAVATORS) S4D105-5		Air Filter Primary.....	A-7939	Fuel Filter.....	FC-5604
Air Filter Primary.....	AS-1024	Hydraulic Oil Filter.....	H-56600	Hydraulic Oil Filter.....	H-5610
Air Filter Set.....	AS-1024-S	Hydraulic Oil Filter.....	H-5610	Hydraulic Oil Filter.....	H-56600
Air Filter Secondary.....	A-6009	Oil Filter Full Flow.....	C-5606	Oil Filter Full Flow.....	C-5614
Fuel Filter.....	FC-5604	<b>PC100-5</b> (EXCAVATORS) S4D95L-1/28001		<b>PC100L-2</b> (EXCAVATORS) S4D105-5	
Hydraulic Oil Filter.....	H-56600	Air Filter Primary.....	A-7939	Air Filter Primary.....	AS-1024
Hydraulic Oil Filter.....	H-5610	Hydraulic Oil Filter.....	H-56600	Air Filter Set.....	AS-1024-S
Oil Filter Full Flow.....	C-5614	Hydraulic Oil Filter.....	H-5610	Air Filter Secondary.....	A-6009
<b>PC100-2SER</b> (EXCAVATORS)		Oil Filter Full Flow.....	C-5606	Fuel Filter.....	FC-5604
Air Filter Primary.....	AS-1024	<b>PC100-5</b> (EXCAVATORS) S4D95L-1/28001/48797		Hydraulic Oil Filter.....	H-56600
Air Filter Set.....	AS-1024-S	Air Filter Primary.....	A-7939	Hydraulic Oil Filter.....	H-5610
Air Filter Secondary.....	A-6009	Coolant Filter.....	WC-5707	Oil Filter Full Flow.....	C-5614
Fuel Filter.....	FC-5604	<b>PC100-5</b> (EXCAVATORS) S4D95L-1/28001/48797		<b>PC100L-2</b> (EXCAVATORS) S4D105-5	
Hydraulic Oil Filter.....	H-5610	Air Filter Primary.....	A-7939	Air Filter Primary.....	AS-1024
Hydraulic Oil Filter.....	H-56600	Coolant Filter.....	WC-5707	Air Filter Set.....	AS-1024-S

MODEL/APPLICATION	SAKURA NO	MODEL/APPLICATION	SAKURA NO	MODEL/APPLICATION	SAKURA NO
<b>KOMATSU</b>		<b>KOMATSU</b>		<b>KOMATSU</b>	
<b>PC100L-3</b> (EXCAVATORS) 6D125-1		Fuel Filter.....	F-5207	<b>PC1100SE-6</b> (EXCAVATORS) SAA6D170E	
Fuel Filter.....	FC-5604	Hydraulic Oil Filter.....	H-5625	Fuel Filter.....	FC-5606
Oil Filter Full Flow.....	C-5604	Oil Filter Full Flow.....	C-8012	<b>PC1100SE-6</b> (EXCAVATORS) SAA6D170E-2/10001	
<b>PC100SS-2</b> (EXCAVATORS) S4D105-5		<b>PC10-7</b> (EXCAVATORS) 3D78N-1/25001/27776		Air Filter Secondary.....	A-5610
Air Filter Primary.....	AS-1024	Air Filter.....	AS-1824	Air Filter Primary.....	A-5614
Air Filter Set.....	AS-1024-S	Fuel Filter.....	F-5207	Coolant Filter.....	WC-56010
Air Filter Secondary.....	A-6009	Oil Filter Full Flow.....	C-8012	Fuel Filter.....	FC-5602
Fuel Filter.....	FC-5604	Oil Filter Full Flow.....	C-5708	Hydraulic Oil Filter.....	H-2709
Hydraulic Oil Filter.....	H-56600	<b>PC10-7</b> (EXCAVATORS) 3D74E-3/27777		Hydraulic Oil Filter Return.....	HC-5603
Hydraulic Oil Filter.....	H-5610	Air Filter.....	AS-5412	Oil Filter Full Flow.....	C-5701
Oil Filter Full Flow.....	C-5614	Fuel Filter.....	F-5207	Oil Filter Full Flow.....	C-5715
<b>PC10-1</b> (EXCAVATORS) 2D94-1		Oil Filter Full Flow.....	C-5205	Oil Filter Full Flow.....	C-5605
Hydraulic Oil Filter.....	HC-5602	Oil Filter Full Flow.....	C-5708	<b>PC1100SP-6</b> (EXCAVATORS) SAA6D170	
Oil Filter Full Flow.....	C-5606	<b>PC1100-1</b> (EXCAVATORS) SAA6D170		Air Filter Secondary.....	A-5610
<b>PC10-1</b> (EXCAVATORS) 2D94-2		Air Filter Secondary.....	A-5610	Air Filter Primary.....	A-5614
Oil Filter Full Flow.....	C-5606	Air Filter Primary.....	A-5614	Coolant Filter.....	WC-56010
<b>PC10-2</b> (EXCAVATORS) 3D72-1		Coolant Filter.....	WC-56010	Fuel Filter.....	FC-5602
Hydraulic Oil Filter.....	HC-5602	Fuel Filter.....	FC-5602	Hydraulic Oil Filter.....	H-2709
<b>PC10-2</b> (EXCAVATORS) 3D75-1		Hydraulic Oil Filter Return.....	HC-5603	Hydraulic Oil Filter.....	H-5652
Fuel Filter.....	F-5207	Hydraulic Oil Filter.....	H-5652	Hydraulic Oil Filter Return.....	HC-5603
Oil Filter Full Flow.....	C-1920	Hydraulic Oil Filter.....	H-2709	Oil Filter Full Flow.....	C-5605
<b>PC10-3</b> (EXCAVATORS) 3D72-1		Oil Filter Full Flow.....	C-5605	Oil Filter Full Flow.....	C-5701
Hydraulic Oil Filter.....	HC-5602	Oil Filter Full Flow.....	C-5715	Oil Filter Full Flow.....	C-5715
<b>PC10-3</b> (EXCAVATORS) 3D75-1		Oil Filter Full Flow.....	C-5701	<b>PC12</b> (EXCAVATORS) 3TN66E	
Fuel Filter.....	F-5207	<b>PC1100-6</b> (EXCAVATORS) SAA6D170		Air Filter Primary.....	AS-1014
Oil Filter Full Flow.....	C-1920	Air Filter Secondary.....	A-5610	Hydraulic Oil Filter.....	H-5607
<b>PC10-5</b> (EXCAVATORS) 3D75-2/7001		Air Filter Primary.....	A-5614	<b>PC120</b> (EXCAVATORS) S4D95L	
Fuel Filter.....	F-5207	Coolant Filter.....	WC-56010	Air Filter Primary.....	A-7939
Hydraulic Oil Filter.....	H-5607	Fuel Filter.....	FC-5602	Hydraulic Oil Filter.....	H-56600
Oil Filter Full Flow.....	C-8012	Hydraulic Oil Filter.....	H-5652	Hydraulic Oil Filter.....	H-5610
<b>PC10-5</b> (EXCAVATORS) 3D75-2/7001/00101		Hydraulic Oil Filter Return.....	HC-5603	Oil Filter Full Flow.....	C-5606
Fuel Filter.....	F-5207	Hydraulic Oil Filter.....	H-2709	<b>PC120</b> (EXCAVATORS) S4D105	
Hydraulic Oil Filter.....	H-5607	Oil Filter Full Flow.....	C-5605	Air Filter Primary.....	AS-1024
Oil Filter Full Flow.....	C-8012	Oil Filter Full Flow.....	C-5715	Air Filter Set.....	AS-1024-S
<b>PC10-6</b> (EXCAVATORS) 3D75-2/10501/3044		Oil Filter Full Flow.....	C-5701	Fuel Filter.....	FC-5604
Fuel Filter.....	F-5207	<b>PC1100LC-6</b> (EXCAVATORS) SAA6D170		Hydraulic Oil Filter.....	H-5610
Hydraulic Oil Filter.....	H-5625	Air Filter Primary.....	A-5614	Hydraulic Oil Filter.....	H-56600
<b>PC10-6</b> (EXCAVATORS) 3D75-2/10501		Air Filter Secondary.....	A-5610	Oil Filter Full Flow.....	C-5614
Fuel Filter.....	F-5207	Coolant Filter.....	WC-56010	<b>PC120-1</b> (EXCAVATORS) S4D105-5	
Hydraulic Oil Filter.....	H-5625	Fuel Filter.....	FC-5602	Air Filter Primary.....	AS-1024
Oil Filter Full Flow.....	C-8012	Hydraulic Oil Filter Return.....	HC-5603	Air Filter Set.....	AS-1024-S
<b>PC10-6</b> (EXCAVATORS) 3D75-2/10501/03044		Hydraulic Oil Filter.....	H-2709	Air Filter Secondary.....	A-6009
Fuel Filter.....	F-5207	Hydraulic Oil Filter.....	H-5652	Fuel Filter.....	FC-5604
Hydraulic Oil Filter.....	H-5625	Oil Filter Full Flow.....	C-5715	Hydraulic Oil Filter.....	H-56600
Oil Filter Full Flow.....	C-8012	Oil Filter Full Flow.....	C-5701	Hydraulic Oil Filter.....	H-5610
<b>PC10-6</b> (EXCAVATORS) 3D75-2/10501/03044		Oil Filter Full Flow.....	C-5605	Oil Filter Full Flow.....	C-5614
Fuel Filter.....	F-5207	<b>PC1100LC-6</b> (EXCAVATORS) SAA6D170E		<b>PC120-2</b> (EXCAVATORS) S4D105-5	
Hydraulic Oil Filter.....	H-5625	Fuel Filter.....	FC-5606	Air Filter Secondary.....	A-6009
Oil Filter Full Flow.....	C-8012	<b>PC1100LC-6</b> (EXCAVATORS) SAA6D170E		Air Filter Primary.....	AS-1024
<b>PC10-6</b> (EXCAVATORS) 3D75-2/10501/03044		Fuel Filter.....	FC-5606		

MODEL/APPLICATION	SAKURA NO	MODEL/APPLICATION	SAKURA NO	MODEL/APPLICATION	SAKURA NO
<b>KOMATSU</b>		<b>KOMATSU</b>		<b>KOMATSU</b>	
<b>PC120-2</b> (EXCAVATORS) S4D105-5		Air Filter Secondary.....	A-5647	Air Filter Secondary.....	A-6008
Air Filter Set.....	AS-1024-S	<b>PC120-5</b> (EXCAVATORS) KOMATSU S4D95L-1		Air Filter Set.....	A-5663-S
Fuel Filter.....	FC-5604	Air Filter Secondary.....	A-5647	Air Filter Primary.....	A-5627
Hydraulic Oil Filter.....	H-5610	<b>PC120-5</b> (EXCAVATORS) S4D95L		Hydraulic Oil Filter.....	H-56600
Hydraulic Oil Filter.....	H-56600	Air Filter Primary.....	A-7939	Hydraulic Oil Filter.....	H-5610
Oil Filter Full Flow.....	C-5614	Hydraulic Oil Filter.....	H-56600	Oil Filter Full Flow.....	C-5703
<b>PC120-3</b> (EXCAVATORS) 4D95L-1		Hydraulic Oil Filter.....	H-5610	<b>PC120-6</b> (EXCAVATORS) S4D95L	
Air Filter Secondary.....	A-7806	Oil Filter Full Flow.....	C-5606	Air Filter Primary.....	A-7939
Air Filter Primary.....	AS-7805	<b>PC120-5</b> (EXCAVATORS) S4D95L-1/30001/48797		Hydraulic Oil Filter.....	H-56600
Fuel Filter.....	FC-5604	Air Filter Primary.....	A-7939	Hydraulic Oil Filter.....	H-5610
Hydraulic Oil Filter.....	H-5610	Coolant Filter.....	WC-5707	Hydraulic Oil Filter.....	H-5610
Hydraulic Oil Filter.....	H-56600	Hydraulic Oil Filter.....	H-56600	Oil Filter Full Flow.....	C-5606
Oil Filter Full Flow.....	C-5604	Hydraulic Oil Filter.....	H-5610	<b>PC120-6</b> (EXCAVATORS) S4D95L-1/45001/143760	
<b>PC120-3</b> (EXCAVATORS) 6D125-1/18001		Oil Filter Full Flow.....	C-5606	Air Filter Primary.....	A-7939
Air Filter Secondary.....	A-7806	<b>PC120-5</b> (EXCAVATORS) S4D95L-1/30001		Coolant Filter.....	WC-5707
Air Filter Primary.....	AS-7805	Air Filter Primary.....	A-7939	Hydraulic Oil Filter.....	H-56600
Fuel Filter.....	FC-5604	Hydraulic Oil Filter.....	H-56600	Hydraulic Oil Filter.....	H-5610
Hydraulic Oil Filter.....	H-5610	Hydraulic Oil Filter.....	H-5610	Oil Filter Full Flow.....	C-5606
Hydraulic Oil Filter.....	H-56600	Oil Filter Full Flow.....	C-5606	<b>PC120-6</b> (EXCAVATORS) S4D95L-1/45001/57000	
Oil Filter Full Flow.....	C-5604	<b>PC120-6</b> (EXCAVATORS) KOMATSU S4D95L		Air Filter Primary.....	A-7939
<b>PC120-3</b> (EXCAVATORS) 6D95L		Air Filter Secondary.....	A-5647	Hydraulic Oil Filter.....	H-56600
Air Filter Secondary.....	A-7806	<b>PC120-6</b> (EXCAVATORS) KOMATSU S4D102E-1E-2		Hydraulic Oil Filter.....	H-5610
Air Filter Primary.....	AS-7805	Oil Filter Full Flow.....	C-5712	Oil Filter Full Flow.....	C-5606
Fuel Filter.....	FC-5604	<b>PC120-6</b> (EXCAVATORS) KOMATSU S4D102E		<b>PC120LC-6</b> (EXCAVATORS) KOMATSU S4D102E-1E-2	
Hydraulic Oil Filter.....	H-56600	Air Filter Primary.....	A-5627	Oil Filter Full Flow.....	C-5712
Hydraulic Oil Filter.....	H-5610	Air Filter Secondary.....	A-6008	<b>PC120LC-6</b> (EXCAVATORS) S4D102E	
Oil Filter Full Flow.....	C-5405	Air Filter Set.....	A-5663-S	Air Filter Primary.....	A-5627
<b>PC120-3</b> (EXCAVATORS) 6D95L-1/18001		Fuel Filter Secondary.....	FC-7903	Air Filter Secondary.....	A-6008
Air Filter Secondary.....	A-7806	Fuel/Water Separator.....	SFC-5708	Air Filter Set.....	A-5663-S
Air Filter Primary.....	AS-7805	Hydraulic Oil Filter.....	H-5610	Fuel Filter.....	FC-5604
Fuel Filter.....	FC-5604	Hydraulic Oil Filter.....	H-56600	Hydraulic Oil Filter.....	H-56600
Hydraulic Oil Filter.....	H-5610	Oil Filter Full Flow.....	C-5606	Hydraulic Oil Filter.....	H-5610
Hydraulic Oil Filter.....	H-56600	<b>PC120-6</b> (EXCAVATORS) S495L-1/45001/143760		Oil Filter Full Flow.....	C-5614
Oil Filter Full Flow.....	C-5604	Air Filter Primary.....	A-7939	<b>PC120LC-6</b> (EXCAVATORS) SAA4D102E-2	
<b>PC120-3</b> (EXCAVATORS) 6D95L-1/18001/10001/20188		Coolant Filter.....	WC-5707	Air Filter Secondary.....	A-5674
Air Filter Secondary.....	A-7806	Hydraulic Oil Filter.....	H-56600	<b>PC120SS-2</b> (EXCAVATORS) S4D105-5	
Air Filter Primary.....	AS-7805	Hydraulic Oil Filter.....	H-5610	Air Filter Secondary.....	A-6009
Coolant Filter.....	WC-5707	Oil Filter Full Flow.....	C-5606	Air Filter Primary.....	AS-1024
Fuel Filter.....	FC-5604	<b>PC120-6</b> (EXCAVATORS) S4D102E		Air Filter Set.....	AS-1024-S
Hydraulic Oil Filter.....	H-5610	Air Filter Set.....	A-5663-S	Fuel Filter.....	FC-5604
Hydraulic Oil Filter.....	H-56600	Air Filter Primary.....	A-5627	Hydraulic Oil Filter.....	H-56600
Oil Filter Full Flow.....	C-5604	Air Filter Secondary.....	A-6008	Hydraulic Oil Filter.....	H-5610
<b>PC120-3</b> (EXCAVATORS) 6D95L-1/18001/20188		Fuel Filter Secondary.....	FC-7903	Oil Filter Full Flow.....	C-5614
Air Filter Primary.....	AS-7805	Fuel/Water Separator.....	SFC-5708	<b>PC1250</b> (EXCAVATORS)	
Coolant Filter.....	WC-5707	Hydraulic Oil Filter.....	H-5610	Air Filter Secondary.....	A-6011
Fuel Filter.....	FC-5604	Hydraulic Oil Filter.....	H-56600	Air Filter Primary.....	A-6010
Hydraulic Oil Filter.....	H-5610	Hydraulic Oil Filter.....	H-56600	Cabin Air Filter.....	CA-5602
Hydraulic Oil Filter.....	H-56600	<b>PC120-6</b> (EXCAVATORS) S4D102E-1/57001		Cabin Air Filter.....	CA-56041
Oil Filter Full Flow.....	C-5604	Air Filter Set.....	A-5663-S	Fuel/Water Separator.....	SFC-5601-02
<b>PC120-5</b> (EXCAVATORS) KOMATSU S4D95L		Air Filter Primary.....	A-5627	Hydraulic Oil Filter Return.....	HC-5603
Air Filter Primary.....	AS-7805	Air Filter Secondary.....	A-6008	Hydraulic Oil Filter.....	H-2709
Coolant Filter.....	WC-5707	Fuel Filter Secondary.....	FC-7903		
Fuel Filter.....	FC-5604	Fuel/Water Separator.....	SFC-5708		
Hydraulic Oil Filter.....	H-5610	Hydraulic Oil Filter.....	H-5610		
Hydraulic Oil Filter.....	H-56600	Hydraulic Oil Filter.....	H-56600		
Oil Filter Full Flow.....	C-5604				

MODEL/APPLICATION	SAKURA NO	MODEL/APPLICATION	SAKURA NO	MODEL/APPLICATION	SAKURA NO
<b>KOMATSU</b>		<b>KOMATSU</b>		<b>KOMATSU</b>	
<b>PC1250</b> (EXCAVATORS)		Fuel/Water Separator Secondary..	SFC-5611-10B	Oil Filter Full Flow.....	C-5703
Oil Filter Full Flow.....	C-5605	Fuel/Water Separator Secondary...	SFC-5611-10	<b>PC128UU-1</b> (EXCAVATORS) KOMATSU S4D95L	
Oil Filter Full Flow.....	C-5701	Hydraulic Oil Filter.....	H-5618	Air Filter Secondary.....	A-5647
Oil Filter Full Flow.....	C-5715	Hydraulic Oil Filter Return.....	HC-5603	<b>PC128UU-1</b> (EXCAVATORS) KOMATSU S4D102E-1F-2	
<b>PC1250-7</b> (EXCAVATORS) KOMATSU SAA6D170E		<b>PC1250SP-7</b> (EXCAVATORS) SAA6D170E-3		Air Filter Secondary.....	A-5647
Hydraulic Oil Filter.....	H-56770	Cabin Air Filter.....	CA-56041	<b>PC128UU-1</b> (EXCAVATORS) KOMATSU S4D95L-1L	
<b>PC1250-7</b> (EXCAVATORS) SAA6D170E		Coolant Filter.....	WC-56010	Air Filter Secondary.....	A-5647
Air Filter Primary.....	A-8665M	Fuel/Water Separator.....	SFC-5601-02	<b>PC128UU-1</b> (EXCAVATORS) KOMATSU S4D95L-1L	
Air Filter Secondary.....	A-8580	Hydraulic Oil Filter.....	H-5618	Air Filter Secondary.....	A-5647
Hydraulic Oil Filter.....	H-2709	Hydraulic Oil Filter.....	H-2709	<b>PC128UU-1</b> (EXCAVATORS)	
Hydraulic Oil Filter Return.....	HC-5603	Hydraulic Oil Filter Return.....	HC-5603	Air Filter Primary.....	A-7939
Hydraulic Oil Filter.....	H-5618	Hydraulic Breather.....	H-56610	Fuel Filter Secondary.....	FC-7903
Hydraulic Breather.....	H-56610	Oil Filter Full Flow.....	C-5715	Fuel/Water Separator.....	SFC-5708
Oil Filter Full Flow.....	C-5605	Oil Filter Full Flow.....	C-5701	Hydraulic Oil Filter.....	H-5609
Oil Filter Full Flow.....	C-5701	Oil Filter Full Flow.....	C-5605	Oil Filter Full Flow.....	C-5608
Oil Filter Full Flow.....	C-5715	<b>PC1250SP-8</b> (EXCAVATORS) KOMATSU SAA6D170E-5C		<b>PC128UU-1</b> (EXCAVATORS) S4AD102E-1/2347	
<b>PC1250-8</b> (EXCAVATORS) KOMATSU SAA6D170E-5C		Fuel/Water Separator.....	SFC-56020	Fuel Filter Secondary.....	FC-7903
Fuel/Water Separator.....	SFC-56020	Fuel/Water Separator.....	SFC-56020B	Fuel/Water Separator.....	SFC-5708
Fuel/Water Separator.....	SFC-56020B	<b>PC1250SP-8</b> (EXCAVATORS) KOMATSU SAA6D170E-5C-01		Oil Filter Full Flow.....	C-5703
<b>PC1250-8</b> (EXCAVATORS) KOMATSU SAA6D170E-5C-01		Fuel/Water Separator.....	SFC-56020	<b>PC128UU-1</b> (EXCAVATORS) S4D102E	
Fuel/Water Separator.....	SFC-56020	Fuel/Water Separator.....	SFC-56020B	Fuel Filter Secondary.....	FC-7903
Fuel/Water Separator.....	SFC-56020B	<b>PC1250SP-8</b> (EXCAVATORS) SAA6D170E-5		Fuel/Water Separator.....	SFC-5708
<b>PC1250-8</b> (EXCAVATORS) SAA6D170E-5		Coolant Filter.....	WC-56010	Hydraulic Oil Filter.....	H-56600
Coolant Filter.....	WC-56010	Fuel/Water Separator Secondary..	SFC-5611-10	Oil Filter Full Flow.....	C-5703
Fuel/Water Separator Secondary..	SFC-5611-10	Fuel/Water Separator Secondary..	SFC-5611-10B	<b>PC128UU-1</b> (EXCAVATORS) S4D95L-1/1001 - 2346	
Fuel/Water Separator Secondary..	SFC-5611-10B	Hydraulic Oil Filter.....	H-5618	Air Filter Primary.....	A-7939
Hydraulic Oil Filter.....	H-5618	Hydraulic Oil Filter Return.....	HC-5603	Hydraulic Oil Filter.....	H-56600
Hydraulic Oil Filter Return.....	HC-5603	<b>PC128US-1</b> (EXCAVATORS) KOMATSU S4D102E-1F-US		Hydraulic Oil Filter.....	H-5610
<b>PC1250LC-7</b> (EXCAVATORS) SAA6D170E-3		Air Filter Secondary.....	A-5647	Oil Filter Full Flow.....	C-5606
Cabin Air Filter.....	CA-56041	<b>PC128US-1</b> (EXCAVATORS) S4D102E		<b>PC128UU-1</b> (EXCAVATORS) S4D102E/2347/26200415	
Coolant Filter.....	WC-56010	Fuel Filter Secondary.....	FC-7903	Air Filter Primary.....	A-7939
Fuel/Water Separator.....	SFC-5601-02	Fuel/Water Separator.....	SFC-5708	Air Filter Set.....	A-5652-S
Hydraulic Oil Filter Return.....	HC-5603	Hydraulic Oil Filter.....	H-56600	Fuel Filter Secondary.....	FC-7903
Hydraulic Oil Filter.....	H-5618	Oil Filter Full Flow.....	C-5703	Fuel/Water Separator.....	SFC-5708
Hydraulic Oil Filter.....	H-2709	<b>PC128US-2</b> (EXCAVATORS) KOMATSU S4D102E-1V		Hydraulic Oil Filter.....	H-56600
Hydraulic Breather.....	H-56610	Oil Filter Full Flow.....	C-5712	Hydraulic Oil Filter.....	H-5610
Oil Filter Full Flow.....	C-5715	<b>PC128US-2</b> (EXCAVATORS) KOMATSU SAA6D102E-2D-4		Oil Filter Full Flow.....	C-5703
Oil Filter Full Flow.....	C-5605	Oil Filter Full Flow.....	C-5712	<b>PC128UU-2</b> (EXCAVATORS) KOMATSU S4D102E-1V-2	
Oil Filter Full Flow.....	C-5701	<b>PC128US-2</b> (EXCAVATORS)		Oil Filter Full Flow.....	C-5712
<b>PC1250LC-8</b> (EXCAVATORS) KOMATSU SAA6D170E-5C		Air Filter Primary.....	A-5541	<b>PC128UU-2</b> (EXCAVATORS) KOMATSU SAA4D102E-2D-4	
Fuel/Water Separator.....	SFC-56020B	Air Filter Secondary.....	A-5540	Oil Filter Full Flow.....	C-5712
Fuel/Water Separator.....	SFC-56020	Fuel Filter Secondary.....	FC-7903	<b>PC128UU-2</b> (EXCAVATORS) S4D102E	
<b>PC1250LC-8</b> (EXCAVATORS) KOMATSU SAA6D170E-5C-01		Fuel/Water Separator.....	SFC-5708	Fuel Filter Secondary.....	FC-7903
Fuel/Water Separator.....	SFC-56020B	<b>PC128US-2</b> (EXCAVATORS) S4D102E		Fuel/Water Separator.....	SFC-5708
Fuel/Water Separator.....	SFC-56020	Fuel Filter Secondary.....	FC-7903	Hydraulic Oil Filter.....	H-56600
<b>PC1250LC-8</b> (EXCAVATORS) SAA6D170E-5		Fuel/Water Separator.....	SFC-5708	Oil Filter Full Flow.....	C-5703
Coolant Filter.....	WC-56010	<b>PC128US-2</b> (EXCAVATORS) S4D102E		<b>PC128UU-2</b> (EXCAVATORS) S4D102E	
<b>PC1250LC-8</b> (EXCAVATORS) SAA6D170E-5		Fuel Filter Secondary.....	FC-7903	Fuel Filter Secondary.....	FC-7903
Coolant Filter.....	WC-56010	Fuel/Water Separator.....	SFC-5708	Fuel/Water Separator.....	SFC-5708
<b>PC1250LC-8</b> (EXCAVATORS) SAA6D170E-5		Hydraulic Oil Filter.....	H-56600	Hydraulic Oil Filter.....	H-56600
Coolant Filter.....	WC-56010			Oil Filter Full Flow.....	C-5703



MODEL/APPLICATION	SAKURA NO	MODEL/APPLICATION	SAKURA NO	MODEL/APPLICATION	SAKURA NO
<b>KOMATSU</b>		<b>KOMATSU</b>		<b>KOMATSU</b>	
<b>PC12R-8</b> (EXCAVATORS) 3D68E-3		<b>PC130-7</b> (EXCAVATORS) SAA4D95LE		Oil Filter Full Flow.....	C-5405
Air Filter Primary.....	A-8504	Air Filter Primary.....	A-5541	<b>PC1500</b> (EXCAVATORS) S6D170	
Fuel Filter.....	F-5207	Air Filter Secondary.....	A-5540	Air Filter Secondary.....	A-5610
Oil Filter Full Flow.....	C-5205	Fuel Filter.....	FC-1801	Air Filter Primary.....	A-5614
Oil Filter Full Flow.....	C-5708	Hydraulic Oil Filter.....	H-56600	Coolant Filter.....	WC-6901
<b>PC12UU-2</b> (EXCAVATORS) 3D68E-3		Oil Filter Full Flow.....	C-56191	Fuel Filter.....	FC-5602
Air Filter.....	AS-5412	Oil Filter Full Flow.....	C-56190	Hydraulic Oil Filter.....	H-85680
Fuel Filter.....	F-5207	<b>PC138-2</b> (EXCAVATORS) 2008		Hydraulic Oil Filter.....	H-7911
Oil Filter Full Flow.....	C-5205	Air Filter Primary.....	A-5541	Oil Filter Full Flow.....	C-5605
<b>PC12UU-2</b> (EXCAVATORS) 3D68E-3E/4601		Fuel Filter.....	FC-1801	Oil Filter Full Flow.....	C-5701
Air Filter.....	AS-5412	Hydraulic Oil Filter.....	H-56650	Oil Filter Full Flow.....	C-5715
Fuel Filter.....	F-5207	Oil Filter Full Flow.....	C-56191	<b>PC1500-1</b> (EXCAVATORS) 2D94-2C	
Oil Filter Full Flow.....	C-5205	Oil Filter Full Flow.....	C-56190	Air Filter Secondary.....	A-5610
<b>PC12UU-2</b> (EXCAVATORS) 3D72N-2BB/30001/4600		<b>PC138US-2</b> (EXCAVATORS) 2008		Air Filter Primary.....	A-5614
Air Filter.....	AS-5412	Air Filter Primary.....	A-5541	Coolant Filter.....	WC-5703
Fuel Filter.....	F-5207	Air Filter Secondary.....	A-5540	Coolant Filter.....	WC-5705
Oil Filter Full Flow.....	C-5205	Fuel Filter.....	FC-1801	Fuel Filter.....	FC-5602
<b>PC130-5K</b> (EXCAVATORS)		Hydraulic Oil Filter.....	H-56650	Oil Filter Full Flow.....	C-5715
Air Filter Secondary.....	A-7964	Oil Filter Full Flow.....	C-56191	Oil Filter By Pass.....	O-5704
Air Filter Primary.....	AS-7988	Oil Filter Full Flow.....	C-56190	<b>PC1500-1</b> (EXCAVATORS) KT-1150 (QTY 2)/10007	
Fuel Filter.....	FC-5715	<b>PC138US-8</b> (EXCAVATORS) SAA4D95LE , 2007		Air Filter Secondary.....	A-5610
Hydraulic Oil Filter.....	H-5610	Air Filter Primary.....	A-5541	Air Filter Primary.....	A-5614
Hydraulic Oil Filter.....	H-56600	Air Filter Secondary.....	A-5540	Coolant Filter.....	WC-6901
Oil Filter Full Flow.....	C-5102	Fuel Filter.....	FC-1801	Fuel Filter.....	FC-5602
<b>PC130-6</b> (EXCAVATORS) KOMATSU S4D102E		Hydraulic Oil Filter.....	H-56650	Hydraulic Oil Filter.....	H-85680
Air Filter Secondary.....	A-5647	Oil Filter Full Flow.....	C-56191	Hydraulic Oil Filter.....	H-7911
<b>PC130-6</b> (EXCAVATORS) KOMATSU S4D102E-1E		Oil Filter Full Flow.....	C-56190	Oil Filter Full Flow.....	C-5701
Oil Filter Full Flow.....	C-5712	<b>PC14R-2</b> (EXCAVATORS) 3D67E-1A , 2006		Oil Filter Full Flow.....	C-5605
<b>PC130-6</b> (EXCAVATORS) KOMATSU S4D95L-1K		Fuel Filter.....	F-5207	Oil Filter Full Flow.....	C-5715
Air Filter Secondary.....	A-5647	<b>PC15</b> (EXCAVATORS) 3TN66E		<b>PC1500-1</b> (EXCAVATORS) S6D170-1/10007/10126	
<b>PC130-6</b> (EXCAVATORS) S4D102E-1/50356		Air Filter Primary.....	AS-1014	Air Filter Secondary.....	A-5610
Air Filter Primary.....	A-5627	Hydraulic Oil Filter.....	H-5607	Air Filter Primary.....	A-5614
Air Filter Secondary.....	A-6008	<b>PC150</b> (EXCAVATORS) 1004.4T		Fuel Filter.....	FC-5602
Air Filter Set.....	A-5663-S	Oil Filter Full Flow.....	C-5102	Hydraulic Oil Filter.....	H-7911
Hydraulic Oil Filter.....	H-5610	<b>PC150</b> (EXCAVATORS) 6D105		Hydraulic Oil Filter.....	H-85680
Hydraulic Oil Filter.....	H-56600	Air Filter Secondary.....	A-6009	Oil Filter Full Flow.....	C-5505
Oil Filter Full Flow.....	C-5703	Hydraulic Oil Filter.....	H-7911	Oil Filter Full Flow.....	C-5701
<b>PC130-6</b> (EXCAVATORS) S4D95L-1/45001 - 50355		Hydraulic Oil Filter.....	H-85680	Oil Filter Full Flow.....	C-5605
Air Filter Primary.....	A-7939	Oil Filter Full Flow.....	C-5614	Oil Filter Full Flow.....	C-5715
Hydraulic Oil Filter.....	H-56600	<b>PC150</b> (EXCAVATORS) S6D95L		<b>PC150-1</b> (EXCAVATORS) 6D105	
Hydraulic Oil Filter.....	H-5610	Air Filter Primary.....	AS-1024	Air Filter Primary.....	AS-1024
Oil Filter Full Flow.....	C-5606	Air Filter Primary.....	AS-7805	Air Filter Set.....	AS-1024-S
<b>PC130-7</b> (EXCAVATORS) 2007		Air Filter Secondary.....	A-6009	Air Filter Secondary.....	A-6009
Fuel Filter.....	FC-1801	Air Filter Secondary.....	A-7806	Hydraulic Oil Filter.....	H-7911
		Fuel Filter.....	FC-5604	Hydraulic Oil Filter.....	H-85680
		Hydraulic Oil Filter.....	H-5610	Oil Filter Full Flow.....	C-5614
		Hydraulic Oil Filter.....	H-56600	<b>PC150-1</b> (EXCAVATORS) 6D105-1/1001/52271	
				Air Filter Primary.....	AS-1024
				Air Filter Set.....	AS-1024-S

MODEL/APPLICATION	SAKURA NO	MODEL/APPLICATION	SAKURA NO	MODEL/APPLICATION	SAKURA NO
<b>KOMATSU</b>		<b>KOMATSU</b>		<b>KOMATSU</b>	
<b>PC150-1</b> (EXCAVATORS) 6D105-1/1001/52271		<b>PC150-5</b> (EXCAVATORS) S6D95L-1GG		Hydraulic Oil Filter..... H-56600	
Coolant Filter.....	WC-5707	Air Filter Set.....	A-5663-S	Hydraulic Oil Filter.....	H-5610
Hydraulic Oil Filter.....	H-85680	Air Filter Secondary.....	A-6008	Oil Filter Full Flow.....	C-5604
Hydraulic Oil Filter.....	H-7911	Air Filter Primary.....	A-5627	<b>PC150LC-3</b> (EXCAVATORS) S6D95L-1/3001/33698	
Oil Filter Full Flow.....	C-5614	Hydraulic Oil Filter.....	H-5610	Air Filter Primary.....	AS-7805
<b>PC150-1</b> (EXCAVATORS) 6D105-1/1001		Hydraulic Oil Filter.....	H-56600	Air Filter Secondary.....	A-7806
Air Filter Secondary.....	A-6009	Oil Filter Full Flow.....	C-5606	Coolant Filter.....	WC-5707
Air Filter Primary.....	AS-1024	<b>PC150-5</b> (EXCAVATORS) S6D95L-1/6001/58644		Fuel Filter.....	FC-5604
Air Filter Set.....	AS-1024-S	Air Filter Primary.....	A-5627	Hydraulic Oil Filter.....	H-56600
Coolant Filter.....	WC-5712	Air Filter Set.....	A-5663-S	Hydraulic Oil Filter.....	H-5610
Hydraulic Oil Filter.....	H-7911	Hydraulic Oil Filter.....	H-56600	Oil Filter Full Flow.....	C-5604
Hydraulic Oil Filter.....	H-85680	Hydraulic Oil Filter.....	H-5610	<b>PC150LC-3</b> (EXCAVATORS) S6D95L-1C/3001	
Oil Filter Full Flow.....	C-5614	Oil Filter Full Flow.....	C-5606	Air Filter Primary.....	AS-7805
<b>PC150-3</b> (EXCAVATORS) S6D95L-1/3001		<b>PC150-6</b> (EXCAVATORS)		Air Filter Secondary.....	A-7806
Air Filter Primary.....	AS-7805	Fuel Filter Secondary.....	FC-7903	Fuel Filter.....	FC-5604
Air Filter Secondary.....	A-7806	Fuel/Water Separator.....	SFC-5708	Hydraulic Oil Filter.....	H-56600
Fuel Filter.....	FC-5604	Hydraulic Oil Filter.....	H-5610	Hydraulic Oil Filter.....	H-5610
Hydraulic Oil Filter.....	H-5610	Hydraulic Oil Filter.....	H-56600	Oil Filter Full Flow.....	C-5604
Hydraulic Oil Filter.....	H-56600	<b>PC150-6K</b> (EXCAVATORS) SA4D102E		<b>PC150LC-6</b> (EXCAVATORS)	
Oil Filter Full Flow.....	C-5604	Air Filter Primary.....	AS-7988	Fuel Filter Secondary.....	FC-7903
<b>PC150-3</b> (EXCAVATORS) S6D95L-1/3001/10001/33697		Air Filter Secondary.....	A-7964	Fuel/Water Separator.....	SFC-5708
Air Filter Primary.....	AS-7805	Fuel/Water Separator.....	SFC-5708	Hydraulic Oil Filter.....	H-5610
Air Filter Secondary.....	A-7806	Hydraulic Oil Filter.....	H-5610	Hydraulic Oil Filter.....	H-56600
Coolant Filter.....	WC-5707	Hydraulic Oil Filter.....	H-56600	<b>PC150LC-6</b> (EXCAVATORS) SA4D102E	
Fuel Filter.....	FC-5604	<b>PC150AV</b> (EXCAVATORS) S6D95L		Air Filter Secondary.....	A-7964
Hydraulic Oil Filter.....	H-5610	Air Filter Primary.....	A-5627	Air Filter Primary.....	AS-7988
Hydraulic Oil Filter.....	H-56600	Air Filter Set.....	A-5663-S	Air Filter Secondary.....	AS-7988
Oil Filter Full Flow.....	C-5604	Hydraulic Oil Filter.....	H-56600	Fuel/Water Separator.....	SFC-5708
<b>PC150-3</b> (EXCAVATORS) S6D95L-1/3001/10001/33698		Hydraulic Oil Filter.....	H-5610	Hydraulic Oil Filter.....	H-5610
Air Filter Primary.....	AS-7805	Hydraulic Oil Filter.....	H-56600	Hydraulic Oil Filter.....	H-56600
Air Filter Secondary.....	A-7806	Oil Filter Full Flow.....	C-5606	<b>PC150LC-6K</b> (EXCAVATORS) SA4D102E	
Coolant Filter.....	WC-5707	<b>PC150LC-1</b> (EXCAVATORS) 6D105		Air Filter Secondary.....	A-7964
Fuel Filter.....	FC-5604	Air Filter Primary.....	AS-1024	Air Filter Primary.....	AS-7988
Hydraulic Oil Filter.....	H-56600	Air Filter Set.....	AS-1024-S	Fuel/Water Separator.....	SFC-5708
Hydraulic Oil Filter.....	H-5610	Air Filter Secondary.....	A-6009	Hydraulic Oil Filter.....	H-5610
Oil Filter Full Flow.....	C-5604	Hydraulic Oil Filter.....	H-85680	Hydraulic Oil Filter.....	H-56600
<b>PC150-3</b> (EXCAVATORS) S6D95L-1C/3001		Hydraulic Oil Filter.....	H-7911	<b>PC150LC-6K</b> (EXCAVATORS) SA4D102E-1A/K30001/21240928	
Air Filter Secondary.....	A-7806	Oil Filter Full Flow.....	C-5614	Air Filter Secondary.....	A-7964
Air Filter Primary.....	AS-7805	<b>PC150LC-3</b> (EXCAVATORS) S6D95L-1/3001		Air Filter Primary.....	AS-7988
Fuel Filter.....	FC-5604	Air Filter Primary.....	AS-7805	Fuel Filter Secondary.....	FC-7903
Hydraulic Oil Filter.....	H-5610	Air Filter Secondary.....	A-7806	Fuel/Water Separator.....	SFC-5708
Hydraulic Oil Filter.....	H-56600	Fuel Filter.....	FC-5604	Hydraulic Oil Filter.....	H-5610
Oil Filter Full Flow.....	C-5604	Hydraulic Oil Filter.....	H-56600	Hydraulic Oil Filter.....	H-56600
<b>PC150-3SER</b> (EXCAVATORS)		Hydraulic Oil Filter.....	H-5610	<b>PC15-1</b> (EXCAVATORS) 3D78-1	
Air Filter Primary.....	AS-7805	Oil Filter Full Flow.....	C-5604	Air Filter Primary.....	AS-2205
Air Filter Secondary.....	A-7806	<b>PC150LC-3</b> (EXCAVATORS) S6D95L-1/3001/10001/33697		Fuel Filter.....	F-5210
Fuel Filter.....	FC-5604	Air Filter Secondary.....	A-7806	Hydraulic Oil Filter.....	H-5607
Hydraulic Oil Filter.....	H-56600	Air Filter Primary.....	AS-7805	Oil Filter Full Flow.....	C-1720
Hydraulic Oil Filter.....	H-5610	Coolant Filter.....	WC-5707	<b>PC15-1</b> (EXCAVATORS) 3D78-1/1001/00603	
Oil Filter Full Flow.....	C-5604	Fuel Filter.....	FC-5604	Air Filter Primary.....	AS-2205
				Fuel Filter.....	F-5210

MODEL/APPLICATION	SAKURA NO	MODEL/APPLICATION	SAKURA NO	MODEL/APPLICATION	SAKURA NO
<b>KOMATSU</b>		<b>KOMATSU</b>		<b>KOMATSU</b>	
<b>PC15-1</b> (EXCAVATORS) 3D78-1/1001/00603		Air Filter Secondary.....	A-5610	Air Filter Secondary.....	A-5674
Hydraulic Oil Filter.....	H-5607	Air Filter Primary.....	A-5614	<b>PC160LC-7K</b> (EXCAVATORS) KOMATSU SAA4D102E	
Oil Filter Full Flow.....	C-8012	Coolant Filter.....	WC-6901	Air Filter Primary.....	A-56731
<b>PC15-2</b> (EXCAVATORS) 3D78-1		Fuel Filter.....	FC-5703	Air Filter Set.....	A-56731-S
Air Filter Primary.....	AS-2205	Fuel/Water Separator.....	SFC-5707	Air Filter Secondary.....	A-56741
Fuel Filter.....	F-5210	Hydraulic Oil Filter.....	H-7911	<b>PC160LC-7K</b> (EXCAVATORS) SAA4D102E	
Hydraulic Oil Filter.....	H-5607	Hydraulic Oil Filter.....	H-85680	Air Filter Secondary.....	A-8670
Oil Filter Full Flow.....	C-1720	Oil Filter Full Flow.....	C-5715	Air Filter Set.....	A-5675-S
<b>PC15-2</b> (EXCAVATORS) 3D78-1/10001/02853		Oil Filter Full Flow.....	C-5701	Air Filter Primary.....	A-5673
Air Filter Primary.....	AS-2205	Oil Filter By Pass.....	C-5718	Air Filter Secondary.....	A-5674
Fuel Filter.....	F-5210	Oil Filter Full Flow.....	C-5605	Cabin Air Filter.....	CA-56041
Hydraulic Oil Filter.....	H-5607	<b>PC160-6K</b> (EXCAVATORS)		Cabin Air Filter.....	CA-5602
Oil Filter Full Flow.....	C-8012	Air Filter Primary.....	AS-7988	Fuel Filter.....	F-5218
<b>PC15-3</b> (EXCAVATORS) 3D82E-3/10001/UP		Air Filter Secondary.....	A-7964	Hydraulic Oil Filter.....	H-5629
Air Filter Primary.....	AS-2205	Fuel Filter Secondary.....	FC-7903	Hydraulic Oil Filter.....	H-5646
Fuel Filter.....	F-5207	Fuel/Water Separator.....	SFC-5708	<b>PC170</b> (EXCAVATORS) 2007	
Oil Filter Full Flow.....	C-8012	Hydraulic Oil Filter.....	H-5610	Air Filter Secondary.....	A-7964
Oil Filter Full Flow.....	C-5708	Hydraulic Oil Filter.....	H-56600	Air Filter Primary.....	AS-7988
<b>PC15-3</b> (EXCAVATORS) 3D82E-3/6222		<b>PC160-7</b> (EXCAVATORS)		Fuel Filter.....	FC-5715
Fuel Filter.....	F-5207	Air Filter Primary.....	A-5673	Hydraulic Oil Filter.....	H-5610
Oil Filter Full Flow.....	C-1011	Air Filter Set.....	A-5675-S	Hydraulic Oil Filter.....	H-56600
Oil Filter Full Flow.....	C-5708	Air Filter Secondary.....	A-8670	Oil Filter Full Flow.....	C-5102
<b>PC15-3</b> (EXCAVATORS) 3D84N-2/5001/6221		Fuel Filter Secondary.....	FC-7903	<b>PC180</b> (EXCAVATORS) PERKINS	
Fuel Filter.....	F-5207	Fuel/Water Separator.....	SFC-5708	Fuel Filter.....	FC-5715
Oil Filter Full Flow.....	C-1011	Fuel/Water Separator.....	SFC-5706	Hydraulic Oil Filter.....	H-56600
Oil Filter Full Flow.....	C-5708	<b>PC160LC-7</b> (EXCAVATORS) KOMATSU SAA4D102E		Hydraulic Oil Filter.....	H-5610
<b>PC15-3</b> (EXCAVATORS) 3D84N-2/5001/6221		Air Filter Secondary.....	A-56741	Oil Filter Full Flow.....	C-5102
Fuel Filter.....	F-5210	Air Filter Primary.....	A-56731	<b>PC180</b> (EXCAVATORS) SAA4D102	
Oil Filter Full Flow.....	C-8012	Air Filter Set.....	A-56731-S	Air Filter Primary.....	AS-7988
Oil Filter Full Flow.....	C-5708	<b>PC160LC-7</b> (EXCAVATORS) SAA4D102E		<b>PC180-3</b> (EXCAVATORS)	
<b>PC15-8</b> (EXCAVATORS) 3D82E-3		Air Filter Secondary.....	A-5674	Air Filter Secondary.....	A-7806
Fuel Filter.....	F-5207	Air Filter Set.....	A-5675-S	Air Filter Primary.....	AS-7805
Oil Filter Full Flow.....	C-5205	Air Filter Primary.....	A-5673	Fuel Filter.....	FC-5604
<b>PC158US-2</b> (EXCAVATORS) S4D102E-1		Air Filter Secondary.....	A-8670	Hydraulic Oil Filter.....	H-5610
Air Filter Primary.....	A-5541	Cabin Air Filter.....	CA-5602	Hydraulic Oil Filter.....	H-56600
Air Filter Secondary.....	A-5540	Cabin Air Filter.....	CA-56041	Oil Filter Full Flow.....	C-5405
Hydraulic Oil Filter.....	H-56600	Fuel Filter.....	F-5218	Oil Filter Full Flow.....	C-5604
<b>PC158USLC-2</b> (EXCAVATORS) S4D102E-1		Hydraulic Oil Filter.....	H-5646	<b>PC180-5K</b> (EXCAVATORS)	
Air Filter Primary.....	A-5541	Hydraulic Oil Filter.....	H-5629	Air Filter Secondary.....	A-7964
Air Filter Secondary.....	A-5540	<b>PC160LC-7E0</b> (EXCAVATORS) KOMATSU SAA4D107E-1		Air Filter Primary.....	AS-7988
Hydraulic Oil Filter.....	H-56600	Air Filter Primary.....	A-56731	Fuel Filter.....	FC-5715
<b>PC15R-8</b> (EXCAVATORS) 3D68E-3		Air Filter Set.....	A-56731-S	Hydraulic Oil Filter Suction.....	H-2706
Air Filter Primary.....	A-8504	<b>PC160LC-7E0</b> (EXCAVATORS) SAA4D107E-1		Hydraulic Oil Filter.....	H-56600
Fuel Filter.....	F-5207	Air Filter Primary.....	A-5673	Hydraulic Oil Filter.....	H-5610
Oil Filter Full Flow.....	C-5205	Air Filter Set.....	A-5675-S	Oil Filter Full Flow.....	C-5102
<b>PC15R-8</b> (EXCAVATORS)		Cabin Air Filter.....	CA-56041	<b>PC180L-3</b> (EXCAVATORS) S6D95L-1P	
Fuel Filter.....	F-5207	Hydraulic Oil Filter.....	H-5646	Air Filter Primary.....	AS-7805
<b>PC1600</b> (EXCAVATORS) SA6D140		Hydraulic Oil Filter.....	H-5629	Oil Filter Full Flow.....	C-5606
<b>PC1600</b> (EXCAVATORS) SA6D140		Hydraulic Breather.....	H-56610		
		Oil Filter Full Flow.....	C-5611		

# Sakura Filter

# ENGINE APPLICATION

MODEL/APPLICATION	SAKURA NO	MODEL/APPLICATION	SAKURA NO	MODEL/APPLICATION	SAKURA NO
<b>KOMATSU</b>		<b>KOMATSU</b>		<b>KOMATSU</b>	
<b>PC180-LC3</b> (EXCAVATORS) S6D95L-1		Oil Filter Full Flow.....	C-5611	<b>PC138USLC-11</b> (EXCAVATORS)	
Air Filter Primary.....	AS-7805	<b>PC160LC-8</b> (EXCAVATORS) SAA4D107E-1D		Hydraulic Oil Filter.....	H-56100
Air Filter Secondary.....	A-7806	Air Filter Secondary.....	A-5674	<b>PC180LC-7E0</b> (EXCAVATORS) SAA4D107E-1 (S/N K45001-UP)	
Coolant Filter.....	WC-5707	Fuel Filter.....	FC-5613	Air Filter Secondary.....	A-5674
Fuel Filter.....	FC-5604	<b>PC180LC-3</b> (EXCAVATORS)		Fuel Filter.....	FC-5613
Hydraulic Oil Filter.....	H-56600	Air Filter Secondary.....	A-7806	<b>PC180LC-7K</b> (EXCAVATORS) SAA4D102E-4 (S/N K40001-UP)	
Hydraulic Oil Filter.....	H-5610	Air Filter Primary.....	AS-7805	Air Filter Secondary.....	A-5674
Oil Filter Full Flow.....	C-5405	Fuel Filter.....	FC-5604	<b>PC180NLC-7E0</b> (EXCAVATORS) SAA4D107E-1 (S/N K45001-UP)	
<b>PC180LC-6K</b> (EXCAVATORS)		Hydraulic Oil Filter.....	H-5610	Air Filter Secondary.....	A-5674
Fuel/Water Separator.....	SFC-5708	Hydraulic Oil Filter.....	H-56600	Fuel Filter.....	FC-5613
Hydraulic Oil Filter.....	H-56600	Oil Filter Full Flow.....	C-5604	<b>PC180NLC-7K</b> (EXCAVATORS) SAA4D102E-4 (S/N K40001-UP)	
<b>PC180LLC-3</b> (EXCAVATORS) S6D95L-1P		<b>PC180LC-7</b> (EXCAVATORS) 2004		Air Filter Secondary.....	A-5674
Air Filter Primary.....	AS-7805	Air Filter Secondary.....	A-8670	Fuel Filter.....	FC-5613
Oil Filter Full Flow.....	C-5606	<b>PC110R-1</b> (EXCAVATORS)		<b>PC180NLC-7K</b> (EXCAVATORS) SAA4D102E-4 (S/N K40001-UP)	
<b>PC18MR-2</b> (EXCAVATORS) KUBOTA , 2005		Air Filter Primary.....	A-5541	Air Filter Secondary.....	A-5674
Fuel Filter.....	F-5207	Air Filter Secondary.....	A-5540	<b>PC1250-8R</b> (EXCAVATORS) KOMATSU SAA6D170E-5CR	
Fuel Filter.....	F-5214	<b>PC130-8</b> (EXCAVATORS) SAA4D95LE-5		Fuel/Water Separator.....	SFC-56020B
<b>PC18MR-2</b> (EXCAVATORS) KOMATSU 3D67E-5		Air Filter Primary.....	A-5541	Fuel/Water Separator.....	SFC-56020
Hydraulic Oil Filter.....	H-56530	Air Filter Secondary.....	A-5540	<b>PC1250-8R</b> (EXCAVATORS) KOMATSU SAA6D170E-5CR-W	
<b>PC118MR-8</b> (EXCAVATORS) SAA4D95LE-5 , 2011		Hydraulic Oil Filter.....	H-5635	Fuel/Water Separator.....	SFC-56020B
Air Filter Primary.....	A-5541	Hydraulic Oil Filter additional part.	H-7105	Fuel/Water Separator.....	SFC-56020
Air Filter Secondary.....	A-5540	Hydraulic Oil Filter.....	H-56650	<b>PC1250LC-8R</b> (EXCAVATORS) KOMATSU SAA6D170E-5CR	
Cabin Air Filter.....	CA-56041	Oil Filter Full Flow.....	C-56191	Fuel/Water Separator.....	SFC-56020B
Fuel/Water Separator.....	SFC-56040	Oil Filter Full Flow.....	C-56190	Fuel/Water Separator.....	SFC-56020
Hydraulic Oil Filter.....	H-56650	<b>PC138USLC-2</b> (EXCAVATORS) KOMATSU S4D102E-1V-2		<b>PC1250LC-8R</b> (EXCAVATORS) KOMATSU SAA6D170E-5CR-W	
Hydraulic Breather.....	H-56610	Oil Filter Full Flow.....	C-5712	Fuel/Water Separator.....	SFC-56020
Oil Filter Full Flow.....	C-56191	<b>PC138USLC-2</b> (EXCAVATORS) S4D102E/1001/1500		Fuel/Water Separator.....	SFC-56020B
Oil Filter Full Flow.....	C-56190	Air Filter Primary.....	A-5541	<b>PC1250SP-8R</b> (EXCAVATORS) KOMATSU SAA6D170E-5CR	
<b>PC138USLC-2A</b> (EXCAVATORS) 1501		Air Filter Secondary.....	A-5540	Fuel/Water Separator.....	SFC-56020
Air Filter Primary.....	A-5541	<b>PC138USLC-2</b> (EXCAVATORS) S/N: 1501		Fuel/Water Separator.....	SFC-56020B
Air Filter Secondary.....	A-5540	Air Filter Secondary.....	A-5540	<b>PC1250SP-8R</b> (EXCAVATORS) KOMATSU SAA6D170E-5CR-W	
Fuel Filter.....	FC-1801	Air Filter Primary.....	A-5541	Fuel/Water Separator.....	SFC-56020
Hydraulic Oil Filter.....	H-56650	Fuel Filter.....	FC-1801	Fuel/Water Separator.....	SFC-56020B
Oil Filter Full Flow.....	C-56191	Hydraulic Oil Filter.....	H-56650	<b>PC100L-6</b> (EXCAVATORS) KOMATSU S4D102E-1D	
Oil Filter Full Flow.....	C-56190	Oil Filter Full Flow.....	C-56191	Oil Filter Full Flow.....	C-5712
<b>PC160LC-8</b> (EXCAVATORS) KOMATSU SAA4D107E-1D , 2011		Oil Filter Full Flow.....	C-56190	<b>PC120-6Z</b> (EXCAVATORS) KOMATSU S4D102E-1E	
Air Filter Secondary.....	A-56741	<b>PC1800-6</b> (EXCAVATORS) SAAD140E		Oil Filter Full Flow.....	C-5712
Air Filter Primary.....	A-56731	Air Filter Primary.....	A-6010	<b>PC20</b> (EXCAVATORS) 3TN75E	
Air Filter Set.....	A-56731-S	Fuel/Water Separator.....	SFC-5601-02	Air Filter Primary.....	AS-1014
<b>PC160LC-8</b> (EXCAVATORS) SAA4D107E-1D , 2011		Fuel/Water Separator Secondary..	SFC-5611-10B	Hydraulic Oil Filter.....	H-5607
Air Filter Secondary.....	A-8670	Fuel/Water Separator Secondary...	SFC-5611-10	<b>PC20</b> (EXCAVATORS) 3TNE74	
Air Filter Set.....	A-5675-S	Oil Filter Full Flow.....	C-5701	Air Filter Primary.....	AS-1014
Air Filter Primary.....	A-5673	Oil Filter Full Flow.....	C-5605	Hydraulic Oil Filter.....	H-5607
Cabin Air Filter.....	CA-56041	Oil Filter By Pass.....	C-5718	<b>PC20</b> (EXCAVATORS) 3TNE74	
Fuel Filter.....	FC-5713	Oil Filter Full Flow.....	C-5715	Air Filter Primary.....	AS-1014
Hydraulic Oil Filter.....	H-5646	<b>PC138USLC-11</b> (EXCAVATORS) KOMATSU SAA4D95LE-7		Hydraulic Oil Filter.....	H-5607
Hydraulic Oil Filter.....	H-5629	Fuel Filter.....	FC-56320		
Hydraulic Breather.....	H-56610				

MODEL/APPLICATION	SAKURA NO	MODEL/APPLICATION	SAKURA NO	MODEL/APPLICATION	SAKURA NO
<b>KOMATSU</b>		<b>KOMATSU</b>		<b>KOMATSU</b>	
<b>PC200</b> <b>(EXCAVATORS)</b>		Fuel Filter..... FC-5614		<b>PC200-3</b> <b>(EXCAVATORS)</b> <b>S6D105-1/20001/61481/78804</b>	
Air Filter Primary..... AS-2205		Fuel/Water Separator Secondary... SFC-5611-10		Air Filter Primary..... A-5605	
Fuel Filter..... F-5207		Fuel/Water Separator Secondary.. SFC-5611-10B		Air Filter Set..... A-5604-S	
Hydraulic Oil Filter..... H-5607		Hydraulic Oil Filter..... HC-5601		Air Filter Secondary..... A-5606	
Oil Filter Full Flow..... C-1920				Coolant Filter..... WC-5707	
<b>PC200</b> <b>(EXCAVATORS)</b> <b>6BT5.9</b>		<b>PC2000-8</b> <b>(EXCAVATORS)</b> <b>KOMATSU SA6D140E-3</b>		Hydraulic Oil Filter..... H-5609	
Coolant Filter..... WC-5707		Fuel/Water Separator..... SFC-56020B		Oil Filter Full Flow..... C-5614	
Fuel Filter Secondary..... FC-7903		Fuel/Water Separator..... SFC-56020			
Fuel/Water Separator..... SFC-5708				<b>PC200-3</b> <b>(EXCAVATORS)</b> <b>S6D105-1/20001/78805</b>	
Fuel/Water Separator..... SFC-5706				Air Filter Secondary..... A-5635	
Hydraulic Oil Filter..... H-5609		<b>PC2000-8</b> <b>(EXCAVATORS)</b> <b>SAA12V40E-3</b>		Air Filter Primary..... A-5639	
Oil Filter Full Flow..... C-5610		Coolant Filter..... WC-56010		Hydraulic Oil Filter..... H-5609	
<b>PC200</b> <b>(EXCAVATORS)</b> <b>6D105</b>		Hydraulic Oil Filter..... HC-5601		Oil Filter Full Flow..... C-5608	
Air Filter Secondary..... A-6009					
Hydraulic Oil Filter..... H-7911		<b>PC200-1</b> <b>(EXCAVATORS)</b> <b>6D105</b>		<b>PC200-3SER</b> <b>(EXCAVATORS)</b>	
Hydraulic Oil Filter..... H-85680		Air Filter Secondary..... A-5603		Air Filter Secondary..... A-5635	
Oil Filter Full Flow..... C-5614		Air Filter Primary..... A-5602		Air Filter Primary..... A-5639	
<b>PC200</b> <b>(EXCAVATORS)</b> <b>KOMATSU S6D95L-1</b>		Coolant Filter..... WC-5707		Hydraulic Oil Filter..... H-5609	
Fuel Filter..... FC-5601		Hydraulic Oil Filter..... H-7911		Oil Filter Full Flow..... C-5608	
<b>PC200</b> <b>(EXCAVATORS)</b> <b>S6D105</b>		Hydraulic Oil Filter..... H-85680			
Air Filter Secondary..... A-5606		Oil Filter Full Flow..... C-5614		<b>PC200-5</b> <b>(EXCAVATORS)</b> <b>S6D95L-1/45001/35360</b>	
Air Filter Primary..... A-5605				Air Filter Primary..... A-5627	
Air Filter Set..... A-5604-S		<b>PC200-1</b> <b>(EXCAVATORS)</b> <b>S6D105</b>		Air Filter Secondary..... A-6008	
Hydraulic Oil Filter..... H-5609		Air Filter Secondary..... A-5603		Air Filter Set..... A-5663-S	
Oil Filter Full Flow..... C-5614		Air Filter Primary..... A-5602		Hydraulic Oil Filter..... H-85680	
<b>PC200</b> <b>(EXCAVATORS)</b> <b>S6D95</b>		Coolant Filter..... WC-5707		Hydraulic Oil Filter..... H-7911	
Air Filter Primary..... AS-1024		Hydraulic Oil Filter..... H-7911		Hydraulic Oil Filter..... H-85680	
Air Filter Set..... AS-1024-S		Hydraulic Oil Filter..... H-85680		Hydraulic Breather..... H-56610	
Air Filter Primary..... A-5602		Oil Filter Full Flow..... C-5614		Oil Filter Full Flow..... C-5606	
Air Filter Secondary..... A-5606					
Air Filter Secondary..... A-6009		<b>PC200-1SER</b> <b>(EXCAVATORS)</b> <b>6D105-1</b>		<b>PC200-5</b> <b>(EXCAVATORS)</b> <b>S6D95L/45001</b>	
Air Filter Secondary..... A-5603		Air Filter Primary..... AS-1024		Air Filter Primary..... A-5627	
Air Filter Primary..... A-5605		Air Filter Set..... AS-1024-S		Air Filter Secondary..... A-6008	
Coolant Filter..... WC-5707		Air Filter Secondary..... A-6009		Air Filter Set..... A-5663-S	
Hydraulic Oil Filter..... H-85680		Coolant Filter..... WC-5707		Hydraulic Oil Filter..... H-7911	
Hydraulic Oil Filter..... H-7911		Oil Filter Full Flow..... C-5614		Hydraulic Oil Filter..... H-85680	
<b>PC2000</b> <b>(EXCAVATORS)</b>				Hydraulic Breather..... H-56610	
Air Filter Secondary..... A-8580		<b>PC200-2</b> <b>(EXCAVATORS)</b> <b>6D105</b>		Oil Filter Full Flow..... C-5606	
Air Filter Primary..... A-8665M		Air Filter Set..... AS-1024-S			
Cabin Air Filter..... CA-56041		Air Filter Primary..... AS-1024		<b>PC200-5SER</b> <b>(EXCAVATORS)</b>	
Fuel/Water Separator Secondary.. SFC-5611-10B		Air Filter Secondary..... A-6009		Air Filter Primary..... A-5627	
Fuel/Water Separator Secondary.. SFC-5611-10		Coolant Filter..... WC-5707		Air Filter Secondary..... A-6008	
Hydraulic Oil Filter..... HC-5601		Hydraulic Oil Filter..... H-85680		Air Filter Set..... A-5663-S	
<b>PC2000-8</b> <b>(EXCAVATORS)</b> <b>SAA12V140E-3 , 2007</b>		Hydraulic Oil Filter..... H-7911		Hydraulic Oil Filter..... H-85680	
Air Filter Secondary..... A-8580		Oil Filter Full Flow..... C-5614		Hydraulic Oil Filter..... H-7911	
Air Filter Primary..... A-8665M				Hydraulic Breather..... H-56610	
Cabin Air Filter..... CA-56041		<b>PC200-2</b> <b>(EXCAVATORS)</b> <b>KOMATSU 6D105-1F</b>		Oil Filter Full Flow..... C-5606	
Coolant Filter..... WC-56010		Hydraulic Oil Filter..... H-5613			
Fuel Filter..... FC-56230				<b>PC200-6</b> <b>(EXCAVATORS)</b> <b>S6D102-1</b>	
		<b>PC200-3</b> <b>(EXCAVATORS)</b> <b>S6D105</b>		Air Filter Primary..... A-5639	
		Air Filter Set..... A-5604-S		Air Filter Secondary..... A-5635	
		Air Filter Secondary..... A-5635		Fuel Filter Secondary..... FC-7903	
		Air Filter Secondary..... A-5606		Fuel Filter..... FS-5601	
		Air Filter Primary..... A-5605		Fuel/Water Separator..... SFC-5706	
		Air Filter Primary..... A-5639		Fuel/Water Separator..... SFC-5708	
		Hydraulic Oil Filter..... H-5609		Hydraulic Oil Filter..... H-85680	
		Oil Filter Full Flow..... C-5608			

MODEL/APPLICATION	SAKURA NO	MODEL/APPLICATION	SAKURA NO	MODEL/APPLICATION	SAKURA NO
<b>KOMATSU</b>		<b>KOMATSU</b>		<b>KOMATSU</b>	
<b>PC200-6</b> (EXCAVATORS) S6D102E		Fuel/Water Separator.....	SFC-5706	Hydraulic Breather.....	H-56610
Air Filter Primary.....	A-5639	Fuel/Water Separator.....	SFC-5708	<b>PC200-8</b> (EXCAVATORS) SAA6D107E-1	
Air Filter Secondary.....	A-5635	Hydraulic Oil Filter.....	H-85680	Fuel Filter.....	FC-5613
Fuel Filter.....	FS-5601	<b>PC200-6B</b> (EXCAVATORS) S6D102E		<b>PC200LC-2</b> (EXCAVATORS) 6D105	
Fuel Filter Secondary.....	FC-7903	Air Filter Primary.....	A-5639	Air Filter Primary.....	AS-1024
Fuel/Water Separator.....	SFC-5708	Air Filter Secondary.....	A-5635	Air Filter Set.....	AS-1024-S
Fuel/Water Separator.....	SFC-5706	Fuel Filter.....	FS-5601	Air Filter Secondary.....	A-6009
Hydraulic Oil Filter.....	H-85680	Fuel Filter Secondary.....	FC-7903	Coolant Filter.....	WC-5707
<b>PC200-6</b> (EXCAVATORS) S6D102E-1/96514		Fuel/Water Separator.....	SFC-5706	Hydraulic Oil Filter.....	H-7911
Air Filter Secondary.....	A-5635	Fuel/Water Separator.....	SFC-5708	Hydraulic Oil Filter.....	H-85680
Air Filter Primary.....	A-5639	Hydraulic Oil Filter.....	H-85680	Oil Filter Full Flow.....	C-5614
Fuel Filter Secondary.....	FC-7903	<b>PC200-6K</b> (EXCAVATORS)		<b>PC200LC-3</b> (EXCAVATORS) S6D105	
Fuel/Water Separator.....	SFC-5708	Air Filter Set.....	AS-5672-S	Air Filter Set.....	A-5604-S
Hydraulic Oil Filter.....	H-85680	Air Filter Secondary.....	A-5671	Air Filter Secondary.....	A-5606
Hydraulic Breather.....	H-56610	Air Filter Primary.....	AS-5670	Air Filter Primary.....	A-5639
Oil Filter Full Flow.....	C-5730	Fuel Filter Secondary.....	FC-7903	Air Filter Secondary.....	A-5635
<b>PC200-6</b> (EXCAVATORS) S6D95L		Fuel/Water Separator.....	SFC-5708	Air Filter Primary.....	A-5605
Air Filter Primary.....	A-5639	Fuel/Water Separator.....	SFC-5706	Hydraulic Oil Filter.....	H-5609
Air Filter Secondary.....	A-5635	Hydraulic Oil Filter Suction.....	H-2706	Oil Filter Full Flow.....	C-5614
Fuel Filter.....	FS-5601	Hydraulic Oil Filter.....	H-56600	<b>PC200LC-3</b> (EXCAVATORS) S6D105-1/20001/61481/78804	
Hydraulic Oil Filter.....	H-85680	Hydraulic Oil Filter.....	H-5610	Air Filter Secondary.....	A-5606
Oil Filter Full Flow.....	C-5606	Oil Filter Full Flow.....	C-5730	Air Filter Set.....	A-5604-S
<b>PC200-6</b> (EXCAVATORS) S6D95L-1/80001/111868		<b>PC200-7</b> (EXCAVATORS) SAA6D102E-2 , 2003		Air Filter Primary.....	A-5605
Air Filter Secondary.....	A-5635	Hydraulic Oil Filter.....	H-5629	Coolant Filter.....	WC-5707
Air Filter Primary.....	A-5639	Hydraulic Oil Filter.....	H-5646	Hydraulic Oil Filter.....	H-5609
Coolant Filter.....	WC-5707	<b>PC200-7</b> (EXCAVATORS) SAA6D102E		Oil Filter Full Flow.....	C-5614
Hydraulic Oil Filter.....	H-7911	Air Filter Secondary.....	A-8578	<b>PC200LC-3</b> (EXCAVATORS) S6D105-1/20001/78805	
Hydraulic Oil Filter.....	H-85680	Air Filter Primary.....	A-8577	Air Filter Secondary.....	A-5635
Hydraulic Breather.....	H-56610	Cabin Air Filter.....	CA-5602	Air Filter Primary.....	A-5639
Oil Filter Full Flow.....	C-5606	Cabin Air Filter.....	CA-56041	Hydraulic Oil Filter.....	H-5609
<b>PC200-6A</b> (EXCAVATORS) S6D102-1		Fuel Filter.....	F-5218	Oil Filter Full Flow.....	C-5608
Air Filter Secondary.....	A-5635	Fuel Filter.....	FC-5621	<b>PC200LC-5</b> (EXCAVATORS) KOMATSU S6D95L-1	
Air Filter Primary.....	A-5639	Hydraulic Oil Filter.....	H-5646	Fuel Filter.....	FC-5601
Fuel Filter.....	FS-5601	Hydraulic Oil Filter.....	H-5629	<b>PC200LC-5</b> (EXCAVATORS) S6D95L-1/45001/35360	
Fuel Filter Secondary.....	FC-7903	<b>PC200-7B</b> (EXCAVATORS) SAA6D102E		Air Filter Primary.....	A-5627
Fuel/Water Separator.....	SFC-5706	Air Filter Primary.....	A-8577	Air Filter Secondary.....	A-6008
Fuel/Water Separator.....	SFC-5708	Air Filter Secondary.....	A-8578	Air Filter Set.....	A-5663-S
Hydraulic Oil Filter.....	H-85680	Cabin Air Filter.....	CA-56041	Hydraulic Oil Filter.....	H-85680
<b>PC200-6A</b> (EXCAVATORS) S6D102E		Cabin Air Filter.....	CA-5602	Hydraulic Oil Filter.....	H-7911
Air Filter Secondary.....	A-5635	Fuel Filter.....	F-5218	Hydraulic Breather.....	H-56610
Air Filter Primary.....	A-5639	Fuel Filter.....	FC-5621	Oil Filter Full Flow.....	C-5606
Fuel Filter.....	FS-5601	Hydraulic Oil Filter.....	H-5646	<b>PC200LC-5</b> (EXCAVATORS) S6D95L/45001	
Fuel Filter Secondary.....	FC-7903	Hydraulic Oil Filter.....	H-5629	Air Filter Secondary.....	A-6008
Fuel/Water Separator.....	SFC-5706	<b>PC200-8</b> (EXCAVATORS) KOMATSU SAA6D107E		Air Filter Set.....	A-5663-S
Fuel/Water Separator.....	SFC-5708	Hydraulic Oil Filter additional part..	H-7105	Air Filter Primary.....	A-5627
Hydraulic Oil Filter.....	H-85680	<b>PC200-8</b> (EXCAVATORS) SAA6D107E		Hydraulic Oil Filter.....	H-7911
<b>PC200-6A</b> (EXCAVATORS) S6D102E		Air Filter Secondary.....	A-5667	Hydraulic Oil Filter.....	H-85680
Air Filter Secondary.....	A-5635	Air Filter Primary.....	A-5666	Hydraulic Breather.....	H-56610
Air Filter Primary.....	A-5639	Cabin Air Filter.....	CA-56041	<b>PC200LC-5</b> (EXCAVATORS) S6D95L/45001	
Fuel Filter.....	FS-5601	Hydraulic Oil Filter.....	H-5629	Air Filter Secondary.....	A-6008
Fuel Filter Secondary.....	FC-7903	Hydraulic Oil Filter.....	H-5646	Air Filter Set.....	A-5663-S
Fuel/Water Separator.....	SFC-5706	<b>PC200-8</b> (EXCAVATORS) SAA6D107E		Air Filter Primary.....	A-5627
Fuel/Water Separator.....	SFC-5708	Air Filter Secondary.....	A-5667	Hydraulic Oil Filter.....	H-7911
Hydraulic Oil Filter.....	H-85680	Air Filter Primary.....	A-5666	Hydraulic Oil Filter.....	H-85680
<b>PC200-6B</b> (EXCAVATORS) S6D102-1		Cabin Air Filter.....	CA-56041	Hydraulic Breather.....	H-56610
Air Filter Secondary.....	A-5635	Hydraulic Oil Filter.....	H-5629	<b>PC200LC-5</b> (EXCAVATORS) S6D95L/45001	
Air Filter Primary.....	A-5639	Hydraulic Oil Filter.....	H-5646	Air Filter Secondary.....	A-6008
Fuel Filter.....	FS-5601	<b>PC200-8</b> (EXCAVATORS) SAA6D107E		Air Filter Set.....	A-5663-S
Fuel Filter Secondary.....	FC-7903	Air Filter Secondary.....	A-5667	Air Filter Primary.....	A-5627
Fuel Filter.....	FS-5601	Air Filter Primary.....	A-5666	Hydraulic Oil Filter.....	H-7911
<b>PC200-6</b> (EXCAVATORS) S6D102E		Cabin Air Filter.....	CA-56041	Hydraulic Oil Filter.....	H-85680
Air Filter Primary.....	A-5639	Hydraulic Oil Filter.....	H-5629	Hydraulic Breather.....	H-56610
Air Filter Secondary.....	A-5635	Hydraulic Oil Filter.....	H-5646		

MODEL/APPLICATION	SAKURA NO	MODEL/APPLICATION	SAKURA NO	MODEL/APPLICATION	SAKURA NO
<b>KOMATSU</b>		<b>KOMATSU</b>		<b>KOMATSU</b>	
<b>PC200LC-5</b> (EXCAVATORS) S6D95L/45001		<b>PC200LC-8</b> (EXCAVATORS) KOMATSU SAA6D107E-1B		Fuel Filter Secondary.....	FC-7903
Oil Filter Full Flow.....	C-5606	Hydraulic Oil Filter additional part..	H-7105	Fuel/Water Separator.....	SFC-5708
<b>PC200LC-6</b> (EXCAVATORS) S6D102-1		<b>PC200LC-8</b> (EXCAVATORS) SAA6D107E		Fuel/Water Separator.....	SFC-5706
Air Filter Secondary.....	A-5635	Air Filter Secondary.....	A-5667	Hydraulic Oil Filter.....	H-85680
Air Filter Primary.....	A-5639	Air Filter Primary.....	A-5666	<b>PC200Z-6LE</b> (EXCAVATORS) S6D102-1	
Fuel Filter Secondary.....	FC-7903	Cabin Air Filter.....	CA-56041	Air Filter Secondary.....	A-5635
Fuel Filter.....	FS-5601	Hydraulic Oil Filter.....	H-5629	Air Filter Primary.....	A-5639
Fuel/Water Separator.....	SFC-5708	Hydraulic Oil Filter.....	H-5646	Fuel Filter Secondary.....	FC-7903
Fuel/Water Separator.....	SFC-5706	Hydraulic Breather.....	H-56610	Fuel Filter.....	FS-5601
Hydraulic Oil Filter.....	H-85680	<b>PC200LC-8</b> (EXCAVATORS) SAA6D107E-1		Fuel/Water Separator.....	SFC-5706
<b>PC200LC-6</b> (EXCAVATORS) S6D102E		Fuel Filter.....	FC-5613	Fuel/Water Separator.....	SFC-5708
Air Filter Primary.....	A-5639	<b>PC200LL-6</b> (EXCAVATORS) S6D102-1		Hydraulic Oil Filter.....	H-85680
Air Filter Secondary.....	A-5635	Air Filter Secondary.....	A-5635	<b>PC200Z-6LE</b> (EXCAVATORS) S6D102E	
Fuel Filter.....	FS-5601	Air Filter Primary.....	A-5639	Air Filter Secondary.....	A-5635
Fuel Filter Secondary.....	FC-7903	Fuel Filter.....	FS-5601	Air Filter Primary.....	A-5639
Fuel/Water Separator.....	SFC-5708	Fuel Filter Secondary.....	FC-7903	Fuel Filter.....	FS-5601
Fuel/Water Separator.....	SFC-5706	Fuel/Water Separator.....	SFC-5706	Fuel Filter Secondary.....	FC-7903
Hydraulic Oil Filter.....	H-85680	Fuel/Water Separator.....	SFC-5706	Fuel/Water Separator.....	SFC-5706
<b>PC200LC-6</b> (EXCAVATORS) S6D102E-1/96514		Hydraulic Oil Filter.....	H-85680	Hydraulic Oil Filter.....	H-85680
Air Filter Secondary.....	A-5635	<b>PC200LL-6</b> (EXCAVATORS) S6D102E		<b>PC20-1</b> (EXCAVATORS) 2D94-2	
Air Filter Primary.....	A-5639	Air Filter Secondary.....	A-5635	Oil Filter Full Flow.....	C-5606
Fuel Filter Secondary.....	FC-7903	Air Filter Primary.....	A-5639	<b>PC20-2</b> (EXCAVATORS) 3D75-1	
Fuel/Water Separator.....	SFC-5708	Fuel Filter.....	FS-5601	Hydraulic Oil Filter.....	H-5607
Hydraulic Oil Filter.....	H-85680	Fuel Filter Secondary.....	FC-7903	<b>PC20-2</b> (EXCAVATORS) 3D84-1	
Hydraulic Breather.....	H-56610	Fuel/Water Separator.....	SFC-5706	Air Filter Primary.....	AS-2205
Oil Filter Full Flow.....	C-5730	Fuel/Water Separator.....	SFC-5708	Air Filter.....	A-8568
<b>PC200LC-6</b> (EXCAVATORS) S6D95L		Hydraulic Oil Filter.....	H-85680	Fuel Filter.....	F-5207
Air Filter Primary.....	A-5639	<b>PC200LL-7</b> (EXCAVATORS) SAA6D102E		Oil Filter Full Flow.....	C-1920
Air Filter Secondary.....	A-5635	Air Filter Primary.....	A-8577	<b>PC20-3</b> (EXCAVATORS) 3D75-1	
Fuel Filter.....	FS-5601	Air Filter Secondary.....	A-8578	Hydraulic Oil Filter.....	H-5607
Hydraulic Oil Filter.....	H-85680	Cabin Air Filter.....	CA-5602	<b>PC20-3</b> (EXCAVATORS) 3D84-1	
Oil Filter Full Flow.....	C-5606	Cabin Air Filter.....	CA-56041	Air Filter Primary.....	AS-2205
<b>PC200LC-7</b> (EXCAVATORS) SAA6D102E		Fuel Filter.....	FC-5621	Air Filter.....	A-8568
Air Filter Primary.....	A-8577	Fuel Filter.....	F-5218	Fuel Filter.....	F-5207
Air Filter Secondary.....	A-8578	Hydraulic Oil Filter.....	H-5629	Oil Filter Full Flow.....	C-1920
Cabin Air Filter.....	CA-56041	Hydraulic Oil Filter.....	H-5646	<b>PC20-5</b> (EXCAVATORS) 3D84-1	
Cabin Air Filter.....	CA-5602	Hydraulic Breather.....	H-56610	Air Filter Primary.....	AS-2205
Fuel Filter.....	FC-5621	<b>PC200Z-6</b> (EXCAVATORS) S6D102-1		Fuel Filter.....	F-5207
Fuel Filter.....	F-5218	Air Filter Primary.....	A-5639	Hydraulic Oil Filter.....	H-5607
Hydraulic Oil Filter.....	H-5629	Air Filter Secondary.....	A-5635	Oil Filter Full Flow.....	C-1920
Hydraulic Oil Filter.....	H-5646	Fuel Filter.....	FS-5601	<b>PC20-5</b> (EXCAVATORS) 3D84-1/18001/13021	
<b>PC200LC-7B</b> (EXCAVATORS) SAA6D102E		Fuel Filter Secondary.....	FC-7903	Air Filter Primary.....	AS-2205
Air Filter Secondary.....	A-8578	Fuel/Water Separator.....	SFC-5708	Fuel Filter.....	F-5207
Air Filter Primary.....	A-8577	Fuel/Water Separator.....	SFC-5706	Hydraulic Oil Filter.....	H-5607
Cabin Air Filter.....	CA-5602	Hydraulic Oil Filter.....	H-85680	Oil Filter Full Flow.....	C-1920
Cabin Air Filter.....	CA-56041	<b>PC200Z-6</b> (EXCAVATORS) S6D102E		<b>PC20-6</b> (EXCAVATORS) 3D84-1	
Fuel Filter.....	F-5218	Air Filter Secondary.....	A-5635	Air Filter Primary.....	AS-2205
Fuel Filter.....	FC-5621	Air Filter Primary.....	A-5639	Fuel Filter.....	F-5207
Hydraulic Oil Filter.....	H-5629	Fuel Filter.....	FS-5601	Hydraulic Oil Filter.....	H-5607
Hydraulic Oil Filter.....	H-5646			Oil Filter Full Flow.....	C-1920

MODEL/APPLICATION	SAKURA NO	MODEL/APPLICATION	SAKURA NO	MODEL/APPLICATION	SAKURA NO
<b>KOMATSU</b>		<b>KOMATSU</b>		<b>KOMATSU</b>	
<b>PC20-6</b> (EXCAVATORS) 3D84-1		Fuel Filter.....	F-5207	Oil Filter Full Flow.....	C-5102
Air Filter Primary.....	AS-2205	Oil Filter Full Flow.....	C-5205		
Fuel Filter.....	F-5207	Oil Filter Full Flow.....	C-8012	<b>PC210-6</b> (EXCAVATORS) S6D102E-1/30980	
Hydraulic Oil Filter.....	H-5607			Air Filter Secondary.....	A-5635
Oil Filter Full Flow.....	C-1920			Air Filter Primary.....	A-5639
		<b>PC20R-8</b> (EXCAVATORS) 3D82AE-3E/10001		Fuel Filter Secondary.....	FC-7903
<b>PC20-6</b> (EXCAVATORS) 3D84-1/24001/25916		Air Filter Primary.....	A-8513	Fuel/Water Separator.....	SFC-5708
Air Filter Primary.....	AS-2205	Air Filter Primary.....	A-8504	Hydraulic Oil Filter.....	H-85680
Fuel Filter.....	F-5207	Fuel Filter.....	F-5207	Hydraulic Breather.....	H-56610
Hydraulic Oil Filter.....	H-5607	Oil Filter Full Flow.....	C-8012	Oil Filter Full Flow.....	C-5730
Oil Filter Full Flow.....	C-1920	Oil Filter Full Flow.....	C-5205		
				<b>PC210-6</b> (EXCAVATORS) S6D95L-1/30001/111868	
<b>PC20-7</b> (EXCAVATORS) 3D84N-2		<b>PC20R-8</b> (EXCAVATORS) 3D82AE-3F/10001		Air Filter Secondary.....	A-5635
Air Filter Primary.....	AS-2205	Air Filter Primary.....	A-8513	Air Filter Primary.....	A-5639
Fuel Filter.....	F-5210	Air Filter Primary.....	A-8504	Coolant Filter.....	WC-5707
Oil Filter Full Flow.....	C-5708	Fuel Filter.....	F-5207	Hydraulic Oil Filter.....	H-85680
Oil Filter Full Flow.....	C-1720	Oil Filter Full Flow.....	C-5205	Hydraulic Oil Filter.....	H-7911
		Oil Filter Full Flow.....	C-8012	Hydraulic Breather.....	H-56610
<b>PC20-7</b> (EXCAVATORS) 3D82E-3/42355/42355		<b>PC20R-8</b> (EXCAVATORS) 3D84E-3/10001		Oil Filter Full Flow.....	C-5606
Fuel Filter.....	F-5207	Air Filter Primary.....	A-8504		
Oil Filter Full Flow.....	C-1011	Fuel Filter.....	F-5207	<b>PC210-6</b> (EXCAVATORS) S6D95L-1/30001/30979/111868	
Oil Filter Full Flow.....	C-5708	Oil Filter Full Flow.....	C-5205	Air Filter Secondary.....	A-5635
		Oil Filter Full Flow.....	C-5708	Air Filter Primary.....	A-5639
<b>PC20-7</b> (EXCAVATORS) 3D84N-2/35001/42354		<b>PC20-SER</b> (EXCAVATORS) 3D84-1		Coolant Filter.....	WC-5707
Fuel Filter.....	F-5210	Fuel Filter.....	F-5207	Hydraulic Oil Filter.....	H-7911
Oil Filter Full Flow.....	C-8012	Hydraulic Oil Filter.....	H-5607	Hydraulic Oil Filter.....	H-85680
Oil Filter Full Flow.....	C-5708	Oil Filter Full Flow.....	C-1920	Hydraulic Breather.....	H-56610
				Oil Filter Full Flow.....	C-5606
<b>PC20-8</b> (EXCAVATORS)		<b>PC210</b> (EXCAVATORS) BT5.9		<b>PC210-6K</b> (EXCAVATORS)	
Fuel Filter.....	F-5207	Coolant Filter.....	WC-5707	Air Filter Primary.....	AS-5670
Oil Filter Full Flow.....	C-5205	Hydraulic Oil Filter.....	H-5609	Air Filter Set.....	AS-5672-S
				Air Filter Secondary.....	A-5671
<b>PC20HT-1</b> (EXCAVATORS) 4D130-1		<b>PC210</b> (EXCAVATORS)		Fuel Filter Secondary.....	FC-7903
Fuel Filter.....	F-2626	Air Filter Primary.....	AS-5670	Fuel/Water Separator.....	SFC-5706
Hydraulic Oil Filter.....	H-7911	Air Filter Secondary.....	A-5671	Fuel/Water Separator.....	SFC-5708
Hydraulic Oil Filter.....	H-85680	Air Filter Set.....	AS-5672-S	Hydraulic Oil Filter.....	H-7911
Oil Filter Full Flow.....	O-5601	Oil Filter Full Flow.....	C-5614	Hydraulic Oil Filter.....	H-85680
<b>PC20MR-2</b> (EXCAVATORS) 3D67E-5		<b>PC210-3</b> (EXCAVATORS)		<b>PC210-7</b> (EXCAVATORS) SAA6D102E , 2004	
Air Filter Secondary.....	A-7618	Air Filter Set.....	AS-5672-S	Air Filter Secondary.....	A-8578
Air Filter Primary.....	A-8504	Air Filter Primary.....	AS-5670	Air Filter Primary.....	A-8577
Fuel Filter.....	F-5207	Fuel Filter.....	FC-5715	Hydraulic Oil Filter.....	H-5629
Oil Filter Full Flow.....	C-8012	Hydraulic Oil Filter.....	H-5609	Hydraulic Oil Filter.....	H-5646
				Oil Filter Full Flow.....	C-5610
<b>PC20MRX-1</b> (EXCAVATORS) 3D74E		<b>PC210-3</b> (EXCAVATORS) S/N: 10001		<b>PC210-7K</b> (EXCAVATORS) SAA6D102E , 2004	
Air Filter Primary.....	A-8504	Air Filter Primary.....	A-5639	Air Filter Secondary.....	A-8578
Fuel Filter.....	F-5207	Hydraulic Oil Filter.....	H-5609	Air Filter Primary.....	A-8577
		Oil Filter Full Flow.....	C-5608	Hydraulic Oil Filter.....	H-5629
<b>PC20R</b> (EXCAVATORS) 3D74E		<b>PC210-5K</b> (EXCAVATORS)		Hydraulic Oil Filter.....	H-5646
Air Filter Primary.....	A-8504	Air Filter Set.....	AS-5672-S	Oil Filter Full Flow.....	C-5610
Fuel Filter.....	F-5207	Air Filter Secondary.....	A-5671		
		Air Filter Primary.....	AS-5670	<b>PC210-8</b> (EXCAVATORS) SAA6D107E , 2006	
<b>PC20R-8</b> (EXCAVATORS) 3D82AE/10001		Fuel Filter.....	FC-5715	Air Filter Secondary.....	A-5667
Air Filter Primary.....	A-8513	Hydraulic Oil Filter.....	H-85680	Air Filter Primary.....	A-5666
Air Filter Primary.....	A-8504	Hydraulic Oil Filter.....	H-7911	Cabin Air Filter.....	CA-56041
				Hydraulic Oil Filter.....	H-5629



MODEL/APPLICATION	SAKURA NO	MODEL/APPLICATION	SAKURA NO	MODEL/APPLICATION	SAKURA NO
<b>KOMATSU</b>		<b>KOMATSU</b>		<b>KOMATSU</b>	
<b>PC210-8</b> (EXCAVATORS) SAA6D107E , 2006		Air Filter Set.....	A-5604-S	Oil Filter Full Flow.....	C-5608
Hydraulic Oil Filter.....	H-5646	Air Filter Secondary.....	A-5606	<b>PC220-3SER</b> (EXCAVATORS)	
Oil Filter Full Flow.....	C-5611	Hydraulic Oil Filter.....	H-5609	Air Filter Primary.....	A-5639
<b>PC210LC-6</b> (EXCAVATORS) S6D102E-1/30980		Oil Filter Full Flow.....	C-5614	Air Filter Set.....	A-5604-S
Air Filter Primary.....	A-5639	<b>PC220-1</b> (EXCAVATORS) S6D102E-1		Air Filter Secondary.....	A-5635
Air Filter Secondary.....	A-5635	Air Filter Secondary.....	A-5408	Air Filter Primary.....	A-5605
Fuel Filter Secondary.....	FC-7903	Air Filter Primary.....	A-6113	Hydraulic Oil Filter.....	H-5609
Fuel/Water Separator.....	SFC-5708	Coolant Filter.....	WC-5707	Oil Filter Full Flow.....	C-5614
Hydraulic Oil Filter.....	H-85680	Hydraulic Oil Filter.....	H-85680	Oil Filter Full Flow.....	C-5608
Hydraulic Breather.....	H-56610	Hydraulic Oil Filter.....	H-7911	<b>PC220-5</b> (EXCAVATORS) SA6D95L-1/35001	
Oil Filter Full Flow.....	C-5730	Oil Filter Full Flow.....	C-5614	Air Filter Set.....	A-5663-S
<b>PC210LC-6</b> (EXCAVATORS) S6D95L-1/30001/111868		<b>PC220-1</b> (EXCAVATORS) S6D102E-1/10001/UP		Air Filter Secondary.....	A-6008
Air Filter Primary.....	A-5639	Air Filter Secondary.....	A-5408	Air Filter Primary.....	A-5627
Air Filter Secondary.....	A-5635	Air Filter Primary.....	A-6113	Fuel Filter.....	FC-5621
Coolant Filter.....	WC-5707	Coolant Filter.....	WC-5707	Hydraulic Oil Filter.....	H-85680
Hydraulic Oil Filter.....	H-7911	Hydraulic Oil Filter.....	H-7911	Hydraulic Oil Filter.....	H-7911
Hydraulic Oil Filter.....	H-85680	Hydraulic Oil Filter.....	H-85680	Hydraulic Breather.....	H-56610
Hydraulic Breather.....	H-56610	Oil Filter Full Flow.....	C-5614	Oil Filter Full Flow.....	C-5606
Oil Filter Full Flow.....	C-5606	<b>PC220-1</b> (EXCAVATORS) S6D105-1		<b>PC220-6</b> (EXCAVATORS) SA6D95L-1/50001	
<b>PC210LC-6</b> (EXCAVATORS) S6D95L-1/30001/30979/111868		Air Filter Secondary.....	A-5408	Air Filter Primary.....	A-5639
Air Filter Secondary.....	A-5635	Air Filter Primary.....	A-6113	Air Filter Secondary.....	A-5635
Air Filter Primary.....	A-5639	Hydraulic Oil Filter.....	H-7911	Hydraulic Oil Filter.....	H-7911
Coolant Filter.....	WC-5707	Hydraulic Oil Filter.....	H-85680	Hydraulic Oil Filter.....	H-85680
Hydraulic Oil Filter.....	H-7911	Hydraulic Oil Filter.....	H-5609	Hydraulic Breather.....	H-56610
Hydraulic Oil Filter.....	H-85680	Oil Filter Full Flow.....	C-5614	Oil Filter Full Flow.....	C-5606
Hydraulic Breather.....	H-56610	<b>PC220-2SER</b> (EXCAVATORS)		<b>PC220-6</b> (EXCAVATORS) SA6D102E-1/52852	
Oil Filter Full Flow.....	C-5606	Air Filter Secondary.....	A-5408	Air Filter Secondary.....	A-5635
<b>PC210LC-7</b> (EXCAVATORS)		Air Filter Primary.....	A-6113	Air Filter Primary.....	A-5639
Air Filter Secondary.....	A-8578	Coolant Filter.....	WC-5707	Fuel Filter Secondary.....	FC-7903
Air Filter Primary.....	A-8577	Hydraulic Oil Filter.....	H-7911	Fuel/Water Separator.....	SFC-5708
Cabin Air Filter.....	CA-56041	Hydraulic Oil Filter.....	H-85680	Hydraulic Oil Filter.....	H-85680
Fuel Filter Secondary.....	FC-7903	Hydraulic Oil Filter.....	H-5609	Hydraulic Breather.....	H-56610
Fuel/Water Separator.....	SFC-5708	Oil Filter Full Flow.....	C-5614	Oil Filter Full Flow.....	C-5730
Oil Filter Full Flow.....	C-5611	<b>PC220-2SER</b> (EXCAVATORS) S6D102E-1		<b>PC220-6SER</b> (EXCAVATORS)	
<b>PC210LC-7K</b> (EXCAVATORS)		Air Filter Secondary.....	A-5408	Air Filter Primary.....	A-5639
Air Filter Primary.....	A-8577	Air Filter Primary.....	A-6113	Hydraulic Oil Filter.....	H-7911
Cabin Air Filter.....	CA-5602	Coolant Filter.....	WC-5707	Hydraulic Oil Filter.....	H-85680
Cabin Air Filter.....	CA-56041	Hydraulic Oil Filter.....	H-7911	Hydraulic Oil Filter.....	H-85680
Fuel Filter Secondary.....	FC-7903	Hydraulic Oil Filter.....	H-85680	Hydraulic Breather.....	H-56610
Fuel/Water Separator.....	SFC-5708	Oil Filter Full Flow.....	C-5614	Oil Filter Full Flow.....	C-5606
Hydraulic Oil Filter.....	H-5629	<b>PC220-2SER</b> (EXCAVATORS) S6D102E-1/10001/UP		<b>PC220-7</b> (EXCAVATORS)	
Hydraulic Oil Filter.....	H-5646	Air Filter Primary.....	A-6113	Air Filter Secondary.....	A-5667
Oil Filter Full Flow.....	C-5610	Air Filter Secondary.....	A-5408	Air Filter Primary.....	A-5666
<b>PC220</b> (EXCAVATORS)		Coolant Filter.....	WC-5707	Hydraulic Oil Filter.....	H-5629
Air Filter Primary.....	AS-5670	Hydraulic Oil Filter.....	H-7911	Hydraulic Oil Filter.....	H-5646
Air Filter Secondary.....	A-5671	Hydraulic Oil Filter.....	H-85680	Hydraulic Breather.....	H-56610
Air Filter Set.....	AS-5672-S	Oil Filter Full Flow.....	C-5614	Oil Filter Full Flow.....	C-5611
Oil Filter Full Flow.....	C-5614	<b>PC220-3</b> (EXCAVATORS) S6D105-1/20001/78506		<b>PC220-7</b> (EXCAVATORS) SAA6D102E	
<b>PC220</b> (EXCAVATORS) S6D105		Air Filter Primary.....	A-5639	Air Filter Secondary.....	A-5667
Air Filter Primary.....	A-5605	Air Filter Secondary.....	A-5635	Air Filter Secondary.....	A-8578
<b>PC220</b> (EXCAVATORS) S6D105		Coolant Filter.....	WC-5707	Air Filter Primary.....	A-8577
Air Filter Primary.....	A-5605	Hydraulic Oil Filter.....	H-5609	Air Filter Primary.....	A-5666

MODEL/APPLICATION	SAKURA NO	MODEL/APPLICATION	SAKURA NO	MODEL/APPLICATION	SAKURA NO
<b>KOMATSU</b>		<b>KOMATSU</b>		<b>KOMATSU</b>	
<b>PC220-7</b> (EXCAVATORS) SAA6D102E		Fuel Filter.....	FC-5601	Air Filter Set.....	AS-5672-S
Cabin Air Filter.....	CA-5602	<b>PC220LC-6</b> (EXCAVATORS) SAGD95L-1/50001		Coolant Filter.....	WC-5707
Cabin Air Filter.....	CA-56041	Air Filter Primary.....	A-5639	Hydraulic Oil Filter.....	H-5609
Fuel Filter.....	FC-5621	Air Filter Secondary.....	A-5635	Hydraulic Oil Filter.....	H-85680
Fuel Filter.....	F-5218	Hydraulic Oil Filter.....	H-7911	Oil Filter Full Flow.....	C-5730
Hydraulic Oil Filter.....	H-5629	Hydraulic Oil Filter.....	H-85680	<b>PC2285</b> (EXCAVATORS) 2003	
Hydraulic Oil Filter.....	H-5646	Hydraulic Breather.....	H-56610	Air Filter Secondary.....	A-8578
<b>PC220-8</b> (EXCAVATORS) KOMATSU SAA6D107E		Oil Filter Full Flow.....	C-5606	Air Filter Primary.....	A-8577
Hydraulic Oil Filter additional part..	H-7105	<b>PC220LC-6</b> (EXCAVATORS) SAGD102E-1/52852		Fuel Filter.....	F-5218
<b>PC220-8</b> (EXCAVATORS) SAA6D107E		Air Filter Primary.....	A-5639	Fuel Filter Secondary.....	FC-7903
Air Filter Secondary.....	A-5667	Air Filter Secondary.....	A-5635	Fuel/Water Separator.....	SFC-5708
Air Filter Secondary.....	A-8578	Fuel Filter Secondary.....	FC-7903	Hydraulic Oil Filter.....	H-5629
Air Filter Primary.....	A-8577	Fuel/Water Separator.....	SFC-5708	Hydraulic Oil Filter.....	H-5646
Air Filter Primary.....	A-5666	Hydraulic Oil Filter.....	H-85680	Oil Filter Full Flow.....	C-5611
Fuel Filter.....	FC-5613	Hydraulic Breather.....	H-56610	<b>PC228US-1</b> (EXCAVATORS) S6D102E	
Hydraulic Oil Filter.....	H-5629	Oil Filter Full Flow.....	C-5730	Air Filter Set.....	AS-5672-S
Hydraulic Oil Filter.....	H-5646	<b>PC220LC-7</b> (EXCAVATORS) SAA6D102E		Air Filter Secondary.....	A-5671
<b>PC220AV</b> (EXCAVATORS) SAGD95L		Air Filter Primary.....	A-8577	Air Filter Primary.....	AS-5670
Air Filter Primary.....	A-5627	Air Filter Secondary.....	A-8578	Coolant Filter.....	WC-5707
Air Filter Set.....	A-5663-S	Air Filter Primary.....	A-5666	Hydraulic Oil Filter.....	H-85680
Hydraulic Oil Filter.....	H-85680	Air Filter Secondary.....	A-5667	Hydraulic Oil Filter.....	H-5609
Hydraulic Oil Filter.....	H-7911	Cabin Air Filter.....	CA-56041	Oil Filter Full Flow.....	C-5730
Oil Filter Full Flow.....	C-5606	Cabin Air Filter.....	CA-5602	<b>PC228US-2</b> (EXCAVATORS) S6D102E	
<b>PC220LC-3</b> (EXCAVATORS) S6D105-1/20001/78506		Fuel Filter.....	FC-5621	Air Filter Secondary.....	A-5671
Air Filter Secondary.....	A-5635	Fuel Filter.....	F-5218	Air Filter Set.....	AS-5672-S
Air Filter Primary.....	A-5639	Hydraulic Oil Filter.....	H-5629	Air Filter Primary.....	AS-5670
Coolant Filter.....	WC-5707	Hydraulic Oil Filter.....	H-5646	Coolant Filter.....	WC-5707
Hydraulic Oil Filter.....	H-5609	<b>PC220LC-8</b> (EXCAVATORS) KOMATSU SAA6D107E-1C-W1		Hydraulic Oil Filter.....	H-5609
Hydraulic Oil Filter.....	H-5608	Hydraulic Oil Filter additional part..	H-7105	Hydraulic Oil Filter.....	H-85680
<b>PC220LC-3</b> (EXCAVATORS) S6D105-1/20001/62361		<b>PC220LC-8</b> (EXCAVATORS) SAA6D107E		Oil Filter Full Flow.....	C-5730
Air Filter Primary.....	A-5639	Air Filter Secondary.....	A-5667	<b>PC228US-3</b> (EXCAVATORS) SAA6D102E , 2004	
Air Filter Secondary.....	A-5606	Air Filter Primary.....	A-5666	Air Filter Primary.....	A-8577
Air Filter Set.....	A-5604-S	Air Filter Primary.....	A-8577	Air Filter Secondary.....	A-8578
Air Filter Primary.....	A-5605	Air Filter Secondary.....	A-8578	Hydraulic Oil Filter.....	H-5629
Air Filter Secondary.....	A-5635	Fuel Filter.....	FC-5613	Hydraulic Oil Filter.....	H-5646
Coolant Filter.....	WC-5707	Hydraulic Oil Filter.....	H-5646	Oil Filter Full Flow.....	C-5611
Hydraulic Oil Filter.....	H-5609	Hydraulic Oil Filter.....	H-5629	Oil Filter Full Flow.....	C-5610
Oil Filter Full Flow.....	C-5608	<b>PC220LL-7</b> (EXCAVATORS) SAA6D102E		<b>PC228USLC-1</b> (EXCAVATORS)	
Oil Filter Full Flow.....	C-5614	Air Filter Secondary.....	A-5667	Air Filter Primary.....	A-5639
<b>PC220LC-5</b> (EXCAVATORS) SAGD95L-1/35001		Air Filter Secondary.....	A-8578	Air Filter Secondary.....	A-5635
Air Filter Secondary.....	A-6008	Air Filter Primary.....	A-8577	Fuel Filter Secondary.....	FC-7903
Air Filter Set.....	A-5663-S	Air Filter Primary.....	A-5666	Fuel/Water Separator.....	SFC-5708
Air Filter Primary.....	A-5627	Cabin Air Filter.....	CA-5602	<b>PC228USLC-1</b> (EXCAVATORS) S6D102E	
Fuel Filter.....	FC-5621	Cabin Air Filter.....	CA-56041	Air Filter Set.....	AS-5672-S
Hydraulic Oil Filter.....	H-85680	Fuel Filter.....	FC-5621	Air Filter Primary.....	AS-5670
Hydraulic Oil Filter.....	H-7911	Fuel Filter.....	F-5218	Air Filter Secondary.....	A-5671
Hydraulic Breather.....	H-56610	Hydraulic Oil Filter.....	H-5629	Coolant Filter.....	WC-5707
Oil Filter Full Flow.....	C-5606	Hydraulic Oil Filter.....	H-5646	Hydraulic Oil Filter.....	H-5609
<b>PC220LC-6</b> (EXCAVATORS) KOMATSU SAGD102E-1C-7		<b>PC228</b> (EXCAVATORS) S6D102E		Hydraulic Oil Filter.....	H-85680
Air Filter Secondary.....	A-5671	Air Filter Secondary.....	A-5671	Oil Filter Full Flow.....	C-5730
Air Filter Primary.....	AS-5670	Air Filter Primary.....	AS-5670	<b>PC228USLC-2</b> (EXCAVATORS) S6D102E	

MODEL/APPLICATION	SAKURA NO	MODEL/APPLICATION	SAKURA NO	MODEL/APPLICATION	SAKURA NO
<b>KOMATSU</b>		<b>KOMATSU</b>		<b>KOMATSU</b>	
<b>PC228USLC-2</b> (EXCAVATORS) S6D102E		Hydraulic Breather.....	H-56610	<b>PC240-3SER</b> (EXCAVATORS) S6D105-1	
Air Filter Set.....	AS-5672-S	Oil Filter Full Flow.....	C-5730	Air Filter Secondary.....	A-5635
Air Filter Secondary.....	A-5671	<b>PC230-6</b> (EXCAVATORS) SA6D95L-1/10001/10176		Air Filter Primary.....	A-5639
Air Filter Primary.....	AS-5670	Air Filter Primary.....	A-5639	Coolant Filter.....	WC-5707
Coolant Filter.....	WC-5707	Air Filter Secondary.....	A-5635	Hydraulic Oil Filter.....	H-5609
Hydraulic Oil Filter.....	H-85680	Hydraulic Oil Filter.....	H-7911	<b>PC240-5K</b> (EXCAVATORS)	
Hydraulic Oil Filter.....	H-5609	Hydraulic Oil Filter.....	H-85680	Air Filter Primary.....	AS-5670
Oil Filter Full Flow.....	C-5730	Hydraulic Breather.....	H-56610	Air Filter Set.....	AS-5672-S
<b>PC228USLC-3</b> (EXCAVATORS) SAA6D102E		Oil Filter Full Flow.....	C-5606	Air Filter Secondary.....	A-5671
Air Filter Secondary.....	A-8578	<b>PC230LC-6</b> (EXCAVATORS) SA6D95L-1/10001/111870		Fuel Filter.....	FC-5715
Air Filter Primary.....	A-8577	Air Filter Secondary.....	A-5635	Hydraulic Oil Filter.....	H-7911
Fuel Filter Secondary.....	FC-7903	Air Filter Primary.....	A-5639	Hydraulic Oil Filter.....	H-85680
Fuel/Water Separator.....	SFC-5708	Hydraulic Oil Filter.....	H-85680	Oil Filter Full Flow.....	C-5102
Hydraulic Oil Filter.....	H-5629	Hydraulic Oil Filter.....	H-7911	<b>PC240-6K</b> (EXCAVATORS)	
Hydraulic Oil Filter.....	H-5646	Hydraulic Breather.....	H-56610	Air Filter Set.....	AS-5672-S
Oil Filter Full Flow.....	C-5611	Oil Filter Full Flow.....	C-5606	Air Filter Secondary.....	A-5671
<b>PC228USLC-3E0</b> (EXCAVATORS) SAA6D107E-1		<b>PC230LC-6</b> (EXCAVATORS) SA6D102E-1/10177		Air Filter Primary.....	AS-5670
Fuel Filter.....	FC-5613	Air Filter Secondary.....	A-5635	Fuel Filter Secondary.....	FC-7903
Hydraulic Oil Filter.....	H-5629	Air Filter Primary.....	A-5639	Fuel/Water Separator.....	SFC-5708
Hydraulic Oil Filter.....	H-5646	Fuel Filter Secondary.....	FC-7903	Fuel/Water Separator.....	SFC-5706
Oil Filter Full Flow.....	C-5611	Fuel/Water Separator.....	SFC-5708	Hydraulic Oil Filter.....	H-7911
<b>PC228UU-1</b> (EXCAVATORS) S6D102E		Hydraulic Oil Filter.....	H-85680	Hydraulic Oil Filter.....	H-85680
Air Filter Primary.....	AS-5670	Hydraulic Breather.....	H-56610	<b>PC240-7</b> (EXCAVATORS) 2004	
Air Filter Set.....	AS-5672-S	Oil Filter Full Flow.....	C-5730	Oil Filter Full Flow.....	C-5610
Air Filter Secondary.....	A-5671	<b>PC230LC-6</b> (EXCAVATORS) SA6D95L-1/10001/10176		<b>PC240-8</b> (EXCAVATORS) 2006	
Coolant Filter.....	WC-5707	Air Filter Secondary.....	A-5635	Hydraulic Oil Filter.....	H-5646
Hydraulic Oil Filter.....	H-5609	Air Filter Primary.....	A-5639	Hydraulic Oil Filter.....	H-5629
Hydraulic Oil Filter.....	H-85680	Hydraulic Oil Filter.....	H-7911	<b>PC240LC</b> (EXCAVATORS) S6D102	
Oil Filter Full Flow.....	C-5730	Hydraulic Oil Filter.....	H-85680	Air Filter Primary.....	AS-5670
<b>PC230-6</b> (EXCAVATORS) KOMATSU SA6D95L		Hydraulic Breather.....	H-56610	Air Filter Set.....	AS-5672-S
Fuel Filter.....	FC-5601	Oil Filter Full Flow.....	C-5606	Coolant Filter.....	WC-5707
<b>PC230-6</b> (EXCAVATORS) S6D95L-1/20001/UP		<b>PC230NHD-7</b> (EXCAVATORS) SAA6D102E-2		Hydraulic Oil Filter.....	H-5609
Air Filter Primary.....	A-5639	Hydraulic Oil Filter.....	H-5646	<b>PC240LC-7</b> (EXCAVATORS)	
Hydraulic Oil Filter.....	H-7911	Hydraulic Oil Filter.....	H-5629	Cabin Air Filter.....	CA-56041
Hydraulic Oil Filter.....	H-85680	<b>PC230NHD-7K</b> (EXCAVATORS) SAA6D102E-2		<b>PC250LC-6</b> (EXCAVATORS) SA6D102-1/A82001	
Hydraulic Breather.....	H-56610	Hydraulic Oil Filter.....	H-5629	Fuel Filter Secondary.....	FC-7903
Oil Filter Full Flow.....	C-5606	Hydraulic Oil Filter.....	H-5646	Fuel/Water Separator.....	SFC-5706
<b>PC230-6</b> (EXCAVATORS) SA6D95L-1/10001/111870		<b>PC240</b> (EXCAVATORS)		Fuel/Water Separator.....	SFC-5708
Air Filter Secondary.....	A-5635	Air Filter Set.....	AS-5672-S	Hydraulic Oil Filter.....	H-7911
Air Filter Primary.....	A-5639	Air Filter Primary.....	AS-5670	Hydraulic Oil Filter.....	H-85680
Hydraulic Oil Filter.....	H-7911	Air Filter Secondary.....	A-5671	<b>PC25-1</b> (EXCAVATORS) 3D84N-2	
Hydraulic Oil Filter.....	H-85680	Fuel Filter.....	FC-5715	Air Filter Primary.....	AS-2205
Hydraulic Breather.....	H-56610	Hydraulic Oil Filter.....	H-85680	Fuel Filter.....	F-5210
Oil Filter Full Flow.....	C-5606	Hydraulic Oil Filter.....	H-7911	Hydraulic Oil Filter.....	H-5607
<b>PC230-6</b> (EXCAVATORS) SAG6D102E-1/10177		Oil Filter Full Flow.....	C-5102	Oil Filter Full Flow.....	C-8012
Air Filter Primary.....	A-5639	<b>PC240-3</b> (EXCAVATORS)		<b>PC25-1</b> (EXCAVATORS) 3D82E-3	
Air Filter Secondary.....	A-5635	Air Filter Primary.....	A-5639	Oil Filter Full Flow.....	C-8012
Fuel Filter Secondary.....	FC-7903	Hydraulic Oil Filter.....	H-5609	<b>PC25-1</b> (EXCAVATORS) 3D82E-3	
Fuel/Water Separator.....	SFC-5708	Oil Filter Full Flow.....	C-5608	Oil Filter Full Flow.....	C-8012
Hydraulic Oil Filter.....	H-85680				

# Sakura Filter

# ENGINE APPLICATION

MODEL/APPLICATION	SAKURA NO	MODEL/APPLICATION	SAKURA NO	MODEL/APPLICATION	SAKURA NO
<b>KOMATSU</b>		<b>KOMATSU</b>		<b>KOMATSU</b>	
<b>PC25-1</b> (EXCAVATORS) 3D82E-3/6471		<b>PC270LC-7MH</b> (EXCAVATORS) SAA6D102E		Air Filter Primary.....	A-8504
Fuel Filter.....	F-5210	Air Filter Secondary.....	A-5667	Fuel Filter.....	F-5207
Hydraulic Oil Filter.....	H-5607	Air Filter Primary.....	A-5666	Oil Filter Full Flow.....	C-5205
Oil Filter Full Flow.....	C-1011	Cabin Air Filter.....	CA-5602	Oil Filter Full Flow.....	C-8012
<b>PC25-1</b> (EXCAVATORS) 3D84N-2/1001/6470		Cabin Air Filter.....	CA-56041	<b>PC280-3</b> (EXCAVATORS) S/N: 10001	
Air Filter Primary.....	AS-2205	Fuel Filter.....	F-5218	Air Filter Primary.....	A-5639
Fuel Filter.....	F-5210	Hydraulic Oil Filter.....	H-5646	Hydraulic Oil Filter.....	H-5609
Hydraulic Oil Filter.....	H-5607	Hydraulic Oil Filter.....	H-5629	Oil Filter Full Flow.....	C-5608
Oil Filter Full Flow.....	C-1011	Hydraulic Breather.....	H-56610	<b>PC280-3SER</b> (EXCAVATORS) S6D110	
<b>PC25-8</b> (EXCAVATORS)		Oil Filter Full Flow.....	C-5611	Air Filter Primary.....	A-5639
Fuel Filter.....	F-5207	<b>PC270LC-8</b> (EXCAVATORS) SAA6D107E-1		Coolant Filter.....	WC-5707
Oil Filter Full Flow.....	C-1011	Air Filter Primary.....	A-5666	Hydraulic Oil Filter.....	H-5609
<b>PC25R-8</b> (EXCAVATORS) 3D82AE/10001		Air Filter Secondary.....	A-5667	<b>PC280LC-3</b> (EXCAVATORS) S6D110-1D/10001/55860	
Air Filter Primary.....	A-8504	Cabin Air Filter.....	CA-56041	Air Filter Primary.....	A-5639
Air Filter Primary.....	A-8513	Fuel Filter.....	FC-5613	Hydraulic Oil Filter.....	H-5609
Fuel Filter.....	F-5207	Hydraulic Oil Filter.....	H-5629	Oil Filter Full Flow.....	C-5608
Oil Filter Full Flow.....	C-8012	Hydraulic Oil Filter.....	H-5646	<b>PC28UU-1</b> (EXCAVATORS) YANMAR/1001	
Oil Filter Full Flow.....	C-5205	Hydraulic Breather.....	H-56610	Air Filter Primary.....	AS-2205
<b>PC25R-8</b> (EXCAVATORS) 3D82AE-3E/10001		Oil Filter Full Flow.....	C-5611	Fuel Filter.....	F-5210
Air Filter Primary.....	A-8513	<b>PC270LL-7</b> (EXCAVATORS) SAA6D102E		Oil Filter Full Flow.....	C-5708
Air Filter Primary.....	A-8504	Air Filter Primary.....	A-5666	<b>PC28UU-2</b> (EXCAVATORS) 3D82E-3/10801	
Fuel Filter.....	F-5207	Air Filter Secondary.....	A-5667	Air Filter Primary.....	AS-2205
Oil Filter Full Flow.....	C-8012	Cabin Air Filter.....	CA-5602	Fuel Filter.....	F-5207
Oil Filter Full Flow.....	C-5205	Cabin Air Filter.....	CA-56041	Oil Filter Full Flow.....	C-8012
<b>PC25R-8</b> (EXCAVATORS) 3D82AE-3F/10001		Fuel Filter.....	F-5218	<b>PC28UU-2</b> (EXCAVATORS) 3D84N-2/7001/10800	
Air Filter Primary.....	A-8513	Hydraulic Oil Filter.....	H-5629	Air Filter Primary.....	AS-2205
Air Filter Primary.....	A-8504	Hydraulic Oil Filter.....	H-5646	Fuel Filter.....	F-5210
Fuel Filter.....	F-5207	Hydraulic Breather.....	H-56610	Oil Filter Full Flow.....	C-8012
Oil Filter Full Flow.....	C-8012	Oil Filter Full Flow.....	C-5611	<b>PC290</b> (EXCAVATORS)	
Oil Filter Full Flow.....	C-5205	<b>PC27-8</b> (EXCAVATORS) 3D82AE-3F		Air Filter Secondary.....	A-5671
<b>PC25R-8</b> (EXCAVATORS) 3D82AE-3F/10001		Fuel Filter.....	F-5207	<b>PC290-7</b> (EXCAVATORS)	
Air Filter Primary.....	A-8513	Oil Filter Full Flow.....	C-1011	Air Filter Secondary.....	A-5667
Air Filter Primary.....	A-8504	<b>PC27MR-2</b> (EXCAVATORS) 3D82AE , 2005		Air Filter Primary.....	A-5666
Fuel Filter.....	F-5207	Air Filter Secondary.....	A-5569	Fuel Filter Secondary.....	FC-7903
Oil Filter Full Flow.....	C-8012	Air Filter Primary.....	A-8513	Fuel/Water Separator.....	SFC-5708
Oil Filter Full Flow.....	C-5205	Fuel Filter.....	F-5207	Hydraulic Oil Filter.....	H-5646
<b>PC270-7</b> (EXCAVATORS) SAA6D102E		Oil Filter Full Flow.....	C-8012	Hydraulic Oil Filter.....	H-5629
Air Filter Secondary.....	A-5667	<b>PC27R-8</b> (EXCAVATORS) 3D82AE/10001		Hydraulic Breather.....	H-56610
Air Filter Primary.....	A-5666	Air Filter Primary.....	A-8513	Oil Filter Full Flow.....	C-5730
Cabin Air Filter.....	CA-5602	Air Filter Primary.....	A-8504	<b>PC290-8</b> (EXCAVATORS) 2006	
Cabin Air Filter.....	CA-56041	Fuel Filter.....	F-5207	Air Filter Secondary.....	A-5667
Fuel Filter.....	F-5218	Oil Filter Full Flow.....	C-5205	Air Filter Primary.....	A-5666
Hydraulic Oil Filter.....	H-5646	Oil Filter Full Flow.....	C-8012	Hydraulic Oil Filter.....	H-5629
Hydraulic Oil Filter.....	H-5629	<b>PC27R-8</b> (EXCAVATORS) 3D82AE-3E/10001		Hydraulic Oil Filter.....	H-5646
Hydraulic Breather.....	H-56610	Air Filter Primary.....	A-8513	Hydraulic Oil Filter.....	H-5629
Oil Filter Full Flow.....	C-5611	Air Filter Primary.....	A-8504	Hydraulic Breather.....	H-56610
<b>PC270LC-6</b> (EXCAVATORS) SA6D102E		Fuel Filter.....	F-5207	Oil Filter Full Flow.....	C-5730
Hydraulic Oil Filter.....	H-85680	Oil Filter Full Flow.....	C-5205	<b>PC290-8</b> (EXCAVATORS) 2006	
<b>PC270LC-6LE</b> (EXCAVATORS) SA6D102E		Oil Filter Full Flow.....	C-8012	Air Filter Secondary.....	A-5667
Hydraulic Oil Filter.....	H-85680	<b>PC27R-8</b> (EXCAVATORS) 3D82AE-3F/10001		Air Filter Primary.....	A-5666
<b>PC270LC-6MH</b> (EXCAVATORS) SA6D102E		Air Filter Primary.....	A-8513	Hydraulic Oil Filter.....	H-5629
Hydraulic Oil Filter.....	H-85680	<b>PC27R-8</b> (EXCAVATORS) 3D82AE-3F/10001		<b>PC290-8</b> (EXCAVATORS) 2006	
<b>PC270LC-6MH</b> (EXCAVATORS) SA6D102E		Air Filter Primary.....	A-8513	Air Filter Secondary.....	A-5667
Hydraulic Oil Filter.....	H-85680	<b>PC27R-8</b> (EXCAVATORS) 3D82AE-3F/10001		Air Filter Primary.....	A-5666
<b>PC270LC-6MH</b> (EXCAVATORS) SA6D102E		Air Filter Primary.....	A-8513	Hydraulic Oil Filter.....	H-5629
Hydraulic Oil Filter.....	H-85680	<b>PC27R-8</b> (EXCAVATORS) 3D82AE-3F/10001			
		Air Filter Primary.....	A-8513		

# Sakura Filter

# ENGINE APPLICATION

MODEL/APPLICATION	SAKURA NO	MODEL/APPLICATION	SAKURA NO	MODEL/APPLICATION	SAKURA NO
<b>KOMATSU</b>		<b>KOMATSU</b>		<b>KOMATSU</b>	
<b>PC290-8</b> (EXCAVATORS) 2006		Cabin Air Filter.....	CA-56041	Hydraulic Oil Filter.....	H-5629
Hydraulic Oil Filter.....	H-5646	Hydraulic Oil Filter.....	H-5646	Hydraulic Oil Filter.....	H-5646
		Hydraulic Oil Filter.....	H-5629	Hydraulic Breather.....	H-56610
		Oil Filter Full Flow.....	C-5611	Oil Filter Full Flow.....	C-5611
<b>PC290LC-6K</b> (EXCAVATORS) SAA6D102EA-1/K30001-UP/21288263-UP		<b>PC240LC-8</b> (EXCAVATORS) KOMATSU SAA6D107E-1		<b>PC240-8K</b> (EXCAVATORS) SAA6D107E-1	
Fuel Filter Secondary.....	FC-7903	Hydraulic Oil Filter additional part..	H-7105	Air Filter Primary.....	A-5666
Fuel/Water Separator.....	SFC-5708			Air Filter Secondary.....	A-5667
Fuel/Water Separator.....	SFC-5706	<b>PC240LC-8</b> (EXCAVATORS) SAA6D107E-1		Cabin Air Filter.....	CA-56041
Hydraulic Oil Filter.....	H-85680	Air Filter Primary.....	A-5666	Fuel Filter.....	FC-5613
Hydraulic Oil Filter Suction.....	H-2706	Air Filter Secondary.....	A-5667	Hydraulic Oil Filter.....	H-5646
Hydraulic Breather.....	H-56610	Cabin Air Filter.....	CA-56041	Hydraulic Oil Filter.....	H-5629
		Fuel Filter.....	FC-5613	Hydraulic Breather.....	H-56610
<b>PC290NLC-6K</b> (EXCAVATORS)		Hydraulic Oil Filter.....	H-5629	Oil Filter Full Flow.....	C-5611
Cabin Air Filter Set.....	CA-5601-S	Hydraulic Oil Filter.....	H-5646		
Fuel Filter Secondary.....	FC-7903	Hydraulic Breather.....	H-56610	<b>PC240LC-10</b> (EXCAVATORS) SAA6D107E-2 , 2011	
Fuel/Water Separator.....	SFC-5706	Oil Filter Full Flow.....	C-5611	Air Filter Secondary.....	A-5667
Fuel/Water Separator.....	SFC-5708			Air Filter Primary.....	A-5666
Hydraulic Oil Filter.....	H-7911	<b>PC240LC-8K</b> (EXCAVATORS) SAA6D107E-1		Cabin Air Filter.....	CA-56041
Hydraulic Oil Filter.....	H-85680	Air Filter Secondary.....	A-5667	Hydraulic Oil Filter.....	H-5629
		Air Filter Primary.....	A-5666	Hydraulic Oil Filter.....	H-5646
<b>PC290NLC-7K</b> (EXCAVATORS) 2006		Cabin Air Filter.....	CA-56041	Oil Filter Full Flow.....	C-5611
Air Filter Primary.....	A-5666	Fuel Filter.....	FC-5613		
Cabin Air Filter.....	CA-56041	Hydraulic Oil Filter.....	H-5629	<b>PC240LC-10</b> (EXCAVATORS) SAA6D107E-2	
Fuel Filter Secondary.....	FC-7903	Hydraulic Oil Filter.....	H-5646	Cabin Air Filter.....	CAC-56120
Fuel/Water Separator.....	SFC-5708	Hydraulic Breather.....	H-56610	Cabin Air Filter.....	CA-56120
Hydraulic Oil Filter.....	H-5646	Oil Filter Full Flow.....	C-5611		
Hydraulic Oil Filter.....	H-5629			<b>PC240NLC-7</b> (EXCAVATORS) SAA6D102E-2 , 2005	
Hydraulic Breather.....	H-56610	<b>PC210-8K</b> (EXCAVATORS) KOMATSU SAA6D107E-1B-WK		Fuel Filter Secondary.....	FC-7903
Oil Filter Full Flow.....	C-5611	Hydraulic Oil Filter additional part..	H-7105	Fuel/Water Separator.....	SFC-5708
				Hydraulic Oil Filter.....	H-5629
<b>PC210NLC-7K</b> (EXCAVATORS) SAA6D102E , 2004		<b>PC210-8K</b> (EXCAVATORS) SAA6D107E-1		Hydraulic Oil Filter.....	H-5646
Air Filter Primary.....	A-8577	Air Filter Secondary.....	A-5667		
Air Filter Secondary.....	A-8578	Air Filter Primary.....	A-5666	<b>PC240NLC-8</b> (EXCAVATORS)	
Hydraulic Oil Filter.....	H-5629	Cabin Air Filter.....	CA-56041	Hydraulic Oil Filter.....	H-5629
Hydraulic Oil Filter.....	H-5646	Fuel Filter.....	FC-5613	Hydraulic Oil Filter.....	H-5646
Oil Filter Full Flow.....	C-5610	Hydraulic Oil Filter.....	H-5629		
		Hydraulic Oil Filter.....	H-5646	<b>PC240NLC-8K</b> (EXCAVATORS) SAA6D107E-1	
<b>PC210NLC-8K</b> (EXCAVATORS) SAA6D107E-1		Hydraulic Breather.....	H-56610	Air Filter Primary.....	A-5666
Air Filter Secondary.....	A-5667	Oil Filter Full Flow.....	C-5611	Air Filter Secondary.....	A-5667
Air Filter Primary.....	A-5666			Cabin Air Filter.....	CA-56041
Cabin Air Filter.....	CA-56041	<b>PC210LC-8</b> (EXCAVATORS) SAA6D107E , 2006		Fuel Filter.....	FC-5613
Fuel Filter.....	FC-5613	Air Filter Secondary.....	A-5667	Hydraulic Oil Filter.....	H-5629
Hydraulic Oil Filter.....	H-5629	Air Filter Primary.....	A-5666	Hydraulic Oil Filter.....	H-5646
Hydraulic Oil Filter.....	H-5646	Cabin Air Filter.....	CA-56041	Hydraulic Breather.....	H-56610
Hydraulic Breather.....	H-56610	Hydraulic Oil Filter.....	H-5629	Oil Filter Full Flow.....	C-5611
Oil Filter Full Flow.....	C-5611	Hydraulic Oil Filter.....	H-5646		
		Oil Filter Full Flow.....	C-5611	<b>PC270LC-7</b> (EXCAVATORS) SAA6D102E	
<b>PC228USLC-9</b> (EXCAVATORS) SAA6D107E-1K		<b>PC210LC-8K</b> (EXCAVATORS) KOMATSU SAA6D107E-1B-WK		Air Filter Secondary.....	A-5667
Air Filter Secondary.....	A-5667	Hydraulic Oil Filter additional part..	H-7105	Air Filter Primary.....	A-5666
Air Filter Primary.....	A-5666			Cabin Air Filter.....	CA-56041
Cabin Air Filter.....	CA-56041	<b>PC210LC-8K</b> (EXCAVATORS) SAA6D107E-1		Cabin Air Filter.....	CA-5602
Hydraulic Oil Filter.....	H-5629	Air Filter Secondary.....	A-5667	Fuel Filter.....	F-5218
Hydraulic Oil Filter.....	H-5646	Air Filter Primary.....	A-5666	Hydraulic Oil Filter.....	H-5629
Hydraulic Breather.....	H-56610	Cabin Air Filter.....	CA-56041	Hydraulic Oil Filter.....	H-5646
Oil Filter Full Flow.....	C-5611	Hydraulic Oil Filter.....	H-5629	Hydraulic Breather.....	H-56610
		Hydraulic Oil Filter.....	H-5646	Oil Filter Full Flow.....	C-5611
<b>PC230NHD-8</b> (EXCAVATORS) KOMATSU , 2007		Oil Filter Full Flow.....	C-5611		
Air Filter Secondary.....	A-5667	<b>PC210LC-8K</b> (EXCAVATORS) SAA6D107E-1		<b>PC270LC-7</b> (EXCAVATORS) SAA6D102E	
Air Filter Primary.....	A-5666	Air Filter Secondary.....	A-5667	Air Filter Secondary.....	A-5667
Cabin Air Filter.....	CA-56041	Air Filter Primary.....	A-5666	Air Filter Primary.....	A-5666
Hydraulic Oil Filter.....	H-5629	Cabin Air Filter.....	CA-56041	Cabin Air Filter.....	CA-56041
Hydraulic Oil Filter.....	H-5646	Fuel Filter.....	FC-5613	Cabin Air Filter.....	CA-5602
Oil Filter Full Flow.....	C-5611	Hydraulic Oil Filter.....	H-5629	Fuel Filter.....	F-5218
		Hydraulic Oil Filter.....	H-5646	Hydraulic Oil Filter.....	H-5629
		Oil Filter Full Flow.....	C-5611	Hydraulic Oil Filter.....	H-5646
				Hydraulic Breather.....	H-56610
				Oil Filter Full Flow.....	C-5611

MODEL/APPLICATION	SAKURA NO	MODEL/APPLICATION	SAKURA NO	MODEL/APPLICATION	SAKURA NO
<b>KOMATSU</b>		<b>KOMATSU</b>		<b>KOMATSU</b>	
<b>PC27MRX-1</b> (EXCAVATORS) 3D82AE , 2005 Air Filter Primary..... A-8513 Air Filter Secondary..... A-5569 Fuel Filter..... F-5207 Oil Filter Full Flow..... C-8012		<b>PC300</b> (EXCAVATORS) Air Filter Primary..... A-1313 Air Filter Set..... A-5662-S Air Filter Secondary..... A-1307 Fuel Filter..... FC-5602 Hydraulic Oil Filter..... H-7911 Hydraulic Oil Filter..... H-85680 Oil Filter Full Flow..... C-5608		<b>PC300-3</b> (EXCAVATORS) S6D125-1/12001/13137 Air Filter Secondary..... A-5408 Air Filter Primary..... A-6113 Fuel Filter..... FC-5602 Hydraulic Oil Filter..... H-5652 Hydraulic Oil Filter..... H-7911 Hydraulic Oil Filter..... H-85680 Oil Filter Full Flow..... C-5605 Oil Filter Full Flow..... C-5701 Oil Filter Full Flow..... C-5715	
<b>PC290LC-8K</b> (EXCAVATORS) SAA6D107E Air Filter Secondary..... A-5667 Air Filter Primary..... A-5666 Cabin Air Filter..... CA-56041 Fuel Filter..... FC-5613 Hydraulic Oil Filter..... H-5646 Hydraulic Oil Filter..... H-5629 Oil Filter Full Flow..... C-5611		<b>PC3000</b> (EXCAVATORS) CUMMINS KTA38 , 2007 Hydraulic Oil Filter..... H-62110		<b>PC300-3</b> (EXCAVATORS) S6D125-15/12239/13137 Air Filter Primary..... A-6113 Air Filter Secondary..... A-5408 Fuel Filter..... FC-5602 Hydraulic Oil Filter..... H-85680 Hydraulic Oil Filter..... H-7911 Oil Filter Full Flow..... C-5701 Oil Filter Full Flow..... C-5715 Oil Filter Full Flow..... C-5605	
<b>PC270-8</b> (EXCAVATORS) KOMATSU SAA6D107E-1E-W1 Hydraulic Oil Filter additional part.. H-7105		<b>PC3000</b> (EXCAVATORS) Hydraulic Oil Filter..... H-62110		<b>PC300-3</b> (EXCAVATORS) S6D125-15/12239/13137 Air Filter Primary..... A-6113 Air Filter Secondary..... A-5408 Fuel Filter..... FC-5602 Hydraulic Oil Filter..... H-85680 Hydraulic Oil Filter..... H-7911 Oil Filter Full Flow..... C-5701 Oil Filter Full Flow..... C-5715 Oil Filter Full Flow..... C-5605	
<b>PC270-8</b> (EXCAVATORS) SAA6D107E-1 Fuel Filter..... FC-5613		<b>PC300-1</b> (EXCAVATORS) NT-855 Air Filter Secondary..... A-5408 Air Filter Primary..... A-6113 Fuel Filter..... FC-5602 Hydraulic Oil Filter..... H-85680 Hydraulic Oil Filter..... H-7911 Oil Filter By Pass..... O-5704 Oil Filter Full Flow..... C-5701 Oil Filter Full Flow..... C-5715 Oil Filter Full Flow..... C-5605		<b>PC300-35ER</b> (EXCAVATORS) Air Filter Secondary..... A-5408 Air Filter Primary..... A-6113 Fuel Filter..... FC-5602 Hydraulic Oil Filter..... H-7911 Hydraulic Oil Filter..... H-85680 Hydraulic Oil Filter..... H-5652 Oil Filter Full Flow..... C-5715 Oil Filter Full Flow..... C-5605 Oil Filter Full Flow..... C-5701	
<b>PC290LC-10</b> (EXCAVATORS) SAA6D107E-2 Cabin Air Filter..... CA-56120 Cabin Air Filter..... CAC-56120		<b>PC300-15ER</b> (EXCAVATORS) Air Filter Secondary..... A-5408 Air Filter Primary..... A-6113 Coolant Filter..... WC-5707 Fuel Filter..... FC-5602 Hydraulic Oil Filter..... H-85680 Hydraulic Oil Filter..... H-7911 Oil Filter Full Flow..... C-5701 Oil Filter Full Flow..... C-5715 Oil Filter Full Flow..... C-5605 Oil Filter By Pass..... O-5704		<b>PC300-5</b> (EXCAVATORS) SA6D108/20001 Air Filter Secondary..... A-1307 Air Filter Primary..... A-1313 Air Filter Set..... A-5662-S Fuel Filter..... FC-5602 Hydraulic Oil Filter..... H-5652 Hydraulic Oil Filter..... H-7911 Hydraulic Oil Filter..... H-85680 Oil Filter Full Flow..... C-5608	
<b>PC230NHD-8K</b> (EXCAVATORS) SAA6D107E-1 Fuel Filter..... FC-5613		<b>PC300-25ER</b> (EXCAVATORS) Air Filter Primary..... A-6113 Air Filter Secondary..... A-5408 Coolant Filter..... WC-5707 Fuel Filter..... FC-5602 Hydraulic Oil Filter..... H-7911 Hydraulic Oil Filter..... H-85680 Oil Filter By Pass..... O-5704 Oil Filter Full Flow..... C-5715 Oil Filter Full Flow..... C-5701 Oil Filter Full Flow..... C-5605		<b>PC300-5</b> (EXCAVATORS) SA6D108-1/20001/10001 Air Filter Set..... A-5662-S Air Filter Secondary..... A-1307 Air Filter Primary..... A-1313 Fuel Filter..... FC-5602 Hydraulic Oil Filter..... H-5652 Hydraulic Oil Filter..... H-7911 Hydraulic Oil Filter..... H-85680 Oil Filter Full Flow..... C-5608	
<b>PC200-8M0</b> (EXCAVATORS) S/N: DBBB2001-UP Fuel/Water Separator..... SFC-56050		<b>PC300-25ER</b> (EXCAVATORS) Air Filter Primary..... A-6113 Air Filter Secondary..... A-5408 Coolant Filter..... WC-5707 Fuel Filter..... FC-5602 Hydraulic Oil Filter..... H-7911 Hydraulic Oil Filter..... H-85680 Oil Filter By Pass..... O-5704 Oil Filter Full Flow..... C-5715 Oil Filter Full Flow..... C-5701 Oil Filter Full Flow..... C-5605		<b>PC300-5</b> (EXCAVATORS) SA6D108-1/20001/10001 Air Filter Set..... A-5662-S Air Filter Secondary..... A-1307 Air Filter Primary..... A-1313 Fuel Filter..... FC-5602 Hydraulic Oil Filter..... H-5652 Hydraulic Oil Filter..... H-7911 Hydraulic Oil Filter..... H-85680 Oil Filter Full Flow..... C-5608	
<b>PC200-8M0</b> (EXCAVATORS) S/N: J60001-UP Fuel/Water Separator..... SFC-19100B Fuel/Water Separator..... SFC-56050		<b>PC300-25ER</b> (EXCAVATORS) Air Filter Primary..... A-6113 Air Filter Secondary..... A-5408 Coolant Filter..... WC-5707 Fuel Filter..... FC-5602 Hydraulic Oil Filter..... H-7911 Hydraulic Oil Filter..... H-85680 Oil Filter By Pass..... O-5704 Oil Filter Full Flow..... C-5715 Oil Filter Full Flow..... C-5701 Oil Filter Full Flow..... C-5605		<b>PC300-5</b> (EXCAVATORS) SA6D108-1/20001/10001 Air Filter Set..... A-5662-S Air Filter Secondary..... A-1307 Air Filter Primary..... A-1313 Fuel Filter..... FC-5602 Hydraulic Oil Filter..... H-5652 Hydraulic Oil Filter..... H-7911 Hydraulic Oil Filter..... H-85680 Oil Filter Full Flow..... C-5608	
<b>PC220-8M0</b> (EXCAVATORS) S/N: DBBG7001-UP Fuel/Water Separator..... SFC-56050		<b>PC300-3</b> (EXCAVATORS) S6D125-1 Fuel Filter..... FC-5606		<b>PC300-55ER</b> (EXCAVATORS) Air Filter Secondary..... A-1307	
<b>PC30</b> (EXCAVATORS) 3TN84E Air Filter Primary..... AS-1014 Hydraulic Oil Filter..... H-5607		<b>PC300-3</b> (EXCAVATORS) S6D125-1 Fuel Filter..... FC-5606			
<b>PC30</b> (EXCAVATORS) Air Filter Primary..... AS-2205 Fuel Filter..... F-5207 Hydraulic Oil Filter..... H-5607 Oil Filter Full Flow..... C-1920					
<b>PC300</b> (EXCAVATORS) N-855 Fuel Filter..... FC-5602 Hydraulic Oil Filter..... H-85680 Hydraulic Oil Filter..... H-7911 Oil Filter Full Flow..... C-5605 Oil Filter Full Flow..... C-5701 Oil Filter Full Flow..... C-5715					

MODEL/APPLICATION	SAKURA NO	MODEL/APPLICATION	SAKURA NO	MODEL/APPLICATION	SAKURA NO
<b>KOMATSU</b>		<b>KOMATSU</b>		<b>KOMATSU</b>	
<b>PC300-5SER</b> (EXCAVATORS)		Air Filter Primary.....	A-5558M	Air Filter Set.....	A-5662-S
Air Filter Primary.....	A-1313	Air Filter Secondary.....	A-5559	Air Filter Secondary.....	A-1307
Air Filter Set.....	A-5662-S	Fuel Filter.....	FC-5621	Fuel Filter.....	FC-5602
Fuel Filter.....	FC-5602	Fuel Filter.....	FC-5610	Hydraulic Oil Filter.....	H-7911
Hydraulic Oil Filter.....	H-7911	Fuel Filter.....	F-5218	Hydraulic Oil Filter.....	H-85680
Hydraulic Oil Filter.....	H-5652	Hydraulic Oil Filter.....	H-5646	Hydraulic Oil Filter.....	H-5652
Hydraulic Oil Filter.....	H-85680	Hydraulic Oil Filter.....	H-5629	Oil Filter Full Flow.....	C-5608
Oil Filter Full Flow.....	C-5608	Hydraulic Breather.....	H-56610		
<b>PC300-6</b> (EXCAVATORS) KOMATSU SAA6D108		<b>PC300-7</b> (EXCAVATORS) KOMATSU SAA6D114E		<b>PC300HD-6</b> (EXCAVATORS) SA6D114 , 2004	
Fuel Filter.....	FC-5610	Hydraulic Oil Filter additional part..	H-7105	Air Filter Set.....	A-1841-S
<b>PC300-6</b> (EXCAVATORS) SAA6D108E-2/30001/19030		<b>PC300-7</b> (EXCAVATORS) KOMATSU SAA6D114E-2A		Air Filter Primary.....	A-1013
Air Filter Secondary.....	A-1307	Fuel Filter.....	FC-5610	Air Filter Secondary.....	A-5631
Air Filter Primary.....	A-1313	<b>PC300-7</b> (EXCAVATORS) SAA6D114E		Air Filter Primary.....	A-10134
Air Filter Set.....	A-5662-S	Hydraulic Oil Filter.....	H-56690	Fuel Filter.....	FS-5601
Fuel Filter.....	FC-5602	<b>PC300-7</b> (EXCAVATORS) SAA6D114E-2A		Hydraulic Oil Filter.....	H-7911
Hydraulic Oil Filter.....	H-7911	Air Filter Primary.....	A-5558M	Hydraulic Oil Filter.....	H-85680
Hydraulic Oil Filter.....	H-85680	Air Filter Secondary.....	A-5559	Hydraulic Breather.....	H-56610
Hydraulic Oil Filter.....	H-85680	Air Filter Set.....	A-5558M-S	Oil Filter Full Flow.....	C-5614
Hydraulic Breather.....	H-56610	Cabin Air Filter.....	CA-56041		
Oil Filter Full Flow.....	C-5614	Cabin Air Filter.....	CA-5602	<b>PC300HD-6</b> (EXCAVATORS) SA6D114-1 , 2004	
<b>PC300-6</b> (EXCAVATORS) SAA6D108		Fuel Filter.....	F-5218	Air Filter Set.....	A-1841-S
Air Filter Secondary.....	A-1307	Hydraulic Oil Filter.....	H-5629	Air Filter Primary.....	A-1013
Air Filter Primary.....	A-1313	Hydraulic Oil Filter.....	H-5646	Air Filter Secondary.....	A-5631
Air Filter Set.....	A-5662-S	<b>PC300AV</b> (EXCAVATORS) SA6D108		Air Filter Primary.....	A-10134
Coolant Filter.....	WC-5705	Air Filter Primary.....	A-1313	Coolant Filter.....	WC-5705
Fuel Filter.....	FC-5602	Air Filter Set.....	A-5662-S	Fuel Filter.....	FS-5601
Hydraulic Oil Filter.....	H-7911	Air Filter Secondary.....	A-1307	Fuel/Water Separator.....	SFC-5708
Hydraulic Oil Filter.....	H-85680	Fuel Filter.....	FC-5602	Hydraulic Oil Filter.....	H-7911
Oil Filter Full Flow.....	C-5614	Hydraulic Oil Filter.....	H-85680	Hydraulic Oil Filter.....	H-85680
<b>PC300-6</b> (EXCAVATORS) SAA6D108E		Hydraulic Oil Filter.....	H-7911	Oil Filter Combination.....	C-7927
Air Filter Primary.....	A-1313	Oil Filter Full Flow.....	C-5608	<b>PC300HD-6MH</b> (EXCAVATORS) SA6D114-1 , 2004	
Air Filter Set.....	A-5662-S	<b>PC300AV</b> (EXCAVATORS) SAA6D108		Air Filter Primary.....	A-1013
Cabin Air Filter.....	CA-56130	Air Filter Primary.....	A-1313	Air Filter Secondary.....	A-5631
Fuel Filter.....	FC-5602	Air Filter Set.....	A-5662-S	Air Filter Primary.....	A-10134
Hydraulic Oil Filter.....	H-7911	Air Filter Secondary.....	A-1307	Air Filter Set.....	A-1841-S
Hydraulic Oil Filter.....	H-85680	Fuel Filter.....	FC-5602	Coolant Filter.....	WC-5705
<b>PC300-6</b> (EXCAVATORS) SAA6D108E-2A		Hydraulic Oil Filter.....	H-7911	Fuel Filter.....	FS-5601
Cabin Air Filter.....	CA-56070	Hydraulic Oil Filter.....	H-85680	Fuel/Water Separator.....	SFC-5708
Fuel Filter.....	FC-5606	Oil Filter Full Flow.....	C-5614	Hydraulic Oil Filter.....	H-7911
<b>PC300-6SER</b> (EXCAVATORS)		<b>PC300HD-5</b> (EXCAVATORS) SA6D108-1/10001		Hydraulic Oil Filter.....	H-85680
Air Filter Secondary.....	A-1307	Air Filter Primary.....	A-1313	Hydraulic Oil Filter.....	H-7911
Air Filter Primary.....	A-1313	Air Filter Set.....	A-5662-S	Hydraulic Oil Filter.....	H-85680
Air Filter Set.....	A-5662-S	Air Filter Secondary.....	A-1307	Hydraulic Oil Filter.....	H-5652
Fuel Filter.....	FC-5602	Fuel Filter.....	FC-5602	Oil Filter Full Flow.....	C-5608
Hydraulic Oil Filter.....	H-7911	Hydraulic Oil Filter.....	H-7911	<b>PC300HD-7</b> (EXCAVATORS) KOMATSU SAA6D114E-2A	
Hydraulic Oil Filter.....	H-85680	Hydraulic Oil Filter.....	H-85680	Fuel Filter.....	FC-5610
Hydraulic Breather.....	H-56610	Hydraulic Oil Filter.....	H-5652	<b>PC300HD-7</b> (EXCAVATORS) SAA6D114E-2A	
Oil Filter Full Flow.....	C-5614	Oil Filter Full Flow.....	C-5608	Air Filter Primary.....	A-5558M
<b>PC300-7</b> (EXCAVATORS) 2004		<b>PC300HD-5</b> (EXCAVATORS) SA6D108		Air Filter Secondary.....	A-5559
Air Filter Set.....	A-5558M-S	Air Filter Primary.....	A-1313	Air Filter Set.....	A-5558M-S
<b>PC300-7</b> (EXCAVATORS) SAA6D114E-2A		Air Filter Set.....	A-5662-S	Cabin Air Filter.....	CA-5602
Air Filter Set.....	A-5558M-S	Air Filter Secondary.....	A-1307	Cabin Air Filter.....	CA-56041
<b>PC300HD-6</b> (EXCAVATORS) SAA6D114E-2A		Fuel Filter.....	FC-5602	Fuel Filter.....	F-5218
Air Filter Set.....	A-1841-S	Hydraulic Oil Filter.....	H-7911	Hydraulic Oil Filter.....	H-5646
Air Filter Primary.....	A-1013	Hydraulic Oil Filter.....	H-85680	Hydraulic Oil Filter.....	H-5629
Air Filter Secondary.....	A-5631	Hydraulic Oil Filter.....	H-5652	<b>PC300HD-7L</b> (EXCAVATORS) KOMATSU SAA6D114E-2A	
Air Filter Primary.....	A-10134	Oil Filter Full Flow.....	C-5608	Fuel Filter.....	FC-5610
Fuel Filter.....	FS-5601	<b>PC300HD-5</b> (EXCAVATORS) SA6D108			
Hydraulic Oil Filter.....	H-7911	Air Filter Primary.....	A-1313		
Hydraulic Oil Filter.....	H-85680				
Oil Filter Combination.....	C-7927				

MODEL/APPLICATION	SAKURA NO	MODEL/APPLICATION	SAKURA NO	MODEL/APPLICATION	SAKURA NO
<b>KOMATSU</b>		<b>KOMATSU</b>		<b>KOMATSU</b>	
<b>PC300HD-7L</b> (EXCAVATORS) SAA6D114E-2A		Fuel Filter.....	FC-5602	Fuel/Water Separator.....	SFC-5708
Air Filter Set.....	A-5558M-S	Hydraulic Oil Filter.....	H-7911	Hydraulic Oil Filter.....	H-7911
Air Filter Primary.....	A-5558M	Hydraulic Oil Filter.....	H-85680	Hydraulic Oil Filter.....	H-85680
Air Filter Secondary.....	A-5559	Oil Filter Full Flow.....	C-5715	Oil Filter Combination.....	C-7927
Cabin Air Filter.....	CA-5602	Oil Filter Full Flow.....	C-5605		
Cabin Air Filter.....	CA-56041	Oil Filter Full Flow.....	C-5701		
Fuel Filter.....	F-5218			<b>PC300LC-6</b> (EXCAVATORS) KOMATSU SAA6D108	
Hydraulic Oil Filter.....	H-5646			Fuel Filter.....	FC-5610
Hydraulic Oil Filter.....	H-5629				
		<b>PC300LC-5</b> (EXCAVATORS) 614TA		<b>PC300LC-6</b> (EXCAVATORS) KOMATSU SAA6D108E-2	
<b>PC300HD-7MH</b> (EXCAVATORS) KOMATSU SAA6D114E-2A		Air Filter Primary.....	A-1313	Fuel Filter.....	FC-5601
Fuel Filter.....	FC-5610	Air Filter Set.....	A-5662-S		
		Air Filter Secondary.....	A-1307	<b>PC300LC-6</b> (EXCAVATORS) SAA6D108E-2/30001/19030	
<b>PC300HD-7MH</b> (EXCAVATORS) SAA6D114E-2A		Fuel Filter Secondary.....	FC-7903	Air Filter Set.....	A-5662-S
Air Filter Secondary.....	A-5559	Fuel/Water Separator.....	SFC-5706	Air Filter Secondary.....	A-1307
Air Filter Set.....	A-5558M-S	Fuel/Water Separator.....	SFC-5708	Air Filter Primary.....	A-1313
Air Filter Primary.....	A-5558M	Hydraulic Oil Filter.....	H-85680	Fuel Filter.....	FC-5602
Cabin Air Filter.....	CA-5602	Hydraulic Oil Filter.....	H-7911	Hydraulic Oil Filter.....	H-7911
Cabin Air Filter.....	CA-56041	Oil Filter Combination.....	C-5723	Hydraulic Oil Filter.....	H-85680
Fuel Filter.....	F-5218			Hydraulic Oil Filter.....	H-85680
Hydraulic Oil Filter.....	H-5629			Hydraulic Breather.....	H-56610
Hydraulic Oil Filter.....	H-5646			Oil Filter Full Flow.....	C-5614
		<b>PC300LC-5</b> (EXCAVATORS) SAA6D108/20001			
<b>PC300HD-8</b> (EXCAVATORS) SAA6D114E-3		Air Filter Set.....	A-5662-S	<b>PC300LC-6</b> (EXCAVATORS) SAA6D108	
Air Filter Secondary.....	A-8580	Air Filter Secondary.....	A-1307	Air Filter Set.....	A-5662-S
Air Filter Primary.....	A-8665M	Air Filter Primary.....	A-1313	Air Filter Secondary.....	A-1307
Cabin Air Filter.....	CA-56041	Fuel Filter.....	FC-5602	Air Filter Primary.....	A-1313
Fuel Filter.....	FC-5613	Hydraulic Oil Filter.....	H-85680	Coolant Filter.....	WC-5705
Hydraulic Oil Filter.....	H-5629	Hydraulic Oil Filter.....	H-7911	Fuel Filter.....	FC-5602
Hydraulic Oil Filter.....	H-5646	Hydraulic Oil Filter.....	H-5652	Hydraulic Oil Filter.....	H-85680
Hydraulic Breather.....	H-56610	Oil Filter Full Flow.....	C-5608	Hydraulic Oil Filter.....	H-7911
				Oil Filter Full Flow.....	C-5614
<b>PC300LC-2</b> (EXCAVATORS) NT-855		<b>PC300LC-5</b> (EXCAVATORS) SAA6D108-1/20001/10001		<b>PC300LC-6</b> (EXCAVATORS) SAA6D108E-2A	
Air Filter Secondary.....	A-5408	Air Filter Set.....	A-5662-S	Cabin Air Filter.....	CA-56070
Air Filter Primary.....	A-6113	Air Filter Secondary.....	A-1307	Fuel Filter.....	FC-5606
Fuel Filter.....	FC-5602	Air Filter Primary.....	A-1313		
Hydraulic Oil Filter.....	H-85680	Fuel Filter.....	FC-5602	<b>PC300LC-7L</b> (EXCAVATORS) KOMATSU SAA6D114E-2A	
Hydraulic Oil Filter.....	H-7911	Hydraulic Oil Filter.....	H-85680	Fuel Filter.....	FC-5610
Oil Filter Full Flow.....	C-5701	Hydraulic Oil Filter.....	H-7911		
Oil Filter Full Flow.....	C-5715	Hydraulic Oil Filter.....	H-5652	<b>PC300LC-7L</b> (EXCAVATORS) SAA6D114E-2A	
Oil Filter By Pass.....	O-5704	Oil Filter Full Flow.....	C-5608	Air Filter Primary.....	A-5558M
Oil Filter Full Flow.....	C-5605			Air Filter Secondary.....	A-5559
				Air Filter Set.....	A-5558M-S
<b>PC300LC-3</b> (EXCAVATORS) S6D125-1/12001/13137		<b>PC300LC-5</b> (EXCAVATORS) SAA6D108		Cabin Air Filter.....	CA-5602
Air Filter Primary.....	A-6113	Fuel Filter.....	FC-5606	Cabin Air Filter.....	CA-56041
Air Filter Secondary.....	A-5408			Fuel Filter.....	F-5218
Fuel Filter.....	FC-5602	<b>PC300LC-6</b> (EXCAVATORS) SAA6D114 , 2004		Hydraulic Oil Filter.....	H-5629
Hydraulic Oil Filter.....	H-85680	Air Filter Set.....	A-1841-S	Hydraulic Oil Filter.....	H-5646
Hydraulic Oil Filter.....	H-7911	Air Filter Secondary.....	A-5631		
Hydraulic Oil Filter.....	H-5652	Air Filter Primary.....	A-10134	<b>PC300LC-8</b> (EXCAVATORS) KOMATSU SAA6D114E-3D-WT	
Oil Filter Full Flow.....	C-5715	Air Filter Primary.....	A-1013	Hydraulic Oil Filter additional part.	H-7105
Oil Filter Full Flow.....	C-5701	Fuel Filter.....	FS-5601		
Oil Filter Full Flow.....	C-5605	Hydraulic Oil Filter.....	H-85680	<b>PC300LC-8</b> (EXCAVATORS) SAA6D114E-3	
		Hydraulic Oil Filter.....	H-7911	Air Filter Primary.....	A-8665M
<b>PC300LC-3</b> (EXCAVATORS) S6D125-1S/12239/13137		Oil Filter Combination.....	C-7927	Air Filter Secondary.....	A-8580
Air Filter Primary.....	A-6113			Cabin Air Filter.....	CA-56041
Air Filter Secondary.....	A-5408	<b>PC300LC-6</b> (EXCAVATORS) SAA6D114-1 , 2004		Fuel Filter.....	FC-5613
Fuel Filter.....	FC-5602	Air Filter Set.....	A-1841-S	Hydraulic Oil Filter.....	H-5635
Hydraulic Oil Filter.....	H-85680	Air Filter Secondary.....	A-5631		
Hydraulic Oil Filter.....	H-7911	Air Filter Primary.....	A-10134		
Hydraulic Oil Filter.....	H-5652	Air Filter Primary.....	A-1013		
Oil Filter Full Flow.....	C-5715	Fuel Filter.....	FS-5601		
Oil Filter Full Flow.....	C-5701	Hydraulic Oil Filter.....	H-7911		
Oil Filter Full Flow.....	C-5605	Oil Filter Combination.....	C-7927		
<b>PC300LC-3</b> (EXCAVATORS) S6D125-1S/12239/13137					
Air Filter Primary.....	A-6113				
Air Filter Secondary.....	A-5408				



MODEL/APPLICATION	SAKURA NO	MODEL/APPLICATION	SAKURA NO	MODEL/APPLICATION	SAKURA NO
<b>KOMATSU</b>		<b>KOMATSU</b>		<b>KOMATSU</b>	
<b>PC300LC-8</b> (EXCAVATORS) SAA6D114E-3		Oil Filter Full Flow.....	C-5605	<b>PC30R-8</b> (EXCAVATORS) 3D84E/10001	
Hydraulic Oil Filter.....	H-5646	Oil Filter Full Flow.....	C-5715	Air Filter Secondary.....	A-5569
Hydraulic Oil Filter.....	H-5629	<b>PC30-1</b> (EXCAVATORS) 3D75-1		Air Filter Primary.....	A-8513
Hydraulic Breather.....	H-56610	Hydraulic Oil Filter.....	H-5607	Fuel Filter.....	F-5210
<b>PC300LL-6</b> (EXCAVATORS) SA6D114-1 , 2004		<b>PC30-3</b> (EXCAVATORS) 3D75-1		Hydraulic Oil Filter.....	H-5607
Air Filter Primary.....	A-10134	Hydraulic Oil Filter.....	H-5607	Oil Filter Full Flow.....	C-1011
Air Filter Primary.....	A-1013	<b>PC30-5</b> (EXCAVATORS) 3D84-1/16001/13021		<b>PC30-SER</b> (EXCAVATORS)	
Air Filter Secondary.....	A-5631	Air Filter Primary.....	AS-2205	Fuel Filter.....	F-5207
Air Filter Set.....	A-1841-S	Fuel Filter.....	F-5207	Hydraulic Oil Filter.....	H-5607
Coolant Filter.....	WC-5705	Fuel Filter.....	F-5207	Oil Filter Full Flow.....	C-1920
Fuel Filter.....	FS-5601	Hydraulic Oil Filter.....	H-5607	<b>PC340</b> (EXCAVATORS)	
Fuel/Water Separator.....	SFC-5708	Oil Filter Full Flow.....	C-1920	Air Filter Breather.....	A-71330
Hydraulic Oil Filter.....	H-7911	<b>PC30-6</b> (EXCAVATORS) 3D84-1/10001		Air Filter Secondary.....	A-8580
Hydraulic Oil Filter.....	H-85680	Air Filter Primary.....	AS-2205	Fuel Filter Secondary.....	FC-7903
Oil Filter Combination.....	C-7927	Fuel Filter.....	F-5207	Fuel/Water Separator.....	SFC-5708
<b>PC300LL-7E0</b> (EXCAVATORS) SAA6D114E-3		Hydraulic Oil Filter.....	H-5607	Hydraulic Oil Filter.....	H-7911
Air Filter Primary.....	A-8665M	Oil Filter Full Flow.....	C-1920	Hydraulic Oil Filter.....	H-5629
Air Filter Secondary.....	A-8580	<b>PC30-7</b> (EXCAVATORS) 3D84E-3/26423		Hydraulic Oil Filter.....	H-85680
Cabin Air Filter.....	CA-56041	Fuel Filter.....	F-5210	Hydraulic Oil Filter.....	H-5646
Fuel Filter.....	FC-5613	Hydraulic Oil Filter.....	H-5607	Oil Filter Combination.....	C-5723
Hydraulic Oil Filter.....	H-5629	Oil Filter Full Flow.....	C-1011	<b>PC340-6</b> (EXCAVATORS)	
Hydraulic Oil Filter.....	H-5646	<b>PC30-7</b> (EXCAVATORS) 3D84-2/18001/26422		Air Filter Primary.....	A-10134
<b>PC300LL-7L</b> (EXCAVATORS) KOMATSU SAA6D114E-2A		Air Filter Primary.....	AS-2205	Air Filter Set.....	A-1841-S
Fuel Filter.....	FC-5610	Fuel Filter.....	F-5210	Air Filter Primary.....	A-1013
<b>PC300LL-7L</b> (EXCAVATORS) SAA6D114E-2A		Hydraulic Oil Filter.....	H-5607	Air Filter Secondary.....	A-5631
Air Filter Set.....	A-5558M-S	Oil Filter Full Flow.....	C-1011	Coolant Filter.....	WC-5712
Air Filter Primary.....	A-5558M	<b>PC30-8</b> (EXCAVATORS) 3D84E		Fuel/Water Separator.....	SFC-5708
Air Filter Secondary.....	A-5559	Air Filter Secondary.....	A-5569	<b>PC340-6 ACTIVE</b> (EXCAVATORS) 2000	
Cabin Air Filter.....	CA-56041	Air Filter Primary.....	A-8513	Fuel/Water Separator.....	SFC-5706
Cabin Air Filter.....	CA-5602	Fuel Filter.....	F-5210	<b>PC340-6K</b> (EXCAVATORS)	
Fuel Filter.....	F-5218	Hydraulic Oil Filter.....	H-5607	Air Filter Primary.....	A-10134
Hydraulic Oil Filter.....	H-5646	Oil Filter Full Flow.....	C-1011	Air Filter Set.....	A-1841-S
Hydraulic Oil Filter.....	H-5629	<b>PC308USLC-3</b> (EXCAVATORS) SAA6D107E		Air Filter Primary.....	A-1013
<b>PC300N-3</b> (EXCAVATORS) S6D125-1/13137		Air Filter Secondary.....	A-5667	Air Filter Secondary.....	A-5631
Air Filter Primary.....	A-6113	Air Filter Primary.....	A-5666	Fuel Filter Secondary.....	FC-7903
Air Filter Secondary.....	A-5408	Fuel Filter.....	FC-5613	Fuel/Water Separator.....	SFC-5708
Fuel Filter.....	FC-5602	Hydraulic Oil Filter.....	H-5629	Hydraulic Oil Filter.....	H-7911
Hydraulic Oil Filter.....	H-85680	Hydraulic Oil Filter.....	H-5646	Hydraulic Oil Filter.....	H-85680
Hydraulic Oil Filter.....	H-5652	<b>PC308USLC-3E0</b> (EXCAVATORS)		Hydraulic Breather.....	H-56610
Hydraulic Oil Filter.....	H-7911	Fuel Filter.....	FC-5613	Oil Filter Combination.....	C-5723
Oil Filter Full Flow.....	C-5701	Hydraulic Oil Filter.....	H-5629	<b>PC340-7</b> (EXCAVATORS) 2005	
Oil Filter Full Flow.....	C-5715	Hydraulic Oil Filter.....	H-5646	Air Filter.....	A-3320
Oil Filter Full Flow.....	C-5605	<b>PC30MRX-1</b> (EXCAVATORS) 3D84E		<b>PC340-7K</b> (EXCAVATORS) 2006	
<b>PC300NLC-3</b> (EXCAVATORS) S6D125-1/13137		Air Filter Primary.....	A-8513	Air Filter Set.....	A-5558M-S
Air Filter Secondary.....	A-5408	Fuel Filter.....	F-5207	Air Filter Primary.....	A-5558M
Air Filter Primary.....	A-6113	Oil Filter Full Flow.....	C-1011	Air Filter Secondary.....	A-5559
Fuel Filter.....	FC-5602	<b>PC300NLC-3</b> (EXCAVATORS) S6D125-1/13137		Fuel Filter.....	FC-5610
Hydraulic Oil Filter.....	H-85680	Air Filter Secondary.....	A-5408	Hydraulic Oil Filter.....	H-5629
Hydraulic Oil Filter.....	H-5652	Air Filter Primary.....	A-6113	Hydraulic Oil Filter.....	H-5646
Hydraulic Oil Filter.....	H-7911	Fuel Filter.....	FC-5602		
Oil Filter Full Flow.....	C-5701	Hydraulic Oil Filter.....	H-85680		
		Hydraulic Oil Filter.....	H-5652		
		Hydraulic Oil Filter.....	H-7911		
		Oil Filter Full Flow.....	C-5701		

# Sakura Filter

# ENGINE APPLICATION

MODEL/APPLICATION	SAKURA NO	MODEL/APPLICATION	SAKURA NO	MODEL/APPLICATION	SAKURA NO
<b>KOMATSU</b>		<b>KOMATSU</b>		<b>KOMATSU</b>	
<b>PC340-7K</b> (EXCAVATORS) 2006 Hydraulic Breather.....	H-56610	Fuel Filter.....	FC-5610	<b>PC350NLC- 8</b> (EXCAVATORS) KOMATSU , 2008 Air Filter Breather.....	A-71330
<b>PC340LC-6K</b> (EXCAVATORS) SAA6D114E-1/K30001-UP/21212392-UP Air Filter Primary.....	A-10134	<b>PC350-7</b> (EXCAVATORS) SAA6D114E-2A Hydraulic Oil Filter.....	H-5629	Hydraulic Oil Filter.....	H-5629
Air Filter Primary.....	A-1013	Hydraulic Oil Filter.....	H-5646	Hydraulic Oil Filter.....	H-5646
Air Filter Secondary.....	A-5631	<b>PC350-8K</b> (EXCAVATORS) 2008 Air Filter Secondary.....	A-8580	<b>PC35-8</b> (EXCAVATORS) 3D84E-3F Fuel Filter.....	F-5210
Air Filter Set.....	A-1841-S	Air Filter Breather.....	A-71330	Oil Filter Full Flow.....	C-1011
Fuel Filter Secondary.....	FC-7903	Air Filter Primary.....	A-8665M	<b>PC35MR-2</b> (EXCAVATORS) 3D88E Air Filter Secondary.....	A-5569
Fuel/Water Separator.....	SFC-5708	Cabin Air Filter.....	CA-56041	Air Filter Primary.....	A-8513
Hydraulic Oil Filter.....	H-7911	Hydraulic Oil Filter.....	H-56292	<b>PC35R-8</b> (EXCAVATORS) 3D84E/35001 Air Filter Secondary.....	A-5569
Hydraulic Oil Filter.....	H-85680	Hydraulic Breather.....	H-56610	Air Filter Primary.....	A-8513
Hydraulic Breather.....	H-56610	<b>PC350AV</b> (EXCAVATORS) SAA6D108 Air Filter Secondary.....	A-1307	<b>PC35MR-2</b> (EXCAVATORS) 3D88E Air Filter Secondary.....	A-5569
Oil Filter Combination.....	C-5723	Air Filter Primary.....	A-1313	Air Filter Primary.....	A-8513
<b>PC340NLC-7K</b> (EXCAVATORS) KOMATSU SAA6D114E-2A Fuel Filter.....	FC-5610	Air Filter Set.....	A-5662-S	Fuel Filter.....	F-5210
<b>PC340NLC-7K</b> (EXCAVATORS) SAA6D114E-2A Air Filter Primary.....	A-5558M	Fuel Filter.....	FC-5602	Hydraulic Oil Filter.....	H-5607
Air Filter Secondary.....	A-5559	Hydraulic Oil Filter.....	H-85680	Hydraulic Oil Filter.....	H-5607
Air Filter Set.....	A-5558M-S	Hydraulic Oil Filter.....	H-7911	Oil Filter Full Flow.....	C-1011
Cabin Air Filter.....	CA-56041	Oil Filter Full Flow.....	C-5614	<b>PC360-3</b> (EXCAVATORS) S/N: 10001 Air Filter Secondary.....	A-5408
Cabin Air Filter.....	CA-5602	<b>PC350LC-6</b> (EXCAVATORS) SAA6D108E-2/10001/19030 Air Filter Secondary.....	A-1307	Fuel Filter.....	FC-5602
Hydraulic Oil Filter.....	H-5646	Air Filter Primary.....	A-1313	Hydraulic Oil Filter.....	H-7911
Hydraulic Oil Filter.....	H-5629	Air Filter Set.....	A-5662-S	Hydraulic Oil Filter.....	H-85680
Hydraulic Breather.....	H-56610	Fuel Filter.....	FC-5602	Oil Filter Full Flow.....	C-5605
<b>PC35</b> (EXCAVATORS) 3TN84E Air Filter Primary.....	AS-1014	Hydraulic Oil Filter.....	H-85680	Oil Filter Full Flow.....	C-5715
Hydraulic Oil Filter.....	H-5607	Hydraulic Oil Filter.....	H-7911	Oil Filter Full Flow.....	C-5701
<b>PC350-6</b> (EXCAVATORS) SAA6D108E-2/10001/19030 Air Filter Set.....	A-5662-S	Hydraulic Breather.....	H-56610	<b>PC360-3SER</b> (EXCAVATORS) S6D125 Air Filter Secondary.....	A-5408
Air Filter Secondary.....	A-1307	Oil Filter Full Flow.....	C-5614	Air Filter Primary.....	A-6113
Air Filter Primary.....	A-1313	<b>PC350LC-6</b> (EXCAVATORS) SAA6D108 Fuel Filter.....	FC-5606	Fuel Filter.....	FC-5602
Fuel Filter.....	FC-5602	<b>PC350LC-7</b> (EXCAVATORS) KOMATSU SAA6D114E-2A Fuel Filter.....	FC-5610	Oil Filter Full Flow.....	C-5715
Hydraulic Oil Filter.....	H-85680	<b>PC350LC-7</b> (EXCAVATORS) SAA6D114E-2A Hydraulic Oil Filter.....	H-5646	Oil Filter Full Flow.....	C-5701
Hydraulic Oil Filter.....	H-7911	Hydraulic Oil Filter.....	H-5629	Oil Filter Full Flow.....	C-5605
Hydraulic Breather.....	H-56610	<b>PC350LC-8</b> (EXCAVATORS) KOMATSU , 2008 Air Filter Breather.....	A-71330	<b>PC360LC-5</b> (EXCAVATORS) Air Filter Set.....	A-5662-S
Oil Filter Full Flow.....	C-5614	Hydraulic Oil Filter.....	H-5646	Air Filter Primary.....	A-1313
<b>PC350-6</b> (EXCAVATORS) SAA6D108 Fuel Filter.....	FC-5606	Hydraulic Oil Filter.....	H-5629	Air Filter Secondary.....	A-1307
<b>PC350-6SER</b> (EXCAVATORS) Air Filter Secondary.....	A-1307	<b>PC350LC-8</b> (EXCAVATORS) KOMATSU SAA6D114E-3 Hydraulic Oil Filter.....	H-5635	Fuel Filter.....	FC-5602
Air Filter Primary.....	A-1313	Hydraulic Oil Filter.....	H-5629	Oil Filter Full Flow.....	C-5608
Air Filter Set.....	A-5662-S	<b>PC350LC-8</b> (EXCAVATORS) KOMATSU SAA6D114E-3D-WT Hydraulic Oil Filter additional part.	H-7105	<b>PC38</b> (EXCAVATORS) 3TN84E Air Filter Primary.....	AS-1014
Fuel Filter.....	FC-5602	<b>PC350LC-8</b> (EXCAVATORS) SAA6D114E-3 Fuel Filter.....	FC-5613	Hydraulic Oil Filter.....	H-5607
Hydraulic Oil Filter.....	H-85680	<b>PC350LC-8</b> (EXCAVATORS) SAA6D114E-3 Fuel Filter.....	FC-5613	<b>PC340LC-7K</b> (EXCAVATORS) KOMATSU SAA6D114E-2A Fuel Filter.....	FC-5610
Hydraulic Oil Filter.....	H-7911	<b>PC350LC-8</b> (EXCAVATORS) SAA6D114E-3 Fuel Filter.....	FC-5613	<b>PC340LC-7K</b> (EXCAVATORS) SAA6D114E-2A Air Filter Secondary.....	A-5559
Hydraulic Breather.....	H-56610	<b>PC350LC-8</b> (EXCAVATORS) SAA6D114E-3 Fuel Filter.....	FC-5613	Air Filter Set.....	A-5558M-S
Oil Filter Full Flow.....	C-5614	<b>PC350LC-8</b> (EXCAVATORS) SAA6D114E-3 Fuel Filter.....	FC-5613	Air Filter Primary.....	A-5558M
<b>PC350-7</b> (EXCAVATORS) KOMATSU SAA6D114E-2A		<b>PC350LC-8</b> (EXCAVATORS) SAA6D114E-3 Fuel Filter.....	FC-5613	Cabin Air Filter.....	CA-56041

MODEL/APPLICATION	SAKURA NO	MODEL/APPLICATION	SAKURA NO	MODEL/APPLICATION	SAKURA NO
<b>KOMATSU</b>		<b>KOMATSU</b>		<b>KOMATSU</b>	
<b>PC340LC-7K</b> (EXCAVATORS) SAA6D114E-2A		Cabin Air Filter.....	CA-56041	<b>PC400</b> (EXCAVATORS) S6D125	
Cabin Air Filter.....	CA-5602	<b>PC350-8</b> (EXCAVATORS) 2007		Air Filter Primary.....	A-10134
Hydraulic Oil Filter.....	H-5629	Air Filter Secondary.....	A-8580	Air Filter Set.....	A-1841-S
Hydraulic Oil Filter.....	H-5646	Air Filter Breather.....	A-71330	Air Filter Primary.....	A-1013
Hydraulic Breather.....	H-56610	Air Filter Primary.....	A-8665M	Air Filter Secondary.....	A-5631
<b>PC360-7</b> (EXCAVATORS) PC360-7		Cabin Air Filter.....	CA-56041	Fuel Filter.....	FC-5602
Fuel Filter.....	FC-5610	Fuel/Water Separator Secondary...	SFC-1905-10	Hydraulic Oil Filter.....	H-5609
<b>PC360-7</b> (EXCAVATORS) SAA6D114E		<b>PC350-8</b> (EXCAVATORS) KOMATSU SAA6D114E-3		Oil Filter Full Flow.....	C-5715
Air Filter Primary.....	A-5558M	Hydraulic Oil Filter.....	H-5635	Oil Filter Full Flow.....	C-5701
Air Filter Secondary.....	A-5559	<b>PC350-8</b> (EXCAVATORS) SAA6D114E-3		Oil Filter Full Flow.....	C-5605
Air Filter Set.....	A-5558M-S	Fuel Filter.....	FC-5613	<b>PC400</b> (EXCAVATORS) SA6D125	
Cabin Air Filter.....	CA-56041	Hydraulic Oil Filter.....	H-56690	Fuel Filter.....	FC-5602
Fuel Filter.....	FC-5621	<b>PC300-6Z</b> (EXCAVATORS) SAA6D108E-2A		Oil Filter Full Flow.....	C-5605
Hydraulic Oil Filter.....	H-5646	Cabin Air Filter.....	CA-56070	Oil Filter Full Flow.....	C-5701
Hydraulic Oil Filter.....	H-5629	Fuel Filter.....	FC-5606	Oil Filter Full Flow.....	C-5715
<b>PC300-8</b> (EXCAVATORS) KOMATSU SAA6D114E-3D-WT		<b>PC300LC-6Z</b> (EXCAVATORS) SAA6D108E-2A		<b>PC4000</b> (EXCAVATORS) CUMMINS KTA38 , 2007	
Hydraulic Oil Filter additional part..	H-7105	Cabin Air Filter.....	CA-56070	Hydraulic Oil Filter.....	H-62110
<b>PC300-8</b> (EXCAVATORS) SAA6D114E-3		Fuel Filter.....	FC-5606	<b>PC4000</b> (EXCAVATORS) KTA38 , 2007	
Air Filter Secondary.....	A-8580	<b>PC300-5K</b> (EXCAVATORS) SA6D108-1A		Oil Filter Full Flow.....	C-5715
Air Filter Primary.....	A-8665M	Fuel Filter.....	FC-5606	<b>PC400-1</b> (EXCAVATORS) NT-855	
Cabin Air Filter.....	CA-56041	<b>PC300-8M0</b> (EXCAVATORS) S/N: 80001-ON		Air Filter Secondary.....	A-5610
Fuel Filter.....	FC-5613	Fuel/Water Separator.....	SFC-56050	Fuel Filter.....	FC-5602
Hydraulic Oil Filter.....	H-56292	<b>PC300-8M0</b> (EXCAVATORS) S/N: J40001-UP		Hydraulic Oil Filter.....	H-7911
Hydraulic Oil Filter.....	H-56690	Fuel/Water Separator.....	SFC-56050	Hydraulic Oil Filter.....	H-85680
Hydraulic Oil Filter.....	H-5635	<b>PC300LC-8M0</b> (EXCAVATORS) S/N: 80001-ON		Oil Filter By Pass.....	O-5704
Hydraulic Breather.....	H-56610	Fuel/Water Separator.....	SFC-56050	Oil Filter Full Flow.....	C-5701
<b>PC300LC-7</b> (EXCAVATORS) KOMATSU SAA6D114E-2A		<b>PC300LC-8M0</b> (EXCAVATORS) S/N: 80001-ON		Oil Filter Full Flow.....	C-5715
Fuel Filter.....	FC-5610	Fuel/Water Separator.....	SFC-56050	Oil Filter Full Flow.....	C-5605
<b>PC300LC-7</b> (EXCAVATORS) SAA6D114E-2A		<b>PC350-8M0</b> (EXCAVATORS) S/N: 80001-ON		<b>PC400-1SER</b> (EXCAVATORS)	
Air Filter Secondary.....	A-5559	Fuel/Water Separator.....	SFC-56050	Air Filter Secondary.....	A-5610
Air Filter Set.....	A-5558M-S	<b>PC350-8M0</b> (EXCAVATORS) S/N: 80001-ON		Air Filter Primary.....	A-5618
Air Filter Primary.....	A-5558M	Fuel/Water Separator.....	SFC-56050	Coolant Filter.....	WC-5707
Cabin Air Filter.....	CA-56041	<b>PC350LC-8M0</b> (EXCAVATORS) S/N: 80001-ON		Fuel Filter.....	FC-5602
Cabin Air Filter.....	CA-5602	Fuel/Water Separator.....	SFC-56050	Hydraulic Oil Filter.....	H-7911
Fuel Filter.....	F-5218	<b>PC30MR-5</b> (EXCAVATORS) S/N: 50001-UP		Hydraulic Oil Filter.....	H-85680
Hydraulic Oil Filter.....	H-5629	Hydraulic Oil Filter.....	H-56110	Oil Filter Full Flow.....	C-5605
Hydraulic Oil Filter.....	H-5646	<b>PC35MR-5</b> (EXCAVATORS) S/N: 30001-UP		Oil Filter Full Flow.....	C-5701
<b>PC300LC-7E0</b> (EXCAVATORS) SAA6D114E-3		Hydraulic Oil Filter.....	H-56110	Oil Filter Full Flow.....	C-5715
Air Filter Primary.....	A-8665M	<b>PC40</b> (EXCAVATORS) 4TNE84		Oil Filter By Pass.....	O-5704
Air Filter Secondary.....	A-8580	Air Filter Primary.....	AS-1014	Oil Filter Full Flow.....	C-5701
Cabin Air Filter.....	CA-56041	Hydraulic Oil Filter.....	H-5607	Oil Filter Full Flow.....	C-5715
Fuel Filter.....	FC-5613	<b>PC40</b> (EXCAVATORS)		<b>PC400-3</b> (EXCAVATORS) S6D125	
Hydraulic Oil Filter.....	H-5629	Air Filter Primary.....	AS-2205	Air Filter Secondary.....	A-5610
Hydraulic Oil Filter.....	H-5646	Fuel Filter.....	F-5210	Air Filter Primary.....	A-5618
<b>PC340LC-7E0</b> (EXCAVATORS) S/N: K45001-UP		<b>PC40</b> (EXCAVATORS)		Fuel Filter.....	FC-5602
Air Filter Secondary.....	A-8580	Air Filter Primary.....	AS-2205	Hydraulic Oil Filter.....	H-7911
Air Filter Breather.....	A-71330	Fuel Filter.....	F-5210	Hydraulic Oil Filter.....	H-85680
Air Filter Primary.....	A-8665M			Oil Filter Full Flow.....	C-5605

# Sakura Filter

# ENGINE APPLICATION

MODEL/APPLICATION	SAKURA NO	MODEL/APPLICATION	SAKURA NO	MODEL/APPLICATION	SAKURA NO
<b>KOMATSU</b>		<b>KOMATSU</b>		<b>KOMATSU</b>	
<b>PC400-3 (EXCAVATORS) S6D125-1/11001/13444</b>		<b>PC400-5 (EXCAVATORS) S6D125-1VV</b>		<b>PC400HD-5 (EXCAVATORS) S6D125-1VV</b>	
Air Filter Secondary.....	A-5408	Fuel Filter.....	FC-5606	Air Filter Primary.....	A-10134
Air Filter Primary.....	A-6113			Air Filter Secondary.....	A-5631
Fuel Filter.....	FC-5602	<b>PC400-6 (EXCAVATORS) SA6D125E</b>		Air Filter Primary.....	A-1013
Hydraulic Oil Filter.....	H-5652	Air Filter Primary.....	A-6113	Air Filter Set.....	A-1841-S
Hydraulic Oil Filter.....	H-7911	Air Filter Secondary.....	A-5408	Fuel Filter.....	FC-5602
Hydraulic Oil Filter.....	H-85680	Fuel Filter.....	FC-5602	Fuel Filter.....	FC-5606
Oil Filter Full Flow.....	C-5605	Hydraulic Oil Filter.....	H-2709	Hydraulic Oil Filter.....	H-5652
Oil Filter Full Flow.....	C-5701	Oil Filter Full Flow.....	C-5701	Hydraulic Oil Filter.....	H-5609
Oil Filter Full Flow.....	C-5715	Oil Filter Full Flow.....	C-5715	Oil Filter Full Flow.....	C-5605
		Oil Filter Full Flow.....	C-5605	Oil Filter Full Flow.....	C-5715
				Oil Filter Full Flow.....	C-5701
<b>PC400-3 (EXCAVATORS) S6D125-1T</b>		<b>PC400-6 (EXCAVATORS) SA6D125E-2/30001/60721</b>		<b>PC400HD-5K (EXCAVATORS) 20001</b>	
Fuel Filter.....	FC-5606	Air Filter Primary.....	A-6113	Air Filter Primary.....	A-1013
		Air Filter Secondary.....	A-5408	Air Filter Secondary.....	A-5631
<b>PC400-3 (EXCAVATORS) S6D125-1T/11455/17974</b>		Fuel Filter.....	FC-5602	Air Filter Primary.....	A-10134
Fuel Filter.....	FC-5602	Hydraulic Oil Filter.....	H-2709	Air Filter Set.....	A-1841-S
Hydraulic Oil Filter.....	H-7911	Hydraulic Breather.....	H-56610	Fuel Filter.....	FC-5602
Hydraulic Oil Filter.....	H-85680	Oil Filter Full Flow.....	C-5701	Hydraulic Oil Filter.....	H-5609
Oil Filter Full Flow.....	C-5715	Oil Filter Full Flow.....	C-5715	Oil Filter Full Flow.....	C-5715
Oil Filter Full Flow.....	C-5605	Oil Filter Full Flow.....	C-5605	Oil Filter Full Flow.....	C-5605
Oil Filter Full Flow.....	C-5701			Oil Filter Full Flow.....	C-5701
		<b>PC400-6 (EXCAVATORS) SA6D125E</b>		<b>PC400HD-6 (EXCAVATORS) KOMATSU SA6D125E-2</b>	
<b>PC400-3SER (EXCAVATORS)</b>		Air Filter Primary.....	A-6113	Fuel Filter.....	FC-5610
Air Filter Primary.....	A-6113	Air Filter Secondary.....	A-5408		
Air Filter Secondary.....	A-5408	Fuel Filter.....	FC-5602	<b>PC400HD-6 (EXCAVATORS) M11</b>	
Fuel Filter.....	FC-5602	Hydraulic Oil Filter.....	H-2709	Air Filter Primary.....	A-5425
Hydraulic Oil Filter.....	H-7911	Oil Filter Full Flow.....	C-5715	Hydraulic Oil Filter.....	H-5609
Hydraulic Oil Filter.....	H-5652	Oil Filter Full Flow.....	C-5701	Oil Filter Combination.....	C-5723
Hydraulic Oil Filter.....	H-85680	Oil Filter Full Flow.....	C-5605		
Oil Filter Full Flow.....	C-5701			<b>PC400HD-6 (EXCAVATORS) SA6D125E-2</b>	
Oil Filter Full Flow.....	C-5605	<b>PC400-7 (EXCAVATORS)</b>		Hydraulic Oil Filter.....	H-2709
Oil Filter Full Flow.....	C-5715	Air Filter Breather.....	A-92040	Oil Filter Full Flow.....	C-5605
		Fuel/Water Separator Secondary..	SFC-5611-10B	Oil Filter Full Flow.....	C-5715
		Fuel/Water Separator Secondary..	SFC-5611-10	Oil Filter Full Flow.....	C-5701
		Hydraulic Oil Filter.....	H-5639		
<b>PC400-5 (EXCAVATORS) S6D125-1VV/20001</b>		<b>PC400-7 (EXCAVATORS) SA6D125E-5</b>		<b>PC400HD-6MLM (EXCAVATORS) KOMATSU SA6D125E-2</b>	
Air Filter Primary.....	A-1013	Air Filter Secondary.....	A-8580	Fuel Filter.....	FC-5610
Air Filter Secondary.....	A-5631	Air Filter Primary.....	A-8665M		
Air Filter Primary.....	A-10134	Cabin Air Filter.....	CA-56041	<b>PC400HD-6MLM (EXCAVATORS) SA6D125E-2</b>	
Air Filter Set.....	A-1841-S	Fuel/Water Separator Secondary..	SFC-5611-10B	Hydraulic Oil Filter.....	H-2709
Fuel Filter.....	FC-5602	Fuel/Water Separator Secondary..	SFC-5611-10	Oil Filter Full Flow.....	C-5605
Hydraulic Oil Filter.....	H-5609			Oil Filter Full Flow.....	C-5701
Hydraulic Oil Filter.....	H-5652	<b>PC400HD-5 (EXCAVATORS) S6D125-1/35323</b>		Oil Filter Full Flow.....	C-5715
Oil Filter Full Flow.....	C-5605	Air Filter Secondary.....	A-5631		
Oil Filter Full Flow.....	C-5715	Air Filter Set.....	A-1841-S	<b>PC400LC-1 (EXCAVATORS) NT-855</b>	
Oil Filter Full Flow.....	C-5701	Air Filter Primary.....	A-10134	Air Filter Secondary.....	A-5610
		Air Filter Primary.....	A-1013	Fuel Filter.....	FC-5602
		Fuel Filter.....	FC-5602	Hydraulic Oil Filter.....	H-85680
		Hydraulic Oil Filter.....	H-5652	Hydraulic Oil Filter.....	H-7911
		Hydraulic Oil Filter.....	H-5609	Oil Filter Full Flow.....	C-5715
		Oil Filter Full Flow.....	C-5715	Oil Filter Full Flow.....	C-5701
		Oil Filter Full Flow.....	C-5701	Oil Filter Full Flow.....	C-5605
		Oil Filter Full Flow.....	C-5605	Oil Filter By Pass.....	O-5704

MODEL/APPLICATION	SAKURA NO	MODEL/APPLICATION	SAKURA NO	MODEL/APPLICATION	SAKURA NO
<b>KOMATSU</b>		<b>KOMATSU</b>		<b>KOMATSU</b>	
<b>PC400LC-3</b> (EXCAVATORS) S6D125-1/11001/13444		Air Filter Secondary.....	A-5408	Air Filter Primary.....	A-8665M
Air Filter Secondary.....	A-5408	Fuel Filter.....	FC-5602	Cabin Air Filter.....	CA-56041
Air Filter Primary.....	A-6113	Hydraulic Oil Filter.....	H-2709	Fuel/Water Separator Secondary..	SFC-5611-10
Fuel Filter.....	FC-5602	Oil Filter Full Flow.....	C-5701	Fuel/Water Separator Secondary..	SFC-5611-10B
Hydraulic Oil Filter.....	H-85680	Oil Filter Full Flow.....	C-5715		
Hydraulic Oil Filter.....	H-5652	Oil Filter Full Flow.....	C-5605	<b>PC400LC-7MH</b> (EXCAVATORS) SAA6D125E	
Hydraulic Oil Filter.....	H-7911			Air Filter Secondary.....	A-8580
Oil Filter Full Flow.....	C-5701	<b>PC400LC-6</b> (EXCAVATORS) SAA6D125E-2/30001/60721		Air Filter Primary.....	A-8665M
Oil Filter Full Flow.....	C-5715	Air Filter Primary.....	A-6113	Hydraulic Oil Filter.....	H-5639
Oil Filter Full Flow.....	C-5605	Air Filter Secondary.....	A-5408		
		Fuel Filter.....	FC-5602	<b>PC400LC-8</b> (EXCAVATORS) SAA6D125E-5	
<b>PC400LC-3</b> (EXCAVATORS) S6D125-1T		Hydraulic Oil Filter.....	H-2709	Air Filter Breather.....	A-82010
Fuel Filter.....	FC-5606	Hydraulic Breather.....	H-56610	Air Filter Secondary.....	A-8580
		Oil Filter Full Flow.....	C-5605	Air Filter Primary.....	A-8665M
<b>PC400LC-3</b> (EXCAVATORS) S6D125-1T/11455/17974		Oil Filter Full Flow.....	C-5701	Cabin Air Filter.....	CA-56041
Fuel Filter.....	FC-5602	Oil Filter Full Flow.....	C-5715	Fuel Filter.....	FC-5614
Hydraulic Oil Filter.....	H-7911			Fuel Filter.....	FC-56230
Hydraulic Oil Filter.....	H-85680	<b>PC400LC-6</b> (EXCAVATORS) SAA6D125E		Fuel/Water Separator Secondary..	SFC-5611-10B
Oil Filter Full Flow.....	C-5701	Air Filter Secondary.....	A-5408	Fuel/Water Separator Secondary..	SFC-5611-10
Oil Filter Full Flow.....	C-5605	Air Filter Primary.....	A-6113	Hydraulic Oil Filter.....	H-5635
Oil Filter Full Flow.....	C-5715	Fuel Filter.....	FC-5602	Hydraulic Breather.....	H-56610
		Hydraulic Oil Filter.....	H-2709		
<b>PC400LC-5</b> (EXCAVATORS) S6D125-1VV/20001		Oil Filter Full Flow.....	C-5715	<b>PC40-1</b> (EXCAVATORS) 3D84-1	
Air Filter Primary.....	A-1013	Oil Filter Full Flow.....	C-5605	Air Filter Primary.....	AS-5620
Air Filter Set.....	A-1841-S	Oil Filter Full Flow.....	C-5701	Air Filter Secondary.....	A-5621
Air Filter Primary.....	A-10134			Air Filter Primary.....	AS-1014
Air Filter Secondary.....	A-5631	<b>PC400LC-6MH</b> (EXCAVATORS) SAA6D125E		Fuel Filter.....	FC-5604
Fuel Filter.....	FC-5602	Air Filter Primary.....	A-6113	Hydraulic Oil Filter.....	H-5607
Hydraulic Oil Filter.....	H-5652	Air Filter Secondary.....	A-5408	Oil Filter Full Flow.....	C-5606
Hydraulic Oil Filter.....	H-5609	Fuel Filter.....	FC-5602		
Oil Filter Full Flow.....	C-5701	Hydraulic Oil Filter.....	H-2709	<b>PC40-1</b> (EXCAVATORS) 3D94-2	
Oil Filter Full Flow.....	C-5715	Oil Filter Full Flow.....	C-5605	Fuel Filter.....	FC-5604
Oil Filter Full Flow.....	C-5605	Oil Filter Full Flow.....	C-5701	Hydraulic Oil Filter.....	H-5607
		Oil Filter Full Flow.....	C-5715	Oil Filter Full Flow.....	C-5606
<b>PC400LC-5</b> (EXCAVATORS) S6D125-1/20001/35323					
Air Filter Set.....	A-1841-S	<b>PC400LC-6MH</b> (EXCAVATORS) SAA6D125E		<b>PC40-2</b> (EXCAVATORS) 3D84-1	
Air Filter Primary.....	A-10134	Air Filter Primary.....	A-6113	Air Filter Primary.....	AS-5620
Air Filter Primary.....	A-1013	Air Filter Secondary.....	A-5408	Air Filter Primary.....	AS-1014
Air Filter Secondary.....	A-5631	Fuel Filter.....	FC-5602	Air Filter Secondary.....	A-5621
Fuel Filter.....	FC-5602	Hydraulic Oil Filter.....	H-2709	Fuel Filter.....	FC-5604
Hydraulic Oil Filter.....	H-5652	Oil Filter Full Flow.....	C-5605	Hydraulic Oil Filter.....	H-5607
Hydraulic Oil Filter.....	H-5609	Oil Filter Full Flow.....	C-5701	Oil Filter Full Flow.....	C-5606
Oil Filter Full Flow.....	C-5715	Oil Filter Full Flow.....	C-5715		
Oil Filter Full Flow.....	C-5605			<b>PC40-2</b> (EXCAVATORS) 3D94-2	
Oil Filter Full Flow.....	C-5701	<b>PC400LC-7</b> (EXCAVATORS) KOMATSU SAA6D125E-3K-8W		Fuel Filter.....	FC-5604
		Fuel/Water Separator.....	SFC-56020	Hydraulic Oil Filter.....	H-5607
<b>PC400LC-5</b> (EXCAVATORS) S6D125-1VV		Fuel/Water Separator.....	SFC-56020B	Oil Filter Full Flow.....	C-5606
Fuel Filter.....	FC-5606				
		<b>PC400LC-7</b> (EXCAVATORS) SAA6D125E		<b>PC40-3</b> (EXCAVATORS) 3D84-1	
<b>PC400LC-6</b> (EXCAVATORS) M11		Air Filter Primary.....	A-8665M	Air Filter Primary.....	AS-5620
Air Filter Primary.....	A-5425	Air Filter Secondary.....	A-8580	Air Filter Primary.....	AS-1014
Hydraulic Oil Filter.....	H-5609	Hydraulic Oil Filter.....	H-5639	Air Filter Secondary.....	A-5621
Oil Filter Combination.....	C-5723			Fuel Filter.....	FC-5604
		<b>PC400LC-7E0</b> (EXCAVATORS) KOMATSU SAA6D125E-5		Hydraulic Oil Filter.....	H-5607
<b>PC400LC-6</b> (EXCAVATORS) SAA6D125E		Hydraulic Oil Filter additional part..	H-7105	Oil Filter Full Flow.....	C-5606
Air Filter Primary.....	A-6113				
		<b>PC400LC-7E0</b> (EXCAVATORS) SAA6D125E-5		<b>PC40-3</b> (EXCAVATORS) 3D94-2	
		Air Filter Secondary.....	A-8580		

MODEL/APPLICATION	SAKURA NO	MODEL/APPLICATION	SAKURA NO	MODEL/APPLICATION	SAKURA NO
<b>KOMATSU</b>		<b>KOMATSU</b>		<b>KOMATSU</b>	
<b>PC40-3</b> (EXCAVATORS) 3D94-2		Fuel Filter.....	FC-5602	<b>PC450-6SER</b> (EXCAVATORS)	
Fuel Filter.....	FC-5604	Hydraulic Oil Filter.....	H-5609	Fuel Filter.....	FC-5602
Hydraulic Oil Filter.....	H-5607	Oil Filter Full Flow.....	C-5701	Hydraulic Oil Filter.....	H-2709
Oil Filter Full Flow.....	C-5606	Oil Filter Full Flow.....	C-5605	Hydraulic Breather.....	H-56610
		Oil Filter Full Flow.....	C-5715	Oil Filter Full Flow.....	C-5605
<b>PC40-5</b> (EXCAVATORS) 3D95S-W-1/8501/10467/13617		<b>PC45</b> (EXCAVATORS) 4TNE84		Oil Filter Full Flow.....	C-5701
Air Filter Primary.....	AS-2205	Air Filter Primary.....	AS-5620	Oil Filter Full Flow.....	C-5715
Fuel Filter.....	FC-5604	Air Filter Primary.....	AS-1014		
Hydraulic Oil Filter.....	H-5607	Hydraulic Oil Filter.....	H-5607	<b>PC450-7</b> (EXCAVATORS) 20066 , 2004	
		Hydraulic Oil Filter.....	H-5608	Air Filter Secondary.....	A-8580
<b>PC40-5</b> (EXCAVATORS) 3D95S-W-1/8501/13618		<b>PC450/7E0</b> (EXCAVATORS) SAA6D125E-5		Air Filter Primary.....	A-8665M
Air Filter Primary.....	AS-2205	Air Filter Primary.....	A-8665M	Cabin Air Filter.....	CA-56041
Fuel Filter.....	FC-5604	Air Filter Secondary.....	A-8580	Cabin Air Filter.....	CA-5602
Hydraulic Oil Filter.....	H-5607	Cabin Air Filter.....	CA-56041	Fuel/Water Separator Secondary..	SFC-5611-10
		Fuel/Water Separator Secondary..	SFC-5611-10	Fuel/Water Separator Secondary..	SFC-5611-10B
<b>PC40-6</b> (EXCAVATORS) 3D95S-W-1C/10001/10467/13617		Fuel/Water Separator Secondary..	SFC-5611-10B	Hydraulic Oil Filter.....	H-5639
Air Filter Primary.....	AS-2205	<b>PC450-6</b> (EXCAVATORS) SAG6D125E-2/10001/60721			
Fuel Filter.....	FC-5604	Air Filter Primary.....	A-6113	<b>PC450-7</b> (EXCAVATORS)	
Hydraulic Oil Filter.....	H-5607	Air Filter Secondary.....	A-5408	Air Filter Secondary.....	A-8580
		Fuel Filter.....	FC-5602	Air Filter Primary.....	A-8665M
<b>PC40-6</b> (EXCAVATORS) 3D95S-W-1C/10001/13618		Hydraulic Oil Filter.....	H-2709	Cabin Air Filter.....	CA-5602
Air Filter Primary.....	AS-2205	Hydraulic Breather.....	H-56610	Cabin Air Filter.....	CA-56041
Fuel Filter.....	FC-5604	Oil Filter Full Flow.....	C-5605	Fuel/Water Separator Secondary..	SFC-5611-10
Hydraulic Oil Filter.....	H-5607	Oil Filter Full Flow.....	C-5715	Fuel/Water Separator Secondary..	SFC-5611-10B
		Oil Filter Full Flow.....	C-5701	Hydraulic Breather.....	H-56610
<b>PC40-7</b> (EXCAVATORS) 4D84E-3/24522		Oil Filter Full Flow.....	C-5701	<b>PC450-7K</b> (EXCAVATORS) SAA6D125E-3K	
Air Filter Primary.....	AS-2205	<b>PC450-6K</b> (EXCAVATORS) MTA11 , 2012		Air Filter Set.....	A-5558M-S
Fuel Filter.....	F-5210	Coolant Filter.....	WC-5713	Air Filter Primary.....	A-5558M
Hydraulic Oil Filter.....	H-5607	Hydraulic Oil Filter.....	H-2709	Air Filter Secondary.....	A-5559
Oil Filter Full Flow.....	C-1011	Oil Filter Combination.....	C-5723	Cabin Air Filter.....	CA-56041
		<b>PC450-6K</b> (EXCAVATORS) SAG6D125E-2A , 2012		Fuel/Water Separator Secondary..	SFC-5611-10
<b>PC40-7</b> (EXCAVATORS) 4D84-2/18001/24521		Air Filter Secondary.....	A-5408	Fuel/Water Separator Secondary..	SFC-5611-10B
Air Filter Primary.....	AS-2205	Air Filter Primary.....	A-6113	Hydraulic Breather.....	H-56610
Fuel Filter.....	F-5210	Fuel Filter.....	FC-5602	<b>PC450-8</b> (EXCAVATORS) SAA6D125E-5	
Hydraulic Oil Filter.....	H-5607	Hydraulic Oil Filter.....	H-2709	Fuel Filter.....	FC-56230
Oil Filter Full Flow.....	C-1011	Oil Filter Full Flow.....	C-5715	Fuel Filter.....	FC-5614
		Oil Filter Full Flow.....	C-5701	<b>PC450-8</b> (EXCAVATORS) SAA6D125E-5F	
<b>PC40-8</b> (EXCAVATORS)		Oil Filter Full Flow.....	C-5605	Air Filter Secondary.....	A-8580
Fuel Filter.....	F-5210	<b>PC450-6K</b> (EXCAVATORS) SAA6D125E-2C , 2012		Air Filter Primary.....	A-8665M
Oil Filter Full Flow.....	C-1011	Air Filter Secondary.....	A-5408	Cabin Air Filter.....	CA-56041
		Air Filter Primary.....	A-6113	Hydraulic Oil Filter.....	H-5639
<b>PC40MRX-1</b> (EXCAVATORS)		Fuel Filter.....	FC-5602	Hydraulic Breather.....	H-56610
Oil Filter Full Flow.....	C-8012	Hydraulic Oil Filter.....	H-2709	<b>PC450LC-6</b> (EXCAVATORS) SAG6D125E-2/10001/60721	
		Oil Filter Full Flow.....	C-5715	Air Filter Primary.....	A-6113
<b>PC40R-8</b> (EXCAVATORS) 4D84E-3D/30001		Oil Filter Full Flow.....	C-5701	Air Filter Secondary.....	A-5408
Air Filter Secondary.....	A-5569	Oil Filter Full Flow.....	C-5605	Fuel Filter.....	FC-5602
Fuel Filter.....	F-5210	<b>PC450-6K</b> (EXCAVATORS)		Hydraulic Oil Filter.....	H-2709
Hydraulic Oil Filter.....	H-5607	Coolant Filter.....	WC-5713	Hydraulic Breather.....	H-56610
Oil Filter Full Flow.....	C-1011	Hydraulic Oil Filter.....	H-85680	Oil Filter Full Flow.....	C-5605
		Hydraulic Oil Filter.....	H-7911	Oil Filter Full Flow.....	C-5701
<b>PC410AV</b> (EXCAVATORS) S6D125		Oil Filter Combination.....	C-5723	Oil Filter Full Flow.....	C-5715
Air Filter Primary.....	A-10134				
Air Filter Set.....	A-1841-S				
Air Filter Primary.....	A-1013				
Air Filter Secondary.....	A-5631				

MODEL/APPLICATION	SAKURA NO	MODEL/APPLICATION	SAKURA NO	MODEL/APPLICATION	SAKURA NO
<b>KOMATSU</b>		<b>KOMATSU</b>		<b>KOMATSU</b>	
<b>PC450LC-6K</b> (EXCAVATORS) MTA11 , 2012		<b>PC450LC-8</b> (EXCAVATORS) KOMATSU SAA6D125E-5F-02		Cabin Air Filter.....	CA-56120
Coolant Filter.....	WC-5713	Hydraulic Oil Filter additional part..	H-7105	Cabin Air Filter.....	CAC-56120
Hydraulic Oil Filter.....	H-2709	<b>PC450LC-8</b> (EXCAVATORS) SAA6D125E-5F		<b>PC400-8R</b> (EXCAVATORS) KOMATSU SAA6D125E-5	
Oil Filter Combination.....	C-5723	Air Filter Secondary.....	A-8580	Cabin Air Filter.....	CA-56080
<b>PC450LC-6K</b> (EXCAVATORS) SAA6D125E-2C , 2012		Air Filter Primary.....	A-8665M	<b>PC50UU-1</b> (EXCAVATORS) 1001	
Air Filter Secondary.....	A-5408	Cabin Air Filter.....	CA-56041	Air Filter Primary.....	AS-1014
Air Filter Primary.....	A-6113	Hydraulic Oil Filter.....	H-5639	Fuel Filter.....	FC-5604
Fuel Filter.....	FC-5602	<b>PC450LCHD-8</b> (EXCAVATORS) SAA6D125E-5F		Hydraulic Oil Filter.....	H-5607
Hydraulic Oil Filter.....	H-2709	Air Filter Primary.....	A-8665M	<b>PC50UU-2</b> (EXCAVATORS) 4D84-2GA/12772 - 14992	
Oil Filter Full Flow.....	C-5605	Air Filter Secondary.....	A-8580	Air Filter Primary.....	AS-2205
Oil Filter Full Flow.....	C-5701	Cabin Air Filter.....	CA-56041	Fuel Filter.....	F-5210
Oil Filter Full Flow.....	C-5715	Hydraulic Oil Filter.....	H-5639	Hydraulic Oil Filter.....	H-5607
<b>PC450LC-6K</b> (EXCAVATORS)		<b>PC45MR-3</b> (EXCAVATORS) 4D88E		Oil Filter Full Flow.....	C-1011
Fuel Filter.....	FC-5621	Air Filter Primary.....	A-8505	<b>PC50UU-2</b> (EXCAVATORS) 4D84-2GA/8001 - 12771	
Oil Filter Combination.....	C-5723	Air Filter Secondary.....	A-8599	Air Filter Primary.....	AS-2205
<b>PC45-1</b> (EXCAVATORS) 4D84-2/1001/3505/1001		<b>PC45MR-3</b> (EXCAVATORS) YANMAR 4D88E		Fuel Filter.....	F-5210
Air Filter Primary.....	AS-2205	Hydraulic Oil Filter.....	H-56540	Hydraulic Oil Filter.....	H-5607
Fuel Filter.....	F-5210	<b>PC400-8</b> (EXCAVATORS) SAA6D125E-5		Oil Filter Full Flow.....	C-1011
Hydraulic Oil Filter.....	H-5607	Air Filter Secondary.....	A-8580	<b>PC50UU-2</b> (EXCAVATORS) 4D88E-3B/14993	
Oil Filter Full Flow.....	C-1011	Air Filter Primary.....	A-8665M	Air Filter Primary.....	AS-2205
<b>PC45-1</b> (EXCAVATORS) 4D84E-3/3506		Cabin Air Filter.....	CA-56041	Fuel Filter.....	F-5210
Air Filter Primary.....	AS-2205	Fuel/Water Separator Secondary... SFC-5611-10		Hydraulic Oil Filter.....	H-5607
Fuel Filter.....	F-5210	Fuel/Water Separator Secondary.. SFC-5611-10B		Oil Filter Full Flow.....	C-1011
Hydraulic Oil Filter.....	H-5607	Hydraulic Oil Filter.....	H-5635	<b>PC50UU-2</b> (EXCAVATORS) 4D88E-3B/8001 - 12771	
Oil Filter Full Flow.....	C-1011	Hydraulic Breather.....	H-56610	Air Filter Primary.....	AS-2205
<b>PC45-8</b> (EXCAVATORS) 4D84E-3D		<b>PC450-8R</b> (EXCAVATORS) SAA6D125E-5F		Fuel Filter.....	F-5210
Fuel Filter.....	F-5210	Air Filter Secondary.....	A-8580	Hydraulic Oil Filter.....	H-5607
Oil Filter Full Flow.....	C-1011	Air Filter Primary.....	A-8665M	Oil Filter Full Flow.....	C-1011
<b>PC45R-8</b> (EXCAVATORS) 4D84E-3D/5001		Cabin Air Filter.....	CA-56041	<b>PC50UU-2</b> (EXCAVATORS) 4D84-2	
Air Filter Secondary.....	A-5569	Hydraulic Oil Filter.....	H-5639	Air Filter Primary.....	AS-2205
Air Filter Primary.....	A-8513	<b>PC450LC-7</b> (EXCAVATORS) KOMATSU , 2005		Fuel Filter.....	F-5210
Fuel Filter.....	F-5210	Air Filter Primary.....	A-8579M	Hydraulic Oil Filter.....	H-5607
Hydraulic Oil Filter.....	H-5607	Air Filter Secondary.....	A-8580	Oil Filter Full Flow.....	C-8012
Oil Filter Full Flow.....	C-8012	Air Filter Set.....	A-8579M-S	<b>PC50UU-2</b> (EXCAVATORS) 4D84-2GA/14993	
<b>PC40MR-2</b> (EXCAVATORS) 4D88E , 2005		Fuel/Water Separator Secondary.. SFC-5611-10B		Air Filter Primary.....	AS-2205
Fuel Filter.....	FC-1016	Fuel/Water Separator Secondary... SFC-5611-10		Fuel Filter.....	F-5210
<b>PC40MR-2</b> (EXCAVATORS) 4D88E		Hydraulic Oil Filter.....	H-5639	Hydraulic Oil Filter.....	H-5607
Hydraulic Oil Filter.....	H-56540	Hydraulic Breather.....	H-56610	Oil Filter Full Flow.....	C-1011
<b>PC450LC-7K</b> (EXCAVATORS) SAA6D125E-3K		<b>PC490-10</b> (EXCAVATORS) SAA6D125E-6		<b>PC50UU-2</b> (EXCAVATORS) 4D88E-3B/12772/14992	
Air Filter Primary.....	A-5558M	Cabin Air Filter.....	CAC-56120	Air Filter Primary.....	AS-2205
Air Filter Secondary.....	A-5559	Cabin Air Filter.....	CA-56120	Fuel Filter.....	F-5210
Air Filter Set.....	A-5558M-S	<b>PC490LC-10</b> (EXCAVATORS) SAA6D125E-6		Hydraulic Oil Filter.....	H-5607
Cabin Air Filter.....	CA-56041	Cabin Air Filter.....	CAC-56120	Oil Filter Full Flow.....	C-1011
Fuel/Water Separator Secondary.. SFC-5611-10B		Cabin Air Filter.....	CA-56120	<b>PC50UU-2</b> (EXCAVATORS) 4D88E-3C/12772/14992	
Fuel/Water Separator Secondary... SFC-5611-10		<b>PC490LC-11</b> (EXCAVATORS) SAA6D125E-7		Air Filter Primary.....	AS-2205
Hydraulic Breather.....	H-56610			Fuel Filter.....	F-5210
				Hydraulic Oil Filter.....	H-5607

MODEL/APPLICATION	SAKURA NO	MODEL/APPLICATION	SAKURA NO	MODEL/APPLICATION	SAKURA NO
<b>KOMATSU</b>		<b>KOMATSU</b>		<b>KOMATSU</b>	
PC50UU-2 (EXCAVATORS) 4D88E-3C/12772/14992 Oil Filter Full Flow.....	C-1011	PC600 (EXCAVATORS) N14 , 2004 Air Filter Primary.....	A-6113	Hydraulic Oil Filter.....	H-5607
PC50UU-2 (EXCAVATORS) 4D88E-3C/14993 Air Filter Primary.....	AS-2205	Air Filter Secondary.....	A-5408	Oil Filter Full Flow.....	C-5606
Fuel Filter.....	F-5210	Coolant Filter.....	WC-5707	PC60-1-SER (EXCAVATORS) 4D95L-1 Fuel Filter.....	FC-5604
Hydraulic Oil Filter.....	H-5607	Fuel/Water Separator.....	SFC-5709-10	Hydraulic Oil Filter.....	H-5607
Oil Filter Full Flow.....	C-1011	Fuel/Water Separator.....	SFC-5509-10	Oil Filter Full Flow.....	C-5606
PC50UU-2 (EXCAVATORS) 4D88E-3C/8001/12771 Air Filter Primary.....	AS-2205	Hydraulic Oil Filter.....	H-7911	PC60-2 (EXCAVATORS) 4D94-2 Fuel Filter.....	FC-5604
Fuel Filter.....	F-5210	Hydraulic Oil Filter.....	H-85680	Hydraulic Oil Filter.....	H-5607
Hydraulic Oil Filter.....	H-5607	Oil Filter Combination.....	C-5723	Oil Filter Full Flow.....	C-5606
Oil Filter Full Flow.....	C-1011	PC600 (EXCAVATORS) CUMMINS N14 Air Filter Secondary.....	A-5408	PC60-2 (EXCAVATORS) 4D94-3 Fuel Filter.....	FC-5604
PC5500-6 (EXCAVATORS) SSA12V159 Air Filter Secondary.....	A-7902	Air Filter Primary.....	A-6113	Hydraulic Oil Filter.....	H-5607
Coolant Filter.....	WC-5713	PC600-7K (EXCAVATORS) 2006 Air Filter Secondary.....	A-8580	Oil Filter Full Flow.....	C-5606
Coolant Filter.....	WC-5703	Air Filter Primary.....	A-8665M	PC60-2-SER (EXCAVATORS) 4D94-2 Fuel Filter.....	FC-5604
PC50MR-2 (EXCAVATORS) 4D88E , 2005 Fuel Filter.....	FC-1016	Fuel/Water Separator Secondary... SFC-5611-10		Hydraulic Oil Filter.....	H-5607
PC50MR-2 (EXCAVATORS) 4D88E Hydraulic Oil Filter.....	H-56540	Fuel/Water Separator Secondary.. SFC-5611-10B		Oil Filter Full Flow.....	C-5606
PC55MR-3 (EXCAVATORS) 4D88E , 2011 Air Filter Primary.....	A-8505	Hydraulic Breather.....	H-56610	PC60-2-SER (EXCAVATORS) 4D94-3 Fuel Filter.....	FC-5604
Air Filter Secondary.....	A-8599	PC600LC-6 (EXCAVATORS) CUMMINS N14 Fuel/Water Separator.....	SFC-5709-10	Hydraulic Oil Filter.....	H-5607
PC55MR-3 (EXCAVATORS) YANMAR 4D88E Hydraulic Oil Filter.....	H-56540	PC600LC-6 (EXCAVATORS) N14 Air Filter Primary.....	A-6010	Oil Filter Full Flow.....	C-5606
PC58UU-3 (EXCAVATORS) 4D88E Air Filter Secondary.....	A-5569	Air Filter Secondary.....	A-6011	PC60-2-SER (EXCAVATORS) 4D95L-1 Fuel Filter.....	FC-5604
Air Filter Primary.....	A-8513	Coolant Filter.....	WC-5705	Hydraulic Oil Filter.....	H-5607
Hydraulic Oil Filter.....	H-5607	Fuel/Water Separator Secondary... SFC-1905-10		Oil Filter Full Flow.....	C-5606
PC56-7 (EXCAVATORS) S4D87E-1 Fuel Filter.....	FC-56310	Fuel/Water Separator..... SFC-5709-10		PC60-3 (EXCAVATORS) 4D95L-1 Fuel Filter.....	FC-5604
PC60 (EXCAVATORS) 4D94-2D Air Filter Primary.....	AS-1014	Fuel/Water Separator..... SFC-5705		Hydraulic Oil Filter.....	H-5607
Fuel Filter.....	FC-5604	Hydraulic Oil Filter.....	H-2709	Oil Filter Full Flow.....	C-5606
Hydraulic Oil Filter.....	H-5607	Oil Filter Combination.....	C-5723	PC60-3-SER (EXCAVATORS) 4D94-2 Fuel Filter.....	FC-5604
Oil Filter Full Flow.....	C-5606	PC60-1 (EXCAVATORS) 4D94-2 Fuel Filter.....	FC-5604	Hydraulic Oil Filter.....	H-5607
PC60 (EXCAVATORS) 4D95L Air Filter Primary.....	AS-1014	Hydraulic Oil Filter.....	H-5607	Oil Filter Full Flow.....	C-5606
Fuel Filter.....	FC-5604	Oil Filter Full Flow.....	C-5606	PC60-3-SER (EXCAVATORS) 4D94-3 Fuel Filter.....	FC-5604
Hydraulic Oil Filter.....	H-5607	PC60-1-SER (EXCAVATORS) 4D94-2 Fuel Filter.....	FC-5604	Hydraulic Oil Filter.....	H-5607
PC600 (EXCAVATORS) CUMMINS N14 , 2004 Fuel/Water Separator.....	SFC-5709-10	Hydraulic Oil Filter.....	H-5607	Oil Filter Full Flow.....	C-5606
PC600-1-SER (EXCAVATORS) 4D94-3 Fuel Filter.....	FC-5604	Oil Filter Full Flow.....	C-5606	PC60-3-SER (EXCAVATORS) 4D95L-1 Fuel Filter.....	FC-5604
PC60-1 (EXCAVATORS) 4D94-2 Fuel Filter.....	FC-5604	PC60-1-SER (EXCAVATORS) 4D94-3 Fuel Filter.....	FC-5604	Hydraulic Oil Filter.....	H-5607
Hydraulic Oil Filter.....	H-5607	Hydraulic Oil Filter.....	H-5607	Oil Filter Full Flow.....	C-5606
Oil Filter Full Flow.....	C-5606	Oil Filter Full Flow.....	C-5606	PC60-5 (EXCAVATORS) 4D95L-1K	



MODEL/APPLICATION	SAKURA NO	MODEL/APPLICATION	SAKURA NO	MODEL/APPLICATION	SAKURA NO
<b>KOMATSU</b>		<b>KOMATSU</b>		<b>KOMATSU</b>	
<b>PC60-5</b> (EXCAVATORS) 4D95L-1K		<b>PC60L-2</b> (EXCAVATORS) 4D94-2		Oil Filter Full Flow.....	C-5715
Air Filter Primary.....	AS-1014	Fuel Filter.....	FC-5604	<b>PC650-1</b> (EXCAVATORS) CUMMINS KT-1150	
Fuel Filter.....	FC-5604	Hydraulic Oil Filter.....	H-5607	Fuel Filter.....	FC-5606
Hydraulic Oil Filter.....	H-5607	Oil Filter Full Flow.....	C-5606	<b>PC650-1</b> (EXCAVATORS) KT-1150/10007/117097	
Oil Filter Full Flow.....	C-5604	<b>PC60L-2</b> (EXCAVATORS) 4D94-3		Air Filter Secondary.....	A-5408
<b>PC60-5</b> (EXCAVATORS) 4D95L-1/20501/13144		Fuel Filter.....	FC-5604	Air Filter Primary.....	A-6113
Air Filter Primary.....	AS-1014	Hydraulic Oil Filter.....	H-5607	Fuel Filter.....	FC-5602
Fuel Filter.....	FC-5604	Oil Filter Full Flow.....	C-5606	Fuel Filter.....	FC-5720
Hydraulic Oil Filter.....	H-5607	<b>PC60L-5</b> (EXCAVATORS) 4D95L-1K		Fuel/Water Separator.....	SFC-5705
Oil Filter Full Flow.....	C-5604	Air Filter Primary.....	AS-1014	Hydraulic Oil Filter.....	H-5652
<b>PC60-5-SER</b> (EXCAVATORS)		Fuel Filter.....	FC-5604	Hydraulic Oil Filter.....	H-7911
Air Filter Primary.....	AS-1014	Hydraulic Oil Filter.....	H-5607	Hydraulic Oil Filter.....	H-85680
Fuel Filter.....	FC-5604	Oil Filter Full Flow.....	C-5604	Hydraulic Oil Filter.....	HC-5601
Hydraulic Oil Filter.....	H-5607	<b>PC60U-5</b> (EXCAVATORS) 4D95L-1K		Oil Filter By Pass.....	O-5704
Oil Filter Full Flow.....	C-5604	Air Filter Primary.....	AS-1014	Oil Filter Full Flow.....	C-5715
<b>PC60-6</b> (EXCAVATORS) 4D95L-1AA		Fuel Filter.....	FC-5604	<b>PC650-1</b> (EXCAVATORS) S6D170	
Oil Filter Full Flow.....	C-5615	Hydraulic Oil Filter.....	H-5607	Air Filter Secondary.....	A-5408
Oil Filter Full Flow.....	C-5616	Oil Filter Full Flow.....	C-5604	Air Filter Primary.....	A-6113
<b>PC60-6</b> (EXCAVATORS) 4D95L-1BB		<b>PC60U-5</b> (EXCAVATORS) KOMATSU S4D95L-1K		Coolant Filter.....	WC-6901
Oil Filter Full Flow.....	C-5615	Air Filter Secondary.....	A-5647	Fuel Filter.....	FC-5606
Oil Filter Full Flow.....	C-5616	<b>PC60U-5</b> (EXCAVATORS) S/N: 4501		Fuel Filter.....	FC-5602
<b>PC60-7</b> (EXCAVATORS) 4D95L-1/45001/15067		Air Filter Primary.....	AS-1014	Hydraulic Oil Filter.....	H-85680
Air Filter.....	A-5677	Hydraulic Oil Filter.....	H-5607	Hydraulic Oil Filter.....	H-7911
Fuel Filter.....	FC-1801	Oil Filter Full Flow.....	C-5604	Hydraulic Oil Filter.....	HC-5601
Fuel Filter Secondary.....	FC-7903	<b>PC650</b> (EXCAVATORS) KT-1150		Oil Filter By Pass.....	O-5704
Fuel/Water Separator.....	SFC-5708	Coolant Filter.....	WC-5705	Oil Filter Full Flow.....	C-5605
Hydraulic Oil Filter.....	H-5607	Fuel Filter.....	FC-5602	Oil Filter Full Flow.....	C-5715
Oil Filter Full Flow.....	C-5606	Hydraulic Oil Filter.....	H-85680	Oil Filter Full Flow.....	C-5701
Oil Filter Full Flow.....	C-5703	Hydraulic Oil Filter.....	H-7911	<b>PC650-1A</b> (EXCAVATORS) S6D170-1	
<b>PC60-7</b> (EXCAVATORS) 4D95LE-2		Oil Filter Full Flow.....	C-5715	Air Filter Secondary.....	A-5408
Air Filter.....	A-5677	Oil Filter By Pass.....	O-5704	Air Filter Primary.....	A-6113
Hydraulic Oil Filter.....	H-5607	<b>PC650</b> (EXCAVATORS) S6D170		Coolant Filter.....	WC-6901
Oil Filter Full Flow.....	C-5616	Coolant Filter.....	WC-6901	Fuel Filter.....	FC-5602
Oil Filter Full Flow.....	C-5604	Fuel Filter.....	FC-5602	Hydraulic Oil Filter.....	H-85680
Oil Filter Full Flow.....	C-5615	Hydraulic Oil Filter.....	H-85680	Hydraulic Oil Filter.....	HC-5601
<b>PC60-7</b> (EXCAVATORS) KOMATSU 4D102E-1B-1		Hydraulic Oil Filter.....	H-7911	Hydraulic Oil Filter.....	H-7911
Air Filter Secondary.....	A-5647	Oil Filter Full Flow.....	C-5605	Oil Filter Full Flow.....	C-5715
<b>PC60D-2</b> (EXCAVATORS) 4D94-2		Oil Filter Full Flow.....	C-5701	Oil Filter Full Flow.....	C-5605
Fuel Filter.....	FC-5604	Oil Filter Full Flow.....	C-5715	Oil Filter Full Flow.....	C-5701
Hydraulic Oil Filter.....	H-5607	<b>PC650</b> (EXCAVATORS) SA6D140		<b>PC650-3</b> (EXCAVATORS) KT19C	
Oil Filter Full Flow.....	C-5606	Air Filter Primary.....	A-5614	Air Filter Secondary.....	A-5610
<b>PC60D-2</b> (EXCAVATORS) 4D94-3		Air Filter Secondary.....	A-5610	Air Filter Primary.....	A-5614
Fuel Filter.....	FC-5604	Fuel Filter.....	FC-5703	Coolant Filter.....	WC-6901
Hydraulic Oil Filter.....	H-5607	Fuel/Water Separator.....	SFC-5707	Fuel Filter.....	FC-5703
Oil Filter Full Flow.....	C-5606	Hydraulic Oil Filter.....	H-85680	Fuel/Water Separator.....	SFC-5707
<b>PC650-3</b> (EXCAVATORS) SA6D140-1/10501/10420		Hydraulic Oil Filter.....	H-7911	Hydraulic Oil Filter.....	H-7911
		Oil Filter Full Flow.....	C-5605	Hydraulic Oil Filter.....	HC-5601
		Oil Filter Full Flow.....	C-5701	Hydraulic Oil Filter.....	H-85680
				Oil Filter Full Flow.....	C-5715
				Oil Filter Full Flow.....	C-5701
				Oil Filter Full Flow.....	C-5605

MODEL/APPLICATION	SAKURA NO	MODEL/APPLICATION	SAKURA NO	MODEL/APPLICATION	SAKURA NO
<b>KOMATSU</b>		<b>KOMATSU</b>		<b>KOMATSU</b>	
<b>PC650-3</b> (EXCAVATORS) SA6D140-1/10501/10420		Coolant Filter.....	WC-6901	Hydraulic Oil Filter.....	H-7911
Air Filter Secondary.....	A-5610	Fuel Filter.....	FC-5703	Hydraulic Oil Filter.....	H-5652
Air Filter Primary.....	A-5614	Fuel/Water Separator.....	SFC-5707	Oil Filter Full Flow.....	C-5605
Fuel Filter.....	FC-5703	Hydraulic Oil Filter.....	H-7911	Oil Filter Full Flow.....	C-5701
Fuel/Water Separator.....	SFC-5707	Hydraulic Oil Filter.....	HC-5601	Oil Filter By Pass.....	C-5718
Hydraulic Oil Filter.....	H-85680	Hydraulic Oil Filter.....	H-85680	Oil Filter Full Flow.....	C-5715
Hydraulic Oil Filter.....	H-5652	Oil Filter Full Flow.....	C-5605	<b>PC600-6</b> (EXCAVATORS) SA6D140E	
Hydraulic Oil Filter.....	H-7911	Oil Filter Full Flow.....	C-5701	Fuel Filter.....	FC-5703
Hydraulic Oil Filter.....	HC-5601	Oil Filter Full Flow.....	C-5715	Fuel/Water Separator.....	SFC-5707
Oil Filter Full Flow.....	C-5605	<b>PC650LC-5</b> (EXCAVATORS) SA6D140-1/20001/18624		Oil Filter Full Flow.....	C-5605
Oil Filter Full Flow.....	C-5701	Air Filter Secondary.....	A-5610	Oil Filter Full Flow.....	C-5701
Oil Filter Full Flow.....	C-5715	Air Filter Primary.....	A-5614	Oil Filter Full Flow.....	C-5715
<b>PC650-5</b> (EXCAVATORS) SA6D140-1/20001/18624		Coolant Filter.....	WC-6901	<b>PC600LC-7</b> (EXCAVATORS) SA6D140E-3 , 2004	
Air Filter Secondary.....	A-5610	Fuel Filter.....	FC-5703	Air Filter Secondary.....	A-8580
Air Filter Primary.....	A-5614	Fuel/Water Separator.....	SFC-5707	Air Filter Primary.....	A-8665M
Coolant Filter.....	WC-6901	Hydraulic Oil Filter.....	H-7911	Cabin Air Filter.....	CA-5602
Fuel Filter.....	FC-5703	Hydraulic Oil Filter.....	H-85680	Cabin Air Filter.....	CA-56041
Fuel/Water Separator.....	SFC-5707	Hydraulic Oil Filter.....	H-5652	Fuel/Water Separator Secondary..	SFC-5611-10
Hydraulic Oil Filter.....	H-7911	Hydraulic Oil Filter.....	HC-5601	Fuel/Water Separator Secondary..	SFC-5611-10B
Hydraulic Oil Filter.....	HC-5601	Oil Filter By Pass.....	C-5718	Hydraulic Breather.....	H-56610
Hydraulic Oil Filter.....	H-85680	Oil Filter Full Flow.....	C-5715	<b>PC600LC-7MH</b> (EXCAVATORS) SA6D140E-3 , 2004	
Hydraulic Oil Filter.....	H-5652	Oil Filter Full Flow.....	C-5605	Air Filter Secondary.....	A-8580
Oil Filter Full Flow.....	C-5605	Oil Filter Full Flow.....	C-5701	Air Filter Primary.....	A-8665M
Oil Filter Full Flow.....	C-5715	Oil Filter By Pass.....	C-5718	Cabin Air Filter.....	CA-56041
Oil Filter By Pass.....	C-5718	Oil Filter Full Flow.....	C-5605	Cabin Air Filter.....	CA-5602
Oil Filter Full Flow.....	C-5701	Oil Filter Full Flow.....	C-5701	Fuel/Water Separator Secondary..	SFC-5611-10B
<b>PC650-5SER</b> (EXCAVATORS)		<b>PC650LC-5</b> (EXCAVATORS) SA6D140-1/20001/17739/18623		Fuel/Water Separator Secondary..	SFC-5611-10
Air Filter Primary.....	A-5614	Air Filter Secondary.....	A-5610	Fuel/Water Separator Secondary..	SFC-5611-10
Coolant Filter.....	WC-56010	Air Filter Primary.....	A-5614	Hydraulic Breather.....	H-56610
Fuel Filter.....	FC-5703	Fuel Filter.....	FC-5703	<b>PC60-8</b> (EXCAVATORS) SAA4D95LE-5	
Fuel/Water Separator.....	SFC-5707	Fuel/Water Separator.....	SFC-5707	Fuel/Water Separator.....	SFC-56060
Hydraulic Oil Filter.....	H-7911	Hydraulic Oil Filter.....	H-85680	<b>PC70</b> (EXCAVATORS) 4D95L	
Hydraulic Oil Filter.....	HC-5601	Hydraulic Oil Filter.....	H-5652	Air Filter.....	A-5677
Hydraulic Oil Filter.....	H-85680	Hydraulic Oil Filter.....	H-7911	Fuel Filter.....	FC-1801
Oil Filter Full Flow.....	C-5605	Oil Filter Full Flow.....	C-5605	Hydraulic Oil Filter.....	H-5607
Oil Filter Full Flow.....	C-5715	Oil Filter Full Flow.....	C-5701	<b>PC710</b> (EXCAVATORS) SA6D140	
Oil Filter Full Flow.....	C-5701	Oil Filter By Pass.....	C-5718	Air Filter Secondary.....	A-5610
Oil Filter By Pass.....	C-5718	Oil Filter Full Flow.....	C-5715	Air Filter Primary.....	A-5614
<b>PC650E-1</b> (EXCAVATORS) S6D170		Oil Filter Full Flow.....	C-5701	Fuel Filter.....	FC-5703
Air Filter Primary.....	A-6113	<b>PC650SE-5</b> (EXCAVATORS) SA6D140-1/20001/18624		Fuel/Water Separator.....	SFC-5707
Air Filter Secondary.....	A-5408	Air Filter Secondary.....	A-5610	Hydraulic Oil Filter.....	H-7911
Coolant Filter.....	WC-6901	Air Filter Primary.....	A-5614	Hydraulic Oil Filter.....	H-85680
Fuel Filter.....	FC-5606	Coolant Filter.....	WC-6901	Hydraulic Oil Filter.....	H-85680
Fuel Filter.....	FC-5602	Fuel Filter.....	FC-5703	Oil Filter Full Flow.....	C-5605
Hydraulic Oil Filter.....	H-7911	Fuel/Water Separator.....	SFC-5707	Oil Filter Full Flow.....	C-5715
Hydraulic Oil Filter.....	HC-5601	Hydraulic Oil Filter.....	H-5652	Oil Filter Full Flow.....	C-5701
Hydraulic Oil Filter.....	H-85680	Hydraulic Oil Filter.....	H-7911	<b>PC710-5</b> (EXCAVATORS) SA6D140-1/11019/18624	
Oil Filter By Pass.....	0-5704	Hydraulic Oil Filter.....	HC-5601	Air Filter Secondary.....	A-5610
Oil Filter Full Flow.....	C-5605	Hydraulic Oil Filter.....	H-85680	Air Filter Primary.....	A-5614
Oil Filter Full Flow.....	C-5715	Oil Filter Full Flow.....	C-5701	Fuel Filter.....	FC-5703
Oil Filter Full Flow.....	C-5701	Oil Filter By Pass.....	C-5718	Fuel/Water Separator.....	SFC-5707
<b>PC650LC-3</b> (EXCAVATORS) KT19C		Oil Filter Full Flow.....	C-5605	Hydraulic Oil Filter.....	H-85680
Air Filter Secondary.....	A-5610	Oil Filter Full Flow.....	C-5715	Hydraulic Oil Filter.....	H-7911
Air Filter Primary.....	A-5614	Oil Filter Full Flow.....	C-5701	<b>PC710-5</b> (EXCAVATORS) SA6D140-1/11019/18624	
<b>PC650LC-3</b> (EXCAVATORS) KT19C		Oil Filter Full Flow.....	C-5701	Air Filter Secondary.....	A-5610
Air Filter Secondary.....	A-5610	Air Filter Secondary.....	A-5610	Air Filter Primary.....	A-5614
Air Filter Primary.....	A-5614	Air Filter Primary.....	A-5614	Fuel Filter.....	FC-5703
<b>PC650LC-3</b> (EXCAVATORS) KT19C		Fuel Filter.....	FC-5703	Fuel/Water Separator.....	SFC-5707
Air Filter Secondary.....	A-5610	Fuel/Water Separator.....	SFC-5707	Hydraulic Oil Filter.....	H-85680
Air Filter Primary.....	A-5614	Hydraulic Oil Filter.....	H-85680	Hydraulic Oil Filter.....	H-7911

MODEL/APPLICATION	SAKURA NO	MODEL/APPLICATION	SAKURA NO	MODEL/APPLICATION	SAKURA NO
<b>KOMATSU</b>		<b>KOMATSU</b>		<b>KOMATSU</b>	
<b>PC710-5</b> <b>(EXCAVATORS)</b> <b>SA6D140-1/11019/18624</b>		Coolant Filter.....	WC-56010	Oil Filter Full Flow.....	C-5715
Hydraulic Oil Filter.....	H-5652	Fuel Filter.....	FC-5703	Oil Filter Full Flow.....	C-5605
Oil Filter Full Flow.....	C-5701	Fuel/Water Separator.....	SFC-5707	Oil Filter Full Flow.....	C-5505
Oil Filter By Pass.....	C-5718	Hydraulic Oil Filter.....	H-5652	<b>PC750LC-6</b> <b>(EXCAVATORS)</b> <b>SAAGD140E-2</b>	
Oil Filter Full Flow.....	C-5605	Hydraulic Oil Filter.....	H-7911	Air Filter Secondary.....	A-5610
Oil Filter Full Flow.....	C-5715	Hydraulic Oil Filter.....	H-85680	Air Filter Primary.....	A-5614
<b>PC710-5SER</b> <b>(EXCAVATORS)</b>		Oil Filter Full Flow.....	C-5701	Fuel Filter.....	FC-5703
Air Filter Primary.....	A-5614	Oil Filter By Pass.....	C-5718	Fuel/Water Separator.....	SFC-5707
Fuel Filter.....	FC-5703	Oil Filter Full Flow.....	C-5715	Hydraulic Oil Filter.....	H-7911
Fuel/Water Separator.....	SFC-5707	Oil Filter Full Flow.....	C-5505	Hydraulic Oil Filter.....	H-85680
Hydraulic Oil Filter.....	HC-5601	Oil Filter Full Flow.....	C-5605	Oil Filter Full Flow.....	C-5715
Hydraulic Oil Filter.....	H-85680	<b>PC750-6</b> <b>(EXCAVATORS)</b> <b>SAAGD140E</b>		Oil Filter Full Flow.....	C-5701
Oil Filter Full Flow.....	C-5605	Air Filter Secondary.....	A-5610	Oil Filter Full Flow.....	C-5605
Oil Filter Full Flow.....	C-5701	Air Filter Primary.....	A-5614	Oil Filter Full Flow.....	C-5505
Oil Filter By Pass.....	C-5718	Fuel Filter.....	FC-5703	Oil Filter Full Flow.....	C-5505
Oil Filter Full Flow.....	C-5715	Fuel/Water Separator.....	SFC-5707	<b>PC750LC-6MH</b> <b>(EXCAVATORS)</b> <b>SAAGD140E</b>	
<b>PC710SE-5</b> <b>(EXCAVATORS)</b> <b>SA6D140-1/11019/18624</b>		Hydraulic Oil Filter.....	H-7911	Air Filter Secondary.....	A-5610
Air Filter Primary.....	A-5614	Hydraulic Oil Filter.....	H-85680	Air Filter Primary.....	A-5614
Air Filter Secondary.....	A-5610	Oil Filter Full Flow.....	C-5701	Fuel Filter.....	FC-5703
Fuel Filter.....	FC-5703	Oil Filter Full Flow.....	C-5715	Fuel/Water Separator.....	SFC-5707
Fuel/Water Separator.....	SFC-5707	Oil Filter Full Flow.....	C-5505	Hydraulic Oil Filter.....	H-7911
Hydraulic Oil Filter.....	H-85680	Oil Filter Full Flow.....	C-5605	Hydraulic Oil Filter.....	H-85680
Hydraulic Oil Filter.....	H-5652	Oil Filter Full Flow.....	C-5701	Oil Filter Full Flow.....	C-5505
Hydraulic Oil Filter.....	H-7911	Oil Filter By Pass.....	C-5718	Oil Filter Full Flow.....	C-5605
Oil Filter Full Flow.....	C-5715	Oil Filter Full Flow.....	C-5715	Oil Filter Full Flow.....	C-5701
Oil Filter Full Flow.....	C-5605	<b>PC750-6</b> <b>(EXCAVATORS)</b> <b>SAAGD140E-2</b>		Oil Filter Full Flow.....	C-5715
Oil Filter Full Flow.....	C-5701	Air Filter Secondary.....	A-5610	<b>PC750LC-6MH</b> <b>(EXCAVATORS)</b> <b>SAAGD140E-2</b>	
Oil Filter Full Flow.....	C-5701	Air Filter Primary.....	A-5614	Air Filter Primary.....	A-5614
Oil Filter By Pass.....	C-5718	Fuel Filter.....	FC-5703	Air Filter Secondary.....	A-5610
<b>PC75</b> <b>(EXCAVATORS)</b> <b>4D95L</b>		Fuel/Water Separator.....	SFC-5707	Fuel Filter.....	FC-5703
Fuel Filter.....	FC-1801	Hydraulic Oil Filter.....	H-7911	Fuel/Water Separator.....	SFC-5707
Hydraulic Oil Filter.....	H-5607	Hydraulic Oil Filter.....	H-85680	Hydraulic Oil Filter.....	H-7911
Oil Filter Full Flow.....	C-5606	Oil Filter Full Flow.....	C-5701	Hydraulic Oil Filter.....	H-85680
<b>PC75</b> <b>(EXCAVATORS)</b>		Oil Filter Full Flow.....	C-5505	Oil Filter Full Flow.....	C-5505
Fuel Filter.....	FC-1016	Oil Filter Full Flow.....	C-5605	Oil Filter Full Flow.....	C-5605
Oil Filter Full Flow.....	C-1011	Oil Filter Full Flow.....	C-5715	Oil Filter Full Flow.....	C-5701
<b>PC750</b> <b>(EXCAVATORS)</b> <b>CUMMINS QSK19</b>		<b>PC750LC-6</b> <b>(EXCAVATORS)</b> <b>QSK19</b>		Oil Filter Full Flow.....	C-5715
Fuel/Water Separator.....	SFC-5709-10	Air Filter Secondary.....	A-5610	<b>PC750SE-6</b> <b>(EXCAVATORS)</b> <b>QSK19</b>	
<b>PC750</b> <b>(EXCAVATORS)</b> <b>QSK19</b>		Air Filter Primary.....	A-5614	Air Filter Secondary.....	A-5610
Fuel/Water Separator.....	SFC-5709-10	Coolant Filter.....	WC-56010	Air Filter Primary.....	A-5614
Oil Filter Combination.....	C-5723	Fuel Filter.....	FC-5703	Coolant Filter.....	WC-56010
<b>PC7500-1</b> <b>(EXCAVATORS)</b>		Fuel/Water Separator.....	SFC-5707	Fuel Filter.....	FC-5703
Air Filter.....	A-5677	Hydraulic Oil Filter.....	H-7911	Fuel/Water Separator.....	SFC-5707
Fuel Filter.....	FC-5604	Hydraulic Oil Filter.....	H-85680	Hydraulic Oil Filter.....	H-7911
Hydraulic Oil Filter.....	H-5607	Hydraulic Oil Filter.....	H-5652	Hydraulic Oil Filter.....	H-5652
Oil Filter Full Flow.....	C-5405	Oil Filter By Pass.....	C-5718	Hydraulic Oil Filter.....	H-85680
<b>PC750-6</b> <b>(EXCAVATORS)</b> <b>QSK19</b>		Oil Filter Full Flow.....	C-5715	Oil Filter Full Flow.....	C-5701
Fuel/Water Separator.....	SFC-5709-10	Oil Filter Full Flow.....	C-5701	Oil Filter Full Flow.....	C-5505
Oil Filter Full Flow.....	C-5723	Oil Filter Full Flow.....	C-5605	Oil Filter Full Flow.....	C-5605
<b>PC7500-1</b> <b>(EXCAVATORS)</b>		Oil Filter Full Flow.....	C-5505	Oil Filter Full Flow.....	C-5715
Air Filter.....	A-5677	<b>PC750LC-6</b> <b>(EXCAVATORS)</b> <b>SAAGD140E</b>		Oil Filter By Pass.....	C-5718
Fuel Filter.....	FC-5604	Air Filter Secondary.....	A-5610	<b>PC750SE-6</b> <b>(EXCAVATORS)</b> <b>SAAGD140E/10001</b>	
Hydraulic Oil Filter.....	H-5607	Air Filter Primary.....	A-5614	Air Filter Secondary.....	A-5610
Oil Filter Full Flow.....	C-5405	Fuel Filter.....	FC-5703	Air Filter Primary.....	A-5614
<b>PC750-6</b> <b>(EXCAVATORS)</b> <b>QSK19</b>		Fuel/Water Separator.....	SFC-5707	Fuel Filter.....	FC-5703
Air Filter Secondary.....	A-5610	Hydraulic Oil Filter.....	H-7911	<b>PC750SE-6</b> <b>(EXCAVATORS)</b> <b>SAAGD140E/10001</b>	
Air Filter Primary.....	A-5614	Hydraulic Oil Filter.....	H-85680	Air Filter Secondary.....	A-5610
Fuel Filter.....	FC-5703	Oil Filter Full Flow.....	C-5701	Air Filter Primary.....	A-5614
Fuel/Water Separator.....	SFC-5707	<b>PC750LC-6</b> <b>(EXCAVATORS)</b> <b>SAAGD140E</b>		Fuel Filter.....	FC-5703
Hydraulic Oil Filter.....	H-7911	Air Filter Secondary.....	A-5610		
Hydraulic Oil Filter.....	H-85680	Air Filter Primary.....	A-5614		
Oil Filter Full Flow.....	C-5701	Fuel Filter.....	FC-5703		
Oil Filter Full Flow.....	C-5701	Fuel/Water Separator.....	SFC-5707		
		Hydraulic Oil Filter.....	H-7911		
		Hydraulic Oil Filter.....	H-85680		
		Oil Filter Full Flow.....	C-5701		

MODEL/APPLICATION	SAKURA NO	MODEL/APPLICATION	SAKURA NO	MODEL/APPLICATION	SAKURA NO
<b>KOMATSU</b>		<b>KOMATSU</b>		<b>KOMATSU</b>	
<b>PC750SE-6</b> (EXCAVATORS) SAA6D140E/10001		<b>PC78MR-6</b> (EXCAVATORS) S4D95LE-3A		Oil Filter Full Flow.....	C-5614
Fuel/Water Separator.....	SFC-5707	Hydraulic Oil Filter.....	H-56540	<b>PC80</b> (EXCAVATORS) 4D95L	
Hydraulic Oil Filter.....	H-85680	<b>PC78MR-8</b> (EXCAVATORS)		Air Filter Primary.....	AS-1014
Hydraulic Oil Filter.....	H-7911	Fuel Filter.....	FC-1801	Fuel Filter.....	FC-5604
Oil Filter Full Flow.....	C-5715	Oil Filter Full Flow.....	C-56191	Hydraulic Oil Filter.....	H-5607
Oil Filter Full Flow.....	C-5701	Oil Filter Full Flow.....	C-56190	Oil Filter Full Flow.....	C-5405
Oil Filter Full Flow.....	C-5505	<b>PC750LC-7</b> (EXCAVATORS) SAA6D140E		<b>PC80</b> (EXCAVATORS) w/Komatsu 4D105 Eng	
Oil Filter Full Flow.....	C-5605	Air Filter Primary.....	A-8665M	Hydraulic Oil Filter.....	H-5519
<b>PC750SE-6</b> (EXCAVATORS) SAA6D140E-2/10001		Air Filter Secondary.....	A-8580	<b>PC800</b> (EXCAVATORS) 2006	
Air Filter Secondary.....	A-5610	Cabin Air Filter.....	CA-56041	Air Filter Secondary.....	A-8580
Air Filter Primary.....	A-5614	Coolant Filter.....	WC-56010	Air Filter Primary.....	A-8665M
Fuel Filter.....	FC-5703	Hydraulic Oil Filter.....	H-5618	Fuel/Water Separator Secondary..	SFC-5611-10B
Fuel/Water Separator.....	SFC-5707	Hydraulic Oil Filter.....	HC-5602	Fuel/Water Separator Secondary..	SFC-5611-10
Hydraulic Oil Filter.....	H-85680	Hydraulic Oil Filter.....	H-56610	Hydraulic Oil Filter.....	HC-5602
Hydraulic Oil Filter.....	H-7911	Hydraulic Breather.....	H-56610	Hydraulic Breather.....	H-56610
Oil Filter Full Flow.....	C-5701	<b>PC750LC-7MH</b> (EXCAVATORS) SAA6D140E		<b>PC800-7</b> (EXCAVATORS) 2006	
Oil Filter Full Flow.....	C-5505	Air Filter Primary.....	A-8665M	Air Filter Secondary.....	A-8580
Oil Filter Full Flow.....	C-5605	Air Filter Secondary.....	A-8580	Air Filter Primary.....	A-8665M
Oil Filter Full Flow.....	C-5715	Cabin Air Filter.....	CA-56041	Fuel/Water Separator Secondary..	SFC-5611-10
<b>PC75R</b> (EXCAVATORS)		Coolant Filter.....	WC-56010	Fuel/Water Separator Secondary..	SFC-5611-10B
Air Filter Secondary.....	A-7964	Hydraulic Oil Filter.....	H-5618	Hydraulic Oil Filter.....	HC-5602
Air Filter Secondary.....	A-7004	Hydraulic Oil Filter.....	HC-5602	Hydraulic Breather.....	H-56610
Fuel Filter.....	F-5218	Hydraulic Breather.....	H-56610	<b>PC800SE-6</b> (EXCAVATORS) SAA6D140E	
Fuel Filter.....	FC-1016	<b>PC78US-6</b> (EXCAVATORS) 4D95LE-2C		Air Filter Secondary.....	A-5610
Oil Filter Full Flow.....	C-1011	Hydraulic Oil Filter.....	H-56540	Air Filter Primary.....	A-5614
<b>PC75R-2</b> (EXCAVATORS) S/N: 22E5200001		<b>PC78US-6</b> (EXCAVATORS) S4D95LE-3		Fuel Filter.....	FC-5703
Fuel Filter.....	F-5218	Air Filter Primary.....	A-8505	Fuel/Water Separator.....	SFC-5707
Fuel Filter.....	FC-1016	Air Filter Secondary.....	A-8599	Hydraulic Oil Filter.....	H-85680
Oil Filter Full Flow.....	C-1011	Fuel Filter.....	FC-1108	Hydraulic Oil Filter.....	H-7911
<b>PC75UU-2</b> (EXCAVATORS) 4D95L-1		Fuel Filter.....	FC-1801	Oil Filter Full Flow.....	C-5701
Fuel Filter.....	FC-1801	Hydraulic Oil Filter.....	H-56540	Oil Filter Full Flow.....	C-5715
Fuel Filter Secondary.....	FC-7903	Oil Filter Full Flow.....	C-56190	Oil Filter Full Flow.....	C-5605
Fuel/Water Separator.....	SFC-5708	Oil Filter Full Flow.....	C-56191	<b>PC800SE-6</b> (EXCAVATORS) SAA6D140E-2/30001	
Hydraulic Oil Filter.....	H-5607	<b>PC78US-8</b> (EXCAVATORS) SAA4D95LE		Air Filter Secondary.....	A-5610
Oil Filter Full Flow.....	C-5606	Hydraulic Oil Filter.....	H-56540	Air Filter Primary.....	A-5614
<b>PC75UU-3</b> (EXCAVATORS) 4D102E-1C/15001		<b>PC78UU-6</b> (EXCAVATORS) 4D95LE-2C		Fuel Filter.....	FC-5703
Air Filter.....	A-5677	Hydraulic Oil Filter.....	H-56540	Fuel/Water Separator.....	SFC-5707
Fuel Filter Secondary.....	FC-7903	<b>PC78UU-6</b> (EXCAVATORS) S4D95LE-3		Hydraulic Oil Filter.....	H-7911
Fuel/Water Separator.....	SFC-5708	Hydraulic Oil Filter.....	H-56540	Hydraulic Oil Filter.....	H-85680
Oil Filter Full Flow.....	C-5703	<b>PC78UU-8</b> (EXCAVATORS) SAA4D95LE		Oil Filter Full Flow.....	C-5715
<b>PC75UU-3</b> (EXCAVATORS) KOMATSU 4D102E-1C		Hydraulic Oil Filter.....	H-56540	Oil Filter Full Flow.....	C-5605
Oil Filter Full Flow.....	C-5712	<b>PC80</b> (EXCAVATORS) 4D105		Oil Filter Full Flow.....	C-5505
<b>PC78MR-6</b> (EXCAVATORS) S4D95LE-3		Air Filter Secondary.....	A-7806	Oil Filter Full Flow.....	C-5701
Air Filter Primary.....	A-8505	Air Filter Primary.....	AS-7805	<b>PC800SE-6</b> (EXCAVATORS) SAA6D140E/30001	
Air Filter Secondary.....	A-8599	Fuel Filter.....	FC-5604	Air Filter Secondary.....	A-5610
Fuel Filter.....	FC-1108	Hydraulic Oil Filter.....	H-5622	Air Filter Primary.....	A-5614
Fuel Filter.....	FC-1801	<b>PC800SE-6</b> (EXCAVATORS) SAA6D140E/30001		Fuel Filter.....	FC-5703
Oil Filter Full Flow.....	C-56191	Air Filter Secondary.....	A-7806	Fuel/Water Separator.....	SFC-5707
Oil Filter Full Flow.....	C-56190	Air Filter Primary.....	AS-7805	Hydraulic Oil Filter.....	H-85680
<b>PC78MR-6</b> (EXCAVATORS) S4D95LE-3		Fuel Filter.....	FC-5604	Hydraulic Oil Filter.....	H-7911
Air Filter Primary.....	A-8505	Hydraulic Oil Filter.....	H-5622	Oil Filter Full Flow.....	C-5505
Air Filter Secondary.....	A-8599				
Fuel Filter.....	FC-1108				
Fuel Filter.....	FC-1801				
Oil Filter Full Flow.....	C-56191				
Oil Filter Full Flow.....	C-56190				

MODEL/APPLICATION	SAKURA NO	MODEL/APPLICATION	SAKURA NO	MODEL/APPLICATION	SAKURA NO
<b>KOMATSU</b>		<b>KOMATSU</b>		<b>KOMATSU</b>	
<b>PC800SE-6</b> (EXCAVATORS) SAA6D140E/30001		Cabin Air Filter.....	CA-56041	<b>PC90-1</b> (EXCAVATORS) 4D95L-1/1001/49969	
Oil Filter Full Flow.....	C-5715	Coolant Filter.....	WC-56010	Air Filter.....	A-5677
Oil Filter Full Flow.....	C-5701	Fuel/Water Separator Secondary..	SFC-5611-10	Fuel Filter.....	FC-1801
Oil Filter Full Flow.....	C-5605	Fuel/Water Separator Secondary..	SFC-5611-10B	Hydraulic Oil Filter.....	H-5607
		Hydraulic Oil Filter.....	HC-5602	Oil Filter Full Flow.....	C-5405
		Hydraulic Breather.....	H-56610		
<b>PC80-1</b> (EXCAVATORS) 4D105-5/1001/100006		<b>PC800-8K</b> (EXCAVATORS) SAA6D140E-5		<b>PC95</b> (EXCAVATORS)	
Air Filter Primary.....	AS-7805	Air Filter Secondary.....	A-8580	Air Filter Primary.....	AS-5628
Air Filter Secondary.....	A-7806	Air Filter Primary.....	A-8665M	Air Filter Primary.....	A-5628
Fuel Filter.....	FC-5604	Cabin Air Filter.....	CA-56041	Air Filter Set.....	A-5628-S
Hydraulic Oil Filter.....	H-5622	Coolant Filter.....	WC-56010	Fuel Filter.....	FC-5715
Oil Filter Full Flow.....	C-5614	Fuel/Water Separator Secondary..	SFC-5611-10		
		Fuel/Water Separator Secondary..	SFC-5611-10B	<b>PC95-1</b> (EXCAVATORS)	
<b>PC80-1</b> (EXCAVATORS) w/Komatsu 4D105-5K Eng		Hydraulic Oil Filter.....	HC-5602	Air Filter Primary.....	AS-5628
Hydraulic Oil Filter.....	H-5519	Hydraulic Breather.....	H-56610	Air Filter Primary.....	A-5628
				Air Filter Set.....	A-5628-S
<b>PC80-3</b> (EXCAVATORS) 4D95L-1/2001/15941		<b>PC800LC-8EO</b> (EXCAVATORS) SAA6D140E-5		<b>PC95R-2</b> (EXCAVATORS) 4D106	
Air Filter Primary.....	AS-1014	Air Filter Primary.....	A-8665M	Air Filter Primary.....	A-5541
Fuel Filter.....	FC-5604	Air Filter Secondary.....	A-8580	Air Filter Secondary.....	A-5540
Hydraulic Oil Filter.....	H-5607	Cabin Air Filter.....	CA-56041	Fuel Filter.....	FC-1016
Oil Filter Full Flow.....	C-5604	Coolant Filter.....	WC-56010	Oil Filter Full Flow.....	C-5204
		Fuel/Water Separator Secondary..	SFC-5611-10B		
<b>PC80-3-SER</b> (EXCAVATORS)		Fuel/Water Separator Secondary..	SFC-5611-10	<b>PC95R-2</b> (EXCAVATORS)	
Air Filter Primary.....	AS-1014	Hydraulic Oil Filter.....	HC-5602	Fuel/Water Separator.....	SF-52150
Fuel Filter.....	FC-5604	Hydraulic Breather.....	H-56610		
Hydraulic Oil Filter.....	H-5607			<b>PD-105</b> (MOTOR GRADERS) 16V-71	
Oil Filter Full Flow.....	C-5604	<b>PC800LC-8K</b> (EXCAVATORS) SAA6D140E-5		Fuel Filter.....	FC-1810
		Air Filter Secondary.....	A-8580	Fuel/Water Separator.....	SFC-5705
<b>PC80LC-3</b> (EXCAVATORS) 4D95L-1/2001/15941		Air Filter Primary.....	A-8665M		
Air Filter Primary.....	AS-1014	Cabin Air Filter.....	CA-56041	<b>PF55L-1</b> (EXCAVATORS) S6D105-B-1A/10001/81935	
Fuel Filter.....	FC-5604	Coolant Filter.....	WC-56010	Coolant Filter.....	WC-5707
Hydraulic Oil Filter.....	H-5607	Fuel/Water Separator Secondary..	SFC-5611-10	Fuel Filter.....	FC-5621
Oil Filter Full Flow.....	C-5604	Fuel/Water Separator Secondary..	SFC-5611-10B	Hydraulic Oil Filter.....	H-5609
		Hydraulic Oil Filter.....	HC-5602	Oil Filter Full Flow.....	C-5608
<b>PC800-8</b> (EXCAVATORS) SAA6D140E-5		Hydraulic Breather.....	H-56610		
Air Filter Secondary.....	A-8580	<b>PC88MR-8</b> (EXCAVATORS) SAA4D95LE-5 , 2008		<b>PF-666</b> (MOTOR GRADERS) CUMMINS	
Air Filter Primary.....	A-8665M	Cabin Air Filter.....	CA-56041	Fuel Filter.....	FC-5720
Cabin Air Filter.....	CA-56041	Oil Filter Full Flow.....	C-56190	Fuel Filter.....	F-5701
Coolant Filter.....	WC-56010	Oil Filter Full Flow.....	C-56191	Fuel Filter.....	FC-1303
Fuel/Water Separator Secondary..	SFC-5611-10	<b>PC88MR-8</b> (EXCAVATORS) KOMATSU SAA4D95LE-5		Fuel/Water Separator.....	SFC-5705
Fuel/Water Separator Secondary..	SFC-5611-10B	Fuel Filter.....	FC-56290	Hydraulic Oil Filter Transmission...	H-65030
Hydraulic Oil Filter.....	HC-5602			Oil Filter Full Flow.....	O-6503
Hydraulic Breather.....	H-56610	<b>PC88MR-8</b> (EXCAVATORS) SAA4D95LE-5		Oil Filter Full Flow.....	C-8031
		Hydraulic Oil Filter.....	H-56540	Oil Filter Full Flow.....	O-5702
<b>PC800-8EO</b> (EXCAVATORS) SAA6D140E-5		<b>PC88MR-8</b> (EXCAVATORS) S/N: F80003-UP		<b>PF-666</b> (MOTOR GRADERS) DETROIT DIESEL	
Air Filter Secondary.....	A-8580	Hydraulic Breather.....	H-42300	Fuel Filter.....	F-6503
Air Filter Primary.....	A-8665M	<b>PC90</b> (EXCAVATORS) 4D95L		Fuel Filter Secondary.....	F-6502
Cabin Air Filter.....	CA-56041	Air Filter.....	A-5677	Fuel Filter.....	F-6505
Coolant Filter.....	WC-56010	Fuel Filter.....	FC-1801	Oil Filter Full Flow.....	O-6503
Fuel/Water Separator Secondary..	SFC-5611-10B	Hydraulic Oil Filter.....	H-5607		
Fuel/Water Separator Secondary..	SFC-5611-10	Oil Filter Full Flow.....	C-5405	<b>PF-777</b> (MOTOR GRADERS) CUMMINS	
Hydraulic Oil Filter.....	HC-5602			Fuel Filter.....	FC-5720
Hydraulic Breather.....	H-56610			Fuel Filter.....	F-5701
				Fuel Filter.....	FC-1303
<b>PC800LC-8</b> (EXCAVATORS) SAA6D140E-5					
Air Filter Secondary.....	A-8580				
Air Filter Primary.....	A-8665M				

MODEL/APPLICATION	SAKURA NO	MODEL/APPLICATION	SAKURA NO	MODEL/APPLICATION	SAKURA NO
<b>KOMATSU</b>		<b>KOMATSU</b>		<b>KOMATSU</b>	
<b>PF-777</b> (MOTOR GRADERS) CUMMINS Fuel/Water Separator..... SFC-5705 Hydraulic Oil Filter Transmission... H-65030 Oil Filter Full Flow..... C-8031 Oil Filter Full Flow..... O-6503 Oil Filter Full Flow..... O-5702		<b>PW110R</b> (EXCAVATORS) KOMATSU S4D106-1FB Fuel/Water Separator..... SF-52150 <b>PW110R</b> (EXCAVATORS) Air Filter Secondary..... A-5540 Fuel Filter..... FC-1016 Oil Filter Full Flow..... C-5204		<b>PW170ES-6</b> (EXCAVATORS) Air Filter Secondary..... A-7964 Air Filter Primary..... AS-7988 Fuel Filter Secondary..... FC-7903 Fuel/Water Separator..... SFC-5706 Fuel/Water Separator..... SFC-5708 Hydraulic Oil Filter..... H-56600 Hydraulic Oil Filter..... H-5610	
<b>PF-777</b> (MOTOR GRADERS) DETROIT DIESEL Fuel Filter..... F-6503 Fuel Filter..... F-6505 Fuel Filter Secondary..... F-6502 Oil Filter Full Flow..... O-6503		<b>PW130</b> (EXCAVATORS) S4D961-1 Air Filter Secondary..... A-7964 Air Filter Primary..... AS-7988 Fuel Filter..... FC-5605 Hydraulic Oil Filter..... H-5610 Hydraulic Oil Filter..... H-56600 Oil Filter Full Flow..... C-5606		<b>PW170ES-6</b> (EXCAVATORS) SA4D102E Air Filter Secondary..... A-7964 Air Filter Primary..... AS-7988 Cabin Air Filter Set..... CA-5601-S Cabin Air Filter..... CA-56041 Fuel/Water Separator..... SFC-5708 Hydraulic Oil Filter..... H-5610 Hydraulic Oil Filter..... H-56600	
<b>PW05-1</b> (EXCAVATORS) 3D72-2/1001 Fuel Filter..... F-5207		<b>PW130ES-6</b> (EXCAVATORS) Air Filter Secondary..... A-7964 Air Filter Primary..... AS-7988 Fuel Filter Secondary..... FC-7903 Fuel/Water Separator..... SFC-5708 Hydraulic Oil Filter..... H-5610 Hydraulic Oil Filter..... H-56600		<b>PW170-SK</b> (EXCAVATORS) Air Filter Secondary..... A-7964 Air Filter Primary..... AS-7988 Fuel Filter..... FC-5715 Hydraulic Oil Filter..... H-56600 Hydraulic Oil Filter..... H-5610 Oil Filter Full Flow..... C-5102	
<b>PW100</b> (EXCAVATORS) S4D105-5 Air Filter Primary..... AS-1024 Air Filter Set..... AS-1024-S Air Filter Secondary..... A-6009 Fuel Filter..... FC-5604 Hydraulic Oil Filter..... H-56600 Hydraulic Oil Filter..... H-5610 Oil Filter Full Flow..... C-5614		<b>PW130ES-6K</b> (EXCAVATORS) S4D102E-1AA/K30545-UP/21273646-UP Air Filter Secondary..... A-7964 Air Filter Primary..... AS-7988 Fuel Filter Secondary..... FC-7903 Fuel/Water Separator..... SFC-5708 Hydraulic Oil Filter..... H-5610 Hydraulic Oil Filter..... H-56600 Hydraulic Oil Filter Suction..... H-2706		<b>PW170-SK</b> (EXCAVATORS) 1006-6TD Air Filter Secondary..... A-7964 Air Filter Primary..... AS-7988 Fuel Filter..... FC-5715 Hydraulic Oil Filter..... H-56600 Hydraulic Oil Filter..... H-5610 Oil Filter Full Flow..... C-5102	
<b>PW100-1</b> (EXCAVATORS) S4D105-5 Air Filter Primary..... AS-1024 Air Filter Secondary..... A-6009 Air Filter Set..... AS-1024-S Fuel Filter..... FC-5604 Hydraulic Oil Filter..... H-5610 Hydraulic Oil Filter..... H-56600 Oil Filter Full Flow..... C-5614		<b>PW150-1</b> (EXCAVATORS) 6D95L-1/1001 Air Filter Primary..... AS-7805 Air Filter Secondary..... A-7806 Fuel Filter..... FC-5604 Hydraulic Oil Filter..... H-56600 Hydraulic Oil Filter..... H-5610 Oil Filter Full Flow..... C-5604		<b>PW170-SK</b> (EXCAVATORS) 1006-6TLR2 Air Filter Secondary..... A-7964 Air Filter Primary..... AS-7988 Fuel Filter..... FC-5715 Hydraulic Oil Filter..... H-56600 Hydraulic Oil Filter..... H-5610 Oil Filter Full Flow..... C-5102	
<b>PW100-1</b> (EXCAVATORS) S4D105-5/1003 Fuel Filter..... FC-5604 Hydraulic Oil Filter..... H-5610 Hydraulic Oil Filter..... H-56600 Oil Filter Full Flow..... C-5614		<b>PW150ES-6</b> (EXCAVATORS) Air Filter Secondary..... A-7964 Air Filter Primary..... AS-7988 Fuel Filter Secondary..... FC-7903 Fuel/Water Separator..... SFC-5708 Hydraulic Oil Filter..... H-5610 Hydraulic Oil Filter..... H-56600		<b>PW170ES-6K</b> (EXCAVATORS) SA4D102E Air Filter Secondary..... A-7964 Air Filter Primary..... AS-7988 Cabin Air Filter Set..... CA-5601-S Cabin Air Filter..... CA-56041 Fuel/Water Separator..... SFC-5708 Hydraulic Oil Filter..... H-5610 Hydraulic Oil Filter..... H-56600	
<b>PW100-3</b> (EXCAVATORS) S6D95L-1/1601 Air Filter Primary..... AS-7805 Air Filter Secondary..... A-7806 Fuel Filter..... FC-5604 Hydraulic Oil Filter..... H-5610 Hydraulic Oil Filter..... H-56600 Oil Filter Full Flow..... C-5604		<b>PW160ES-7</b> (EXCAVATORS) Cabin Air Filter..... CA-56041 Fuel Filter Secondary..... FC-7903 Fuel/Water Separator..... SFC-5708 Hydraulic Oil Filter..... H-5629 Hydraulic Oil Filter..... H-5646		<b>PW170ES-6K</b> (EXCAVATORS) SA4D102E Air Filter Secondary..... A-7964 Air Filter Primary..... AS-7988 Cabin Air Filter Set..... CA-5601-S Cabin Air Filter..... CA-56041 Fuel/Water Separator..... SFC-5708 Hydraulic Oil Filter..... H-5610 Hydraulic Oil Filter..... H-56600	
<b>PW100-3SER</b> (EXCAVATORS) Air Filter Primary..... AS-7805 Air Filter Secondary..... A-7806 Fuel Filter..... FC-5604 Hydraulic Oil Filter..... H-56600 Hydraulic Oil Filter..... H-5610 Oil Filter Full Flow..... C-5604		<b>PW110R-1</b> (EXCAVATORS) KOMATSU Air Filter Secondary..... A-5540 Air Filter Primary..... A-5541 Fuel Filter..... FC-1016			

# Sakura Filter

# ENGINE APPLICATION

MODEL/APPLICATION	SAKURA NO	MODEL/APPLICATION	SAKURA NO	MODEL/APPLICATION	SAKURA NO
<b>KOMATSU</b>		<b>KOMATSU</b>		<b>KOMATSU</b>	
<b>PW110R-1</b> (EXCAVATORS) KOMATSU S4D106E-1FB		<b>PW160-7</b> (EXCAVATORS) SAA4D102E-2		Hydraulic Oil Filter.....	H-5629
Fuel/Water Separator.....	SF-52150	Air Filter Secondary.....	A-8670	<b>PW200-7H</b> (EXCAVATORS) H50051 - UP	
<b>PW118MR-8</b> (EXCAVATORS) SAA4D95LE-5 , 2011		Air Filter Secondary.....	A-5674	Air Filter Secondary.....	A-8578
Air Filter Primary.....	A-5541	Air Filter Primary.....	A-5673	Air Filter Primary.....	A-8577
Air Filter Secondary.....	A-5540	Air Filter Set.....	A-5675-S	Cabin Air Filter.....	CA-56041
Cabin Air Filter.....	CA-56041	Cabin Air Filter.....	CA-56041	Fuel Filter.....	F-5218
Fuel/Water Separator.....	SFC-56040	Fuel Filter.....	F-5218	Hydraulic Oil Filter.....	H-5629
Hydraulic Oil Filter.....	H-56650	Hydraulic Oil Filter.....	H-5646	Hydraulic Oil Filter.....	H-5646
Hydraulic Breather.....	H-56610	Hydraulic Oil Filter.....	H-5629	Hydraulic Breather.....	H-56610
Oil Filter Full Flow.....	C-56191	Hydraulic Breather.....	H-56610	Oil Filter Full Flow.....	C-5611
Oil Filter Full Flow.....	C-56190	Oil Filter Full Flow.....	C-5703	<b>PW220-7K</b> (EXCAVATORS) SAA6D102E-2	
<b>PW130-7K</b> (EXCAVATORS) SAA4D102E-2		<b>PW180-7</b> (EXCAVATORS) KOMATSU		Air Filter Primary.....	A-8577
Cabin Air Filter.....	CA-56041	Hydraulic Oil Filter.....	H-5629	Air Filter Secondary.....	A-8578
Fuel Filter Secondary.....	FC-7903	Hydraulic Oil Filter.....	H-5646	Cabin Air Filter.....	CA-5602
Fuel/Water Separator.....	SFC-5708	<b>PW160-7K</b> (EXCAVATORS) SAA4D102E-2		Cabin Air Filter.....	CA-56041
Hydraulic Oil Filter.....	H-56600	Air Filter Secondary.....	A-5674	Fuel Filter.....	F-5218
<b>PW140-7</b> (EXCAVATORS) SAA4D107E-1		<b>PW200</b> (EXCAVATORS) 2004		Hydraulic Oil Filter.....	H-5629
Air Filter Primary.....	A-8577	Air Filter Primary.....	A-8577	Hydraulic Oil Filter.....	H-5646
Air Filter Secondary.....	A-8578	Cabin Air Filter.....	CA-56041	Hydraulic Breather.....	H-56610
Cabin Air Filter.....	CA-56041	Fuel Filter Secondary.....	FC-7903	Oil Filter Full Flow.....	C-5611
Fuel Filter.....	FC-5613	Fuel/Water Separator.....	SFC-5708	<b>PW30-1</b> (EXCAVATORS) 3D84-1/1001	
Hydraulic Oil Filter.....	H-5629	Hydraulic Oil Filter.....	H-5646	Air Filter Primary.....	AS-2205
Hydraulic Oil Filter.....	H-5646	Hydraulic Oil Filter.....	H-5629	Fuel Filter.....	F-5207
Hydraulic Breather.....	H-56610	<b>PW200-7</b> (EXCAVATORS) SAA6D102E-2		Hydraulic Oil Filter.....	HC-5602
<b>PW148-8</b> (EXCAVATORS) SAA4D107E-1 , 2010		Air Filter Primary.....	A-8577	Oil Filter Full Flow.....	C-1920
Air Filter Secondary.....	A-8578	Air Filter Secondary.....	A-8578	<b>PW400MH-6</b> (EXCAVATORS) 6D125E-5	
Air Filter Primary.....	A-8577	Cabin Air Filter.....	CA-56041	Cabin Air Filter.....	CA-56070
Cabin Air Filter.....	CA-56041	Cabin Air Filter.....	CA-5602	Fuel Filter.....	FC-5606
Hydraulic Oil Filter.....	H-5629	Fuel Filter.....	F-5218	<b>PW60</b> (EXCAVATORS) 4D94-2	
Hydraulic Oil Filter.....	H-5646	Hydraulic Oil Filter.....	H-5629	Fuel Filter.....	FC-5604
Hydraulic Breather.....	H-56610	Hydraulic Oil Filter.....	H-5646	Hydraulic Oil Filter.....	H-5607
Oil Filter Full Flow.....	C-5611	Oil Filter Full Flow.....	C-5611	Oil Filter Full Flow.....	C-5606
<b>PW148-8</b> (EXCAVATORS) KOMATSU SAA4D107E-1		Oil Filter Full Flow.....	C-5610	<b>PW60-1</b> (EXCAVATORS) 1501	
Fuel/Water Separator.....	SFC-19100	<b>PW20-1</b> (EXCAVATORS) 3D84-1/1001		Air Filter Primary.....	AS-1014
<b>PW148-8</b> (EXCAVATORS) SAA4D107E-1		Air Filter Primary.....	AS-2205	Fuel Filter.....	FC-5604
Fuel Filter.....	FC-5613	Fuel Filter.....	F-5207	Hydraulic Oil Filter.....	H-5607
<b>PW150ES-6K</b> (EXCAVATORS) SAA4D102E-2		Hydraulic Oil Filter.....	HC-5602	Oil Filter Full Flow.....	C-5606
Air Filter Secondary.....	A-7964	Oil Filter Full Flow.....	C-1920	<b>PW60-1</b> (EXCAVATORS) 4D94-2D	
Air Filter Primary.....	AS-7988	<b>PW210-1</b> (EXCAVATORS) S6D105-1/10001		Air Filter Primary.....	AS-1014
Cabin Air Filter Set.....	CA-5601-S	Air Filter Secondary.....	A-5635	Fuel Filter.....	FC-5604
Fuel/Water Separator.....	SFC-5708	Air Filter Primary.....	A-5639	Hydraulic Oil Filter.....	H-5607
Hydraulic Oil Filter.....	H-56600	Hydraulic Oil Filter.....	H-5609	Oil Filter Full Flow.....	C-5606
Hydraulic Breather.....	H-56610	Oil Filter Full Flow.....	C-5608	<b>PW60-1</b> (EXCAVATORS) 4D94-2/1501	
Oil Filter Full Flow.....	C-5703	<b>PW220</b> (EXCAVATORS) 2004		Air Filter Primary.....	AS-1014
<b>PW160-7</b> (EXCAVATORS) KOMATSU SAA4D102E-2		Air Filter Primary.....	A-8577	Fuel Filter.....	FC-5604
Air Filter Secondary.....	A-56741	Cabin Air Filter.....	CA-56041	Hydraulic Oil Filter.....	H-5607
Air Filter Primary.....	A-56731	Fuel Filter Secondary.....	FC-7903	Oil Filter Full Flow.....	C-5606
Air Filter Set.....	A-56731-S	Fuel/Water Separator.....	SFC-5708	<b>PW60-1-SER</b> (EXCAVATORS)	
		Hydraulic Oil Filter.....	H-5646		

MODEL/APPLICATION	SAKURA NO	MODEL/APPLICATION	SAKURA NO	MODEL/APPLICATION	SAKURA NO
<b>KOMATSU</b>		<b>KOMATSU</b>		<b>KOMATSU</b>	
<b>PW60-1-SER</b> (EXCAVATORS)		<b>PW98MR-6</b> (EXCAVATORS) S4D95LE-3 , 2006		Fuel/Water Separator.....	SFC-5705
Air Filter Primary.....	AS-1014	Air Filter Secondary.....	A-7004	<b>S-9A</b> (SKIDDERS) D310	
Fuel Filter.....	FC-5604	Air Filter Primary.....	A-8624	Air Filter Primary.....	AS-5628
Hydraulic Oil Filter.....	H-5607	Fuel Filter.....	FC-5615	Air Filter Primary.....	A-5628
Oil Filter Full Flow.....	C-5606	Fuel Filter.....	FC-1108	Air Filter Set.....	A-5628-S
		Fuel Filter.....	FC-1801	<b>S9B</b> (SKIDDERS) DT360	
<b>PW60-3</b> (EXCAVATORS) 4D95L-1/2001		Oil Filter Full Flow.....	C-56191	Air Filter Primary.....	AS-1024
Air Filter Primary.....	AS-1014	Oil Filter Full Flow.....	C-56190	Air Filter Set.....	AS-1024-S
Fuel Filter.....	FC-5604	<b>PX21</b> (EXCAVATORS)		Air Filter Secondary.....	A-7809
Hydraulic Oil Filter.....	H-5607	Air Filter Secondary.....	A-8670	Fuel Filter.....	FC-7933
Oil Filter Full Flow.....	C-5604	Air Filter Secondary.....	A-5674	Fuel/Water Separator.....	SFC-5705
		Air Filter Primary.....	A-5673	<b>SD15</b> (FORKLIFTS) F2L411W	
<b>PW60N-1</b> (EXCAVATORS) 4D94-2D		Air Filter Set.....	A-5675-S	Fuel Filter.....	FC-6205
Air Filter Primary.....	AS-1014	Fuel Filter Secondary.....	FC-7903	Oil Filter Full Flow.....	C-8016
Fuel Filter.....	FC-5604	Fuel/Water Separator.....	SFC-5708	Oil Filter Full Flow.....	C-1828
Hydraulic Oil Filter.....	H-5607	<b>R2 D1394</b> (MOTOR GRADERS) S/N: 30601		<b>SD20</b> (FORKLIFTS) C221	
Oil Filter Full Flow.....	C-5606	Air Filter Secondary.....	A-5606	Oil Filter Full Flow.....	O-1803
		Air Filter Primary.....	A-5605	<b>SD25</b> (FORKLIFTS) F2L912	
<b>PW75</b> (EXCAVATORS)		Air Filter Set.....	A-5604-S	Air Filter.....	A-6809
Fuel Filter.....	FC-1016	Hydraulic Oil Filter.....	H-5620	Fuel Filter.....	FC-6205
Oil Filter Full Flow.....	C-1011	Oil Filter Full Flow.....	C-5614	Fuel Filter.....	F-2604
		<b>S-7B</b> (SKIDDERS) DETROIT DIESEL		<b>SD25F</b> (FORKLIFTS) F2L912	
<b>PW95</b> (EXCAVATORS)		Fuel Filter.....	F-6505	Air Filter.....	A-6809
Air Filter Primary.....	A-5628	Fuel Filter.....	F-6503	Fuel Filter.....	FC-6205
Air Filter Set.....	A-5628-S	Oil Filter Full Flow.....	O-6503	Fuel Filter.....	F-2604
Air Filter Primary.....	AS-5628	<b>S7C</b> (SKIDDERS) 3-53		Oil Filter Full Flow.....	C-6204
Fuel Filter.....	FC-5715	Fuel Filter Secondary.....	F-6502	<b>SK04</b> (LOADERS)	
		<b>S-7 SERIES B</b> (SKIDDERS) 220		Air Filter Primary.....	AS-2205
<b>PW95R</b> (EXCAVATORS)		Oil Filter Full Flow.....	O-1901	Fuel Filter.....	FC-1501
Air Filter Secondary.....	A-5540	<b>S-7 SERIES B</b> (SKIDDERS) 3-53		<b>SK05</b> (LOADERS)	
Fuel Filter.....	FC-1016	Fuel Filter.....	F-6505	Air Filter Primary.....	AS-2205
Oil Filter Full Flow.....	C-5204	Fuel Filter Secondary.....	F-6502	Fuel Filter.....	F-5210
		Oil Filter Full Flow.....	O-6503	Fuel Filter.....	F-5214
<b>PW95R-2</b> (EXCAVATORS) KOMATSU 4D106-1FB		<b>S8</b> (SKIDDERS) 3-53		Oil Filter Full Flow.....	C-1011
Fuel/Water Separator.....	SF-52150	Fuel Filter Secondary.....	F-6502	<b>SK07</b> (LOADERS)	
		<b>S8</b> (SKIDDERS) DETROIT DIESEL		Air Filter Primary.....	AS-2205
<b>PW95R-2</b> (EXCAVATORS) KOMATSU 4D106-25FB		Fuel Filter.....	F-6505	Fuel Filter.....	F-5214
Fuel/Water Separator.....	SF-52150	Fuel Filter.....	F-6503	Fuel Filter.....	F-5210
		Oil Filter Full Flow.....	O-6503	Oil Filter Full Flow.....	C-1011
<b>PW95R-2</b> (EXCAVATORS)		<b>S8A</b> (SKIDDERS) D358		<b>SK07 L</b> (LOADERS)	
Air Filter Primary.....	AS-7805	Air Filter Primary.....	AS-7805	Air Filter Primary.....	AS-2205
Air Filter Secondary.....	A-7964	Fuel Filter.....	FC-5403	Fuel Filter.....	F-5210
Fuel Filter.....	FC-1016	<b>S8A</b> (SKIDDERS) D360		Fuel Filter.....	F-5210
Oil Filter Full Flow.....	C-5204	Air Filter Primary.....	AS-7805	Oil Filter Full Flow.....	C-1011
		Fuel Filter.....	FC-7933	<b>SK07J-2</b> (LOADERS)	
<b>PW95R-2</b> (EXCAVATORS) YANMAR 4400DNLCE5		<b>S8A</b> (SKIDDERS) D360		Air Filter Primary.....	AS-2205
Fuel/Water Separator.....	SF-52150	Air Filter Primary.....	AS-7805	Fuel Filter.....	F-5210
		Fuel Filter.....	FC-7933		
<b>PW98MR-8</b> (EXCAVATORS) SAA4D95LE-5 , 2012					
Cabin Air Filter.....	CA-56041				
Oil Filter Full Flow.....	C-56190				
Oil Filter Full Flow.....	C-56191				
<b>PW98MR-8</b> (EXCAVATORS) SAA4D95LE-5					
Hydraulic Oil Filter.....	H-56540				



# Sakura Filter

# ENGINE APPLICATION

MODEL/APPLICATION	SAKURA NO	MODEL/APPLICATION	SAKURA NO	MODEL/APPLICATION	SAKURA NO
<b>KOMATSU</b>		<b>KOMATSU</b>		<b>KOMATSU</b>	
<b>SK09</b> (LOADERS)		<b>SK820-5</b> (LOADERS) S4D84E , 2004		Air Filter Primary.....	AS-5628
Fuel Filter.....	F-5218	Air Filter Primary.....	A-8505	Air Filter Primary.....	A-5628
Fuel Filter.....	F-5210	Air Filter Secondary.....	A-8599	Air Filter Set.....	A-5628-S
Oil Filter Full Flow.....	C-1011			Fuel Filter.....	FC-5704
		<b>SP6000</b> (COMPACTORS)		Oil Filter Full Flow.....	C-6202
<b>SK09J</b> (LOADERS)		Air Filter Primary.....	AS-5628	<b>T-225SL</b> (LOADERS) V-549	
Hydraulic Oil Filter.....	HC-7906	Air Filter Primary.....	A-5628	Oil Filter Full Flow.....	O-6503
		Air Filter Set.....	A-5628-S		
<b>SK1026-5</b> (LOADERS) S4D96E , 2004		<b>SUPER B 45</b> (LOADERS)		<b>T-300SL</b> (LOADERS) V-549	
Air Filter Secondary.....	A-7004	Fuel Filter.....	FC-5103	Oil Filter Full Flow.....	O-6503
Air Filter Set.....	A-8506-S				
Air Filter Primary.....	A-8506	<b>SUPER B 450</b> (LOADERS)		<b>T-400 SERIES A</b> (MOTOR GRADERS) 4-53	
Fuel Filter.....	FC-5201	Fuel Filter.....	FC-5103	Fuel Filter.....	F-6505
Oil Filter Full Flow.....	C-8012			Fuel Filter.....	F-6503
		<b>SUPER BMD</b> (LOADERS)		Oil Filter Full Flow.....	O-6503
<b>SK510-5</b> (LOADERS) 3D84E , 2008		Fuel Filter.....	FC-5103	<b>T-400 SERIES A</b> (MOTOR GRADERS) D407A	
Air Filter Secondary.....	A-5569			Hydraulic Oil Filter Transmission...	H-65030
Air Filter Primary.....	A-8513	<b>SUPER BTD 6</b> (LOADERS)			
Oil Filter Full Flow.....	C-1720	Fuel Filter.....	FC-5103	<b>T500</b> (MOTOR GRADERS) 4-71	
				Fuel Filter.....	F-6505
<b>SK714</b> (LOADERS)		<b>SUPER BWD 6</b> (LOADERS)		Fuel Filter Secondary.....	F-6502
Air Filter Secondary.....	A-5569	Fuel Filter.....	FC-5103	Hydraulic Oil Filter Transmission...	H-65030
Fuel Filter.....	F-5210			Oil Filter Full Flow.....	O-6503
Hydraulic Oil Filter.....	HC-55220	<b>SUPER FCD</b> (TRACTORS)			
Hydraulic Oil Filter.....	HC-5507	Fuel Filter.....	FC-5103	<b>T-500 SERIES A</b> (MOTOR GRADERS) 4-71	
Oil Filter Full Flow.....	C-1011	Fuel Filter.....	F-2601	Fuel Filter.....	F-6505
				Fuel Filter Secondary.....	F-6502
<b>SK714-5</b> (LOADERS)		<b>SUPER W 9</b> (LOADERS)		Hydraulic Oil Filter Transmission...	H-65030
Air Filter Secondary.....	A-5569	Fuel Filter.....	FC-5103	Oil Filter Full Flow.....	O-6503
Fuel Filter.....	F-5210				
Oil Filter Full Flow.....	C-1011	<b>SUPER W6</b> (LOADERS)		<b>T-600</b> (MOTOR GRADERS) 6-71	
		Fuel Filter.....	FC-5103	Fuel Filter.....	F-6505
<b>SK815</b> (LOADERS)				Fuel Filter.....	F-6503
Air Filter Secondary.....	A-5569	<b>SUPER WD 9</b> (LOADERS)		Oil Filter Full Flow.....	O-6503
Fuel Filter.....	F-5210	Fuel Filter.....	FC-5103		
Hydraulic Oil Filter.....	HC-55220			<b>T-600</b> (MOTOR GRADERS) C-160	
Hydraulic Oil Filter.....	HC-5507	<b>SV12</b> (COMPACTORS) F6L413		Fuel Filter.....	F-5701
Oil Filter Full Flow.....	C-1011	Air Filter Primary.....	A-5628	Oil Filter Full Flow.....	O-5702
		Air Filter Set.....	A-5628-S		
<b>SK818-5</b> (LOADERS) KOMATSU , 2004		Air Filter Primary.....	AS-5628	<b>T-600</b> (MOTOR GRADERS) JS-6	
Air Filter Secondary.....	A-5569	Fuel Filter.....	FC-5704	Fuel Filter.....	F-5701
Fuel Filter.....	F-5210	Fuel Filter.....	F-2604	Oil Filter Full Flow.....	O-5702
Hydraulic Oil Filter.....	HC-55220	Oil Filter Full Flow.....	C-6203		
Hydraulic Oil Filter.....	HC-5507	Oil Filter Full Flow.....	C-6204	<b>T-600 SERIES B</b> (MOTOR GRADERS) 6-71	
Oil Filter Full Flow.....	C-1011			Fuel Filter.....	F-6505
		<b>SV7</b> (COMPACTORS) F3L912		Fuel Filter.....	F-6503
<b>SK820-5N</b> (LOADERS) S4D98E-2NFD		Air Filter Primary.....	A-5628	Oil Filter Full Flow.....	O-6503
Air Filter Primary.....	A-8505	Air Filter Set.....	A-5628-S		
Air Filter Secondary.....	A-8599	Air Filter Primary.....	AS-5628	<b>T-600 SERIES B</b> (MOTOR GRADERS) C-160	
Oil Filter Full Flow.....	C-8012	Fuel Filter.....	FC-5704	Fuel Filter.....	F-5701
		Oil Filter Full Flow.....	C-6202	Oil Filter Full Flow.....	O-5702
<b>SK815-5</b> (LOADERS) S4D84E TURBO					
Air Filter Primary.....	A-8505	<b>SV7</b> (COMPACTORS) F4L912		<b>T-600 SERIES B</b> (MOTOR GRADERS) JS-6	
Air Filter Secondary.....	A-8599	Air Filter Primary.....	AS-5628	Fuel Filter.....	F-5701
Fuel Filter.....	F-5210	Fuel Filter.....	FC-5704	Oil Filter Full Flow.....	O-5702

# Sakura Filter

# ENGINE APPLICATION

MODEL/APPLICATION	SAKURA NO	MODEL/APPLICATION	SAKURA NO	MODEL/APPLICATION	SAKURA NO
<b>KOMATSU</b>		<b>KOMATSU</b>		<b>KOMATSU</b>	
<b>T-600 SERIES B</b> (MOTOR GRADERS) JS-6		<b>TC4000</b> (CRANES) VT-903		Fuel/Water Separator.....	SFC-5705
Oil Filter Full Flow.....	0-5702	Coolant Filter.....	WC-5705	<b>TD15B</b> (DOZERS) DT466	
<b>T700</b> (MOTOR GRADERS) CUMMINS		Fuel Filter.....	FC-5702	Air Filter Primary.....	A-5413
Fuel Filter.....	F-5701	Oil Filter Full Flow.....	C-5715	Air Filter Secondary.....	A-5414
Hydraulic Oil Filter Transmission...	H-65030	Oil Filter By Pass.....	C-5718	Air Filter Set.....	A-5660-S
Oil Filter Full Flow.....	0-5702	<b>TC500</b> (CRANES) DEUTZ		Fuel Filter.....	FC-1810
<b>TC1200</b> (CRANES) F12L413 BF12L413		Fuel Filter.....	F-2604	Fuel Filter.....	FC-7933
Fuel Filter.....	F-2604	Fuel Filter.....	FC-5704	Fuel/Water Separator.....	SFC-5705
Fuel Filter.....	FC-6202	Fuel Filter.....	FC-6202	<b>TD15C</b> (DOZERS) D505T	
Fuel Filter.....	F-2603	Fuel Filter.....	F-2603	Air Filter Secondary.....	A-7632
Oil Filter Full Flow.....	C-6204	Oil Filter Full Flow.....	C-6204	Air Filter.....	A-7631
Oil Filter Full Flow.....	C-6203	Oil Filter Full Flow.....	C-6203	Air Filter Set.....	A-7633-S
<b>TC150</b> (CRANES) F8L413F		<b>TC600</b> (CRANES) F10L413		Coolant Filter.....	WC-5705
Fuel Filter.....	FC-5704	Fuel Filter.....	F-2604	Fuel Filter Secondary.....	FC-7903
Oil Filter Full Flow.....	C-6203	Oil Filter Full Flow.....	C-6203	Fuel/Water Separator.....	SFC-5706
Oil Filter Full Flow.....	C-6204	Oil Filter Full Flow.....	C-6204	Fuel/Water Separator.....	SFC-5708
<b>TC2000</b> (CRANES) F12L413 BF12L413		<b>TC600</b> (CRANES) F12L413		Oil Filter Full Flow.....	C-1305
Fuel Filter.....	FC-6202	Fuel Filter.....	F-2604	<b>TD15C</b> (DOZERS) DT407	
Fuel Filter.....	F-2604	Oil Filter Full Flow.....	C-6203	Air Filter Set.....	A-5660-S
Fuel Filter.....	F-2603	Oil Filter Full Flow.....	C-6204	Air Filter Primary.....	A-5413
Oil Filter Full Flow.....	C-6204	<b>TC600</b> (CRANES) F6L413		Fuel Filter.....	FC-7933
Oil Filter Full Flow.....	C-6203	Fuel Filter.....	F-2604	Fuel Filter.....	FC-1810
<b>TC280</b> (CRANES) F10/12L413		Fuel Filter.....	FC-5704	Fuel/Water Separator.....	SFC-5705
Fuel Filter.....	F-2603	Oil Filter Full Flow.....	C-6203	<b>TD15C</b> (DOZERS) DT466	
Fuel Filter.....	F-2604	Oil Filter Full Flow.....	C-6204	Air Filter Primary.....	A-5413
Fuel Filter.....	FC-6202	<b>TC600</b> (CRANES) F8L413		Air Filter Secondary.....	A-5414
Oil Filter Full Flow.....	C-6203	Fuel Filter.....	F-2604	Air Filter Set.....	A-5660-S
Oil Filter Full Flow.....	C-6204	Oil Filter Full Flow.....	C-6203	Fuel Filter.....	FC-1810
<b>TC300</b> (CRANES) F10L413		Oil Filter Full Flow.....	C-6204	Fuel Filter.....	FC-7933
Fuel Filter.....	F-2604	<b>TD12</b> (DOZERS) D466B		Fuel/Water Separator.....	SFC-5705
Oil Filter Full Flow.....	C-6204	Air Filter Primary.....	A-7610	<b>TD15C</b> (DOZERS) DT466B	
Oil Filter Full Flow.....	C-6203	Air Filter Set.....	A-7610-S	Air Filter Primary.....	A-5413
<b>TC300</b> (CRANES) F6L413		Air Filter Secondary.....	A-7608	Air Filter Secondary.....	A-5414
Fuel Filter.....	FC-5704	Fuel Filter.....	FC-7933	Air Filter Set.....	A-5660-S
Oil Filter Full Flow.....	C-6203	Fuel/Water Separator.....	SFC-5705	Fuel Filter.....	FC-1810
Oil Filter Full Flow.....	C-6204	<b>TD12C</b> (DOZERS)		Fuel Filter.....	FC-7933
<b>TC300</b> (CRANES) F8L413		Fuel Filter.....	FC-7933	Fuel/Water Separator.....	SFC-5705
Fuel Filter.....	FC-5704	Fuel/Water Separator.....	SFC-5705	<b>TD15E</b> (DOZERS) DT466C	
Oil Filter Full Flow.....	C-6203	<b>TD15B</b> (DOZERS) DT361		Air Filter Primary.....	A-5413
Oil Filter Full Flow.....	C-6204	Air Filter.....	A-85370	Air Filter Secondary.....	A-5414
<b>TC4000</b> (CRANES) KTA- 600		<b>TD15B</b> (DOZERS) DT407		Air Filter Set.....	A-5660-S
Coolant Filter.....	WC-5705	Air Filter Primary.....	A-5413	Fuel Filter.....	FC-7933
Fuel Filter.....	FC-5720	Air Filter Set.....	A-5660-S	Fuel Filter.....	FC-1810
Fuel/Water Separator.....	SFC-5705	Fuel Filter.....	FC-1810	Fuel/Water Separator.....	SFC-5705
Oil Filter Full Flow.....	C-5715	Fuel Filter.....	FC-7933	<b>TD-180FB</b> (DOZERS) 6V-53	
				Fuel Filter.....	F-6505
				Fuel Filter Secondary.....	F-6502
				Oil Filter Full Flow.....	0-6503
				<b>TD20C</b> (DOZERS) DVT-573B	
				Air Filter Primary.....	A-5420

MODEL/APPLICATION	SAKURA NO	MODEL/APPLICATION	SAKURA NO	MODEL/APPLICATION	SAKURA NO
<b>KOMATSU</b>		<b>KOMATSU</b>		<b>KOMATSU</b>	
<b>TD20C</b> (DOZERS) DVT-573B		<b>TD25G</b> (DOZERS) KT-1150		<b>TD8E</b> (DOZERS) DT239	
Air Filter Set.....	A-5405-S	Coolant Filter.....	WC-5703	Fuel Filter.....	FC-5403
Air Filter Set.....	A-5420-S	Fuel/Water Separator.....	SFC-5709-10	Fuel Filter.....	FC-5103
Air Filter Secondary.....	A-5406	Fuel/Water Separator.....	SFC-5705		
Air Filter Primary.....	A-5405	Oil Filter Full Flow.....	C-5715	<b>TD8G</b> (DOZERS) D240T	
Fuel Filter Secondary.....	FC-54050	Oil Filter By Pass.....	C-5718	Fuel/Water Separator.....	SFC-5708
Fuel/Water Separator.....	SFC-5705			Oil Filter Full Flow.....	C-5703
Oil Filter Full Flow.....	C-5402	<b>TD30</b> (DOZERS)			
		Air Filter.....	A-8545	<b>TG25G</b> (DOZERS) KT-1150	
<b>TD20E</b> (DOZERS) V-800		Hydraulic Oil Filter Transmission....	H-65030	Coolant Filter.....	WC-5705
Air Filter Set.....	A-5420-S			Fuel Filter.....	FC-5702
Air Filter Primary.....	A-5420	<b>TD40</b> (DOZERS) KTA-1150		Oil Filter Full Flow.....	C-5715
Fuel Filter Secondary.....	FC-54050	Coolant Filter.....	WC-5703	Oil Filter By Pass.....	C-5718
Oil Filter Full Flow.....	C-5402	Fuel/Water Separator.....	SFC-5705		
		Fuel/Water Separator.....	SFC-5709-10	<b>UD12</b> (DITCHERS) NT-855	
<b>TD20G</b> (DOZERS) CUMMINS		Oil Filter By Pass.....	C-5718	Coolant Filter.....	WC-5711
Air Filter.....	A-5434	Oil Filter Full Flow.....	C-5715	Fuel Filter.....	FC-5602
Fuel Filter.....	FS-5701			Oil Filter By Pass.....	O-5704
Fuel/Water Separator Secondary...	SFC-1905-10	<b>TD5</b> (DOZERS)		Oil Filter Full Flow.....	C-5605
Fuel/Water Separator.....	SFC-5709-10	Oil Filter Full Flow.....	O-1803	Oil Filter Full Flow.....	C-5701
Fuel/Water Separator.....	SFC-5705			Oil Filter Full Flow.....	C-5715
Oil Filter By Pass.....	C-5718	<b>TD5B</b> (DOZERS)			
Oil Filter Full Flow.....	C-5715	Oil Filter Full Flow.....	O-1803	<b>UD12W</b> (DITCHERS) NT-855	
				Coolant Filter.....	WC-5711
<b>TD-225SL</b> (DOZERS) 6V-53		<b>TD6B SERIES II</b> (DOZERS) D239		Fuel Filter.....	FC-5602
Fuel Filter.....	F-6505	Air Filter Secondary.....	A-76560	Oil Filter By Pass.....	O-5704
Fuel Filter Secondary.....	F-6502			Oil Filter Full Flow.....	C-5605
Oil Filter Full Flow.....	O-6503	<b>TD7</b> (DOZERS)		Oil Filter Full Flow.....	C-5701
		Fuel Filter.....	FC-5103	Oil Filter Full Flow.....	C-5715
<b>TD25-250</b> (DOZERS)		Fuel Filter.....	FC-5403		
Air Filter.....	A-57240	<b>TD7C</b> (DOZERS) D206		<b>V323</b> (LOADERS)	
		Fuel Filter.....	FC-5403	Fuel Filter.....	F-2601
<b>TD25B</b> (DOZERS) DT817				Fuel Filter.....	FC-5103
Air Filter Primary.....	A-5425	<b>TD7E</b> (DOZERS) D239		Oil Filter Full Flow.....	C-1122
Air Filter.....	A-57240	Fuel Filter.....	FC-5403		
Hydraulic Oil Filter Transmission....	H-65030	<b>TD8</b> (DOZERS)		<b>V423</b> (LOADERS)	
		Fuel Filter.....	FC-5403	Fuel Filter.....	F-2603
<b>TD25B</b> (DOZERS) DT817B				Oil Filter Full Flow.....	C-1122
Air Filter Secondary.....	A-5417	<b>TD8B</b> (DOZERS) D239			
Air Filter Primary.....	A-5425	Air Filter Secondary.....	A-76560	<b>VWA 16</b> (COMPACTORS)	
Fuel Filter Secondary.....	FC-54050			Air Filter.....	AS-1010
Fuel/Water Separator.....	SFC-5705	<b>TD8B SERIES II</b> (DOZERS) D239			
		Air Filter Secondary.....	A-76560	<b>VWA 8</b> (COMPACTORS) F6L912	
<b>TD25C</b> (DOZERS) DT817B				Air Filter Primary.....	AS-5628
Fuel Filter Secondary.....	FC-54050	<b>TD8C</b> (DOZERS)		Air Filter Primary.....	A-5628
Fuel/Water Separator.....	SFC-5705	Fuel Filter.....	FC-5103	Air Filter Set.....	A-5628-S
Oil Filter Full Flow.....	C-5402	Fuel Filter.....	FC-5403	Fuel Filter.....	FC-5704
				Oil Filter Full Flow.....	C-6204
<b>TD25E</b> (DOZERS) DT817C		<b>TD8E</b> (DOZERS) D239			
Air Filter Secondary.....	A-5417	Fuel Filter.....	FC-5403	<b>VWA4</b> (COMPACTORS) F3L912	
Fuel Filter Secondary.....	FC-54050	Fuel Filter.....	FC-5103	Air Filter Primary.....	A-5628
Fuel/Water Separator.....	SFC-5705			Air Filter Set.....	A-5628-S
Hydraulic Oil Filter.....	H-5406			Air Filter Primary.....	AS-5628
Hydraulic Oil Filter Transmission....	H-65030			Fuel Filter.....	FC-5704
Oil Filter Full Flow.....	C-5402			Oil Filter Full Flow.....	C-6202

# Sakura Filter

# ENGINE APPLICATION

MODEL/APPLICATION	SAKURA NO	MODEL/APPLICATION	SAKURA NO	MODEL/APPLICATION	SAKURA NO
<b>KOMATSU</b>		<b>KOMATSU</b>		<b>KOMATSU</b>	
<b>VWA4 (COMPACTORS) F4L912</b>		<b>W170-2 (LOADERS) NT-855</b>		<b>W60 (LOADERS) 6B155</b>	
Air Filter Primary.....	A-5628	Coolant Filter.....	WC-5707	Coolant Filter.....	WC-5707
Air Filter Set.....	A-5628-S	Fuel Filter.....	FC-5602	Hydraulic Oil Filter.....	H-5618
Air Filter Primary.....	AS-5628	Oil Filter By Pass.....	O-5704	Hydraulic Oil Filter.....	H-5609
Fuel Filter.....	FC-5704	Oil Filter Full Flow.....	C-5605	Oil Filter Full Flow.....	C-5614
Oil Filter Full Flow.....	C-6202	Oil Filter Full Flow.....	C-5701		
		Oil Filter Full Flow.....	C-5715		
<b>VWT 2 (COMPACTORS) F2L912</b>		<b>W180-1 (LOADERS) NT-855</b>		<b>W60-1 (LOADERS) 6B155</b>	
Air Filter Primary.....	A-5425	Air Filter Secondary.....	A-5610	Coolant Filter.....	WC-5707
Air Filter Primary.....	AS-1014	Air Filter Primary.....	A-5614	Hydraulic Oil Filter.....	H-5618
Fuel Filter.....	FC-6205	Coolant Filter.....	WC-5707	Hydraulic Oil Filter.....	H-5609
		Fuel Filter.....	FC-5602	Oil Filter Full Flow.....	C-5614
		Hydraulic Oil Filter.....	H-5609		
		Hydraulic Oil Filter.....	H-5618		
		Oil Filter Full Flow.....	C-5701		
		Oil Filter By Pass.....	O-5704		
		Oil Filter Full Flow.....	C-5605		
		Oil Filter Full Flow.....	C-5715		
<b>VWT 4 (COMPACTORS) F2L912</b>		<b>W20-1 (LOADERS) 4D92</b>		<b>W60-1 (LOADERS) 6D105</b>	
Air Filter Primary.....	AS-1014	Fuel Filter.....	FC-5604	Coolant Filter.....	WC-5707
Air Filter Primary.....	A-5425	Oil Filter Full Flow.....	C-5606	Hydraulic Oil Filter.....	H-5618
Fuel Filter.....	FC-6205			Hydraulic Oil Filter.....	H-5609
				Oil Filter Full Flow.....	C-5614
<b>VWT 7 (COMPACTORS) F3L912</b>		<b>W260-1 (LOADERS) KT-1150</b>		<b>W70 (LOADERS) 6B155</b>	
Air Filter Primary.....	A-5425	Coolant Filter.....	WC-5705	Coolant Filter.....	WC-5707
Air Filter Primary.....	AS-1014	Fuel Filter.....	FC-5720	Hydraulic Oil Filter.....	H-5618
Fuel Filter.....	FC-5704	Fuel/Water Separator.....	SFC-5705	Hydraulic Oil Filter.....	H-5609
Oil Filter Full Flow.....	C-6202	Hydraulic Oil Filter.....	H-5618	Oil Filter Full Flow.....	C-5614
		Hydraulic Oil Filter.....	H-5609		
		Oil Filter Full Flow.....	C-5715		
		Oil Filter By Pass.....	O-5704		
<b>VWT 9 (COMPACTORS) F3L912</b>		<b>W30-1 (LOADERS) 4D92</b>		<b>W70-1 (LOADERS) 6B155</b>	
Fuel Filter.....	FC-5704	Fuel Filter.....	FC-5604	Coolant Filter.....	WC-5707
Oil Filter Full Flow.....	C-6202	Oil Filter Full Flow.....	C-5606	Hydraulic Oil Filter.....	H-5609
				Hydraulic Oil Filter.....	H-5618
				Oil Filter Full Flow.....	C-5614
<b>W120-1 (LOADERS) PD6T</b>		<b>W40-1 (LOADERS) 4D105-3</b>		<b>W70-1 (LOADERS) 6D105</b>	
Hydraulic Oil Filter.....	H-5618	Fuel Filter.....	FC-5604	Coolant Filter.....	WC-5707
		Hydraulic Oil Filter.....	H-5618	Hydraulic Oil Filter.....	H-5618
		Oil Filter Full Flow.....	C-5614	Hydraulic Oil Filter.....	H-5609
				Oil Filter Full Flow.....	C-5614
<b>W120-2 (LOADERS) SAGD110</b>		<b>W40-1 (LOADERS) 4D92</b>		<b>W70-1 (LOADERS) KOMATSU 6D105-1</b>	
Coolant Filter.....	WC-5707	Fuel Filter.....	FC-5604	Fuel Filter.....	FC-5601
Fuel Filter.....	FC-5602	Hydraulic Oil Filter.....	H-5618		
Hydraulic Oil Filter.....	H-5618	Oil Filter Full Flow.....	C-5614		
Hydraulic Oil Filter.....	H-5609				
Oil Filter Full Flow.....	C-5614				
<b>W120-3 (LOADERS) SAGD110</b>		<b>W40-2 (LOADERS) 4D105-3</b>		<b>W70-2 (LOADERS) 6B155</b>	
Coolant Filter.....	WC-5707	Fuel Filter.....	FC-5604	Coolant Filter.....	WC-5707
Fuel Filter.....	FC-5602	Hydraulic Oil Filter.....	H-5618	Hydraulic Oil Filter.....	H-5618
Hydraulic Oil Filter.....	H-5618	Oil Filter Full Flow.....	C-5614	Hydraulic Oil Filter.....	H-5609
Hydraulic Oil Filter.....	H-5609			Oil Filter Full Flow.....	C-5614
Oil Filter Full Flow.....	C-5614				
<b>W170-1 (LOADERS) V-903</b>		<b>W40-2 (LOADERS) 4D92</b>		<b>W70-2 (LOADERS) 6D105</b>	
Coolant Filter.....	WC-5713	Fuel Filter.....	FC-5604	Coolant Filter.....	WC-5707
Fuel Filter.....	F-5701	Hydraulic Oil Filter.....	H-5618	Hydraulic Oil Filter.....	H-5618
Oil Filter By Pass.....	O-5704	Oil Filter Full Flow.....	C-5614	Hydraulic Oil Filter.....	H-5609
Oil Filter Full Flow.....	O-5702			Oil Filter Full Flow.....	C-5614

# Sakura Filter

# ENGINE APPLICATION

MODEL/APPLICATION	SAKURA NO	MODEL/APPLICATION	SAKURA NO	MODEL/APPLICATION	SAKURA NO
<b>KOMATSU</b>		<b>KOMATSU</b>		<b>KOMATSU</b>	
<b>W90-1</b> (LOADERS) CUMMINS V-504		Air Filter Primary.....	A-8665M	Cabin Air Filter.....	CA-56100
Fuel Filter.....	FC-5721	Cabin Air Filter.....	CA-56100	<b>WA120-CS3</b> (LOADERS) 6D95L-1/10004	
<b>W90-1</b> (LOADERS) V-504		Fuel/Water Separator.....	SFC-5601-02	Air Filter Primary.....	AS-7805
Coolant Filter.....	WC-5705	Hydraulic Oil Filter.....	H-85680	Air Filter Secondary.....	A-7806
Fuel Filter.....	FC-5702	Hydraulic Oil Filter.....	H-2709	Fuel Filter.....	FC-1801
Fuel/Water Separator Secondary... SFC-1905-10		Hydraulic Oil Filter.....	H-5652	Oil Filter Full Flow.....	C-5606
Fuel/Water Separator.....	SFC-5709-10	Hydraulic Oil Filter.....	H-7911	<b>WA120-LC</b> (LOADERS)	
Fuel/Water Separator.....	SFC-5705	<b>WA120-1</b> (LOADERS) 410T		Air Filter Set.....	AS-8502-S
Oil Filter Full Flow.....	O-5703	Oil Filter Full Flow.....	C-5615	Air Filter Secondary.....	A-5437
Oil Filter By Pass.....	C-5718	Oil Filter Full Flow.....	C-5616	Air Filter Primary.....	AS-8502
Oil Filter Full Flow.....	C-5715	<b>WA120-1</b> (LOADERS) 6D95L-1/10001		Fuel Filter Secondary.....	FC-7903
Oil Filter By Pass.....	O-5704	Air Filter Secondary.....	A-7806	Fuel/Water Separator.....	SFC-5708
Oil Filter Full Flow.....	C-1305	Air Filter Primary.....	AS-7805	Fuel/Water Separator.....	SFC-5706
<b>W90-2</b> (LOADERS) S6D105-1		Hydraulic Oil Filter.....	H-5607	Hydraulic Oil Filter.....	H-5607
Air Filter Primary.....	A-5413	Hydraulic Oil Filter.....	H-5618	Hydraulic Oil Filter.....	H-5618
Air Filter Set.....	A-5660-S	Oil Filter Full Flow.....	C-5604	Oil Filter Full Flow.....	C-5703
Coolant Filter.....	WC-5707	<b>WA120-2L</b> (LOADERS) A30001		<b>WA150-1</b> (LOADERS) S6D95L	
Hydraulic Oil Filter.....	H-5609	Air Filter Set.....	A-5663-S	Oil Filter Full Flow.....	C-5615
Hydraulic Oil Filter.....	H-5618	Air Filter Secondary.....	A-6008	Oil Filter Full Flow.....	C-5616
Oil Filter Full Flow.....	C-5614	Air Filter Primary.....	A-5627	<b>WA150-1</b> (LOADERS) S6D95L-1/10001	
<b>W90-3</b> (LOADERS) S6D105-1		Fuel Filter Secondary.....	FC-7903	Air Filter Primary.....	AS-1024
Air Filter Primary.....	A-5413	Fuel/Water Separator.....	SFC-5706	Air Filter Secondary.....	A-6009
Air Filter Set.....	A-5660-S	Fuel/Water Separator.....	SFC-5708	Air Filter Set.....	AS-1024-S
Coolant Filter.....	WC-5707	Hydraulic Oil Filter.....	H-5607	Fuel Filter.....	FC-5604
Hydraulic Oil Filter.....	H-5609	Hydraulic Oil Filter.....	H-5618	Hydraulic Oil Filter.....	H-5618
Hydraulic Oil Filter.....	H-5618	<b>WA120-3</b> (LOADERS) 6D95L-1/50001 - 52999		Hydraulic Oil Filter.....	H-5607
Oil Filter Full Flow.....	C-5614	Air Filter Secondary.....	A-7806	Hydraulic Oil Filter.....	H-5652
<b>WA100-1</b> (LOADERS) 6D95L-1/10001		Air Filter Primary.....	AS-7805	Oil Filter Full Flow.....	C-5604
Air Filter Secondary.....	A-6009	Fuel Filter.....	FC-1801	<b>WA150-5</b> (LOADERS) KOMATSU SAA4D102E-2	
Air Filter Secondary.....	A-7806	Hydraulic Oil Filter.....	H-5618	Air Filter Primary.....	A-56731
Air Filter Primary.....	AS-7805	Hydraulic Oil Filter.....	H-5607	Air Filter Set.....	A-56731-S
Air Filter Primary.....	AS-1024	Oil Filter Full Flow.....	C-5606	<b>WA150-5</b> (LOADERS) SAA4D102E-2	
Air Filter Set.....	AS-1024-S	<b>WA120-3</b> (LOADERS) 6D95L-1/ALL		Air Filter Primary.....	A-5673
Hydraulic Oil Filter.....	H-5652	Air Filter Primary.....	AS-7805	Air Filter Secondary.....	A-5674
Hydraulic Oil Filter.....	H-5607	Air Filter Secondary.....	A-7806	Air Filter Set.....	A-5675-S
Hydraulic Oil Filter.....	H-5618	Coolant Filter.....	WC-5707	Fuel Filter.....	F-5218
Oil Filter Full Flow.....	C-5604	Fuel Filter Secondary.....	FC-7903	Fuel Filter.....	FC-5621
<b>WA100M</b> (LOADERS)		Fuel/Water Separator.....	SFC-5708	<b>WA150L-5</b> (LOADERS) KOMATSU SAA4D102E-2	
Air Filter Primary.....	A-5541	Hydraulic Oil Filter.....	H-5607	Air Filter Primary.....	A-56731
Air Filter Secondary.....	A-5540	Hydraulic Oil Filter.....	H-5618	Air Filter Set.....	A-56731-S
Coolant Filter.....	WC-56010	Oil Filter Full Flow.....	C-5703	<b>WA150L-5</b> (LOADERS) SAA4D102E-2	
Fuel/Water Separator.....	SFC-5601-02	<b>WA120-3</b> (LOADERS)		Air Filter Primary.....	A-5673
<b>WA115-3</b> (LOADERS)		Air Filter Primary.....	A-5627	Air Filter Secondary.....	A-5674
Fuel Filter.....	FC-1016	Air Filter Secondary.....	A-6008	Air Filter Set.....	A-5675-S
Oil Filter Full Flow.....	C-5204	Air Filter Set.....	A-5663-S	Fuel Filter.....	F-5218
<b>WA1200-3</b> (LOADERS) QSK60		Cabin Air Filter.....	CA-56100	Fuel Filter.....	FC-5621
Air Filter Secondary.....	A-8580	Fuel Filter Secondary.....	FC-7903	<b>WA180-1</b> (LOADERS) S6D95L-1/26330	
Air Filter Secondary.....	A-5610	Fuel/Water Separator.....	SFC-5708	Air Filter Primary.....	AS-1024
Air Filter Primary.....	A-5614	Hydraulic Oil Filter.....	H-5618	<b>WA180-1</b> (LOADERS) S6D95L-1/26330	
		Hydraulic Oil Filter.....	H-5607	Air Filter Primary.....	AS-1024
		<b>WA120-3</b> (LOADERS) w/S4D102E Eng.			

MODEL/APPLICATION	SAKURA NO	MODEL/APPLICATION	SAKURA NO	MODEL/APPLICATION	SAKURA NO
<b>KOMATSU</b>		<b>KOMATSU</b>		<b>KOMATSU</b>	
<b>WA180-1</b> (LOADERS) S6D95L-1/26330		Fuel/Water Separator.....	SFC-5708	<b>WA150-3</b> (LOADERS) w/S6D102E-1D Eng.	
Air Filter Set.....	AS-1024-S	Hydraulic Oil Filter.....	H-5618	Cabin Air Filter.....	CA-56100
Coolant Filter.....	WC-5707	Hydraulic Oil Filter.....	H-5607		
Fuel Filter.....	FC-5604	Oil Filter Full Flow.....	C-5730		
Hydraulic Oil Filter.....	H-5607			<b>WA150-6</b> (LOADERS) SAA4D95LE-5	
Hydraulic Oil Filter.....	H-5618	<b>WA180-3L</b> (LOADERS) S/N: A80001		Air Filter Secondary.....	A-5674
Oil Filter Full Flow.....	C-5604	Air Filter Secondary.....	A-5635		
		Air Filter Primary.....	A-5639	<b>WA150PZ-6</b> (LOADERS) SAA4D95LE-5	
<b>WA180-1LC</b> (LOADERS)		Cabin Air Filter.....	CA-56100	Air Filter Secondary.....	A-5674
Air Filter Set.....	A-5662-S	Fuel Filter Secondary.....	FC-7903		
Air Filter Primary.....	A-1313	Fuel/Water Separator.....	SFC-5708	<b>WA200-1</b> (LOADERS) 6D105-1/10001	
Air Filter Secondary.....	A-1307	Fuel/Water Separator.....	SFC-5706	Air Filter Set.....	A-5604-S
Fuel Filter Secondary.....	FC-7903	Hydraulic Oil Filter.....	H-5607	Air Filter Secondary.....	A-5606
Fuel/Water Separator.....	SFC-5706	Hydraulic Oil Filter.....	H-5618	Air Filter Secondary.....	A-6009
Fuel/Water Separator.....	SFC-5708			Air Filter Primary.....	A-5605
Hydraulic Oil Filter.....	H-5618	<b>WA180PT-3</b> (LOADERS) S6D102E		Air Filter Primary.....	AS-1024
Hydraulic Oil Filter.....	H-5607	Air Filter Secondary.....	A-5635	Air Filter Set.....	AS-1024-S
Oil Filter Full Flow.....	C-5730	Air Filter Primary.....	A-5639	Hydraulic Oil Filter.....	H-5607
		Fuel Filter Secondary.....	FC-7903	Hydraulic Oil Filter.....	H-5652
<b>WA180-3</b> (LOADERS) S6D102E		Fuel/Water Separator.....	SFC-5708	Hydraulic Oil Filter.....	H-5618
Air Filter Secondary.....	A-5635	Hydraulic Oil Filter.....	H-5607	Oil Filter Full Flow.....	C-5614
Air Filter Primary.....	A-5639	Hydraulic Oil Filter.....	H-5618		
Fuel Filter Secondary.....	FC-7903			<b>WA200-5</b> (LOADERS) KOMATSU SAA6D102E-2	
Fuel/Water Separator.....	SFC-5708	<b>WA100M-6</b> (LOADERS) SAA4D95LE-5 , 2008		Hydraulic Oil Filter.....	HC-56060
Hydraulic Oil Filter.....	H-5618	Oil Filter Full Flow.....	C-56190		
Hydraulic Oil Filter.....	H-5607	Oil Filter Full Flow.....	C-56191	<b>WA200-5</b> (LOADERS) SAA6D102E-2	
				Air Filter Secondary.....	A-8578
<b>WA180-3</b> (LOADERS) S6D102E/53001		<b>WA1200-6</b> (LOADERS) SAADA16V160E-2 , 2011		Air Filter Primary.....	A-8577
Air Filter Primary.....	A-5639	Air Filter Secondary.....	A-5610	Cabin Air Filter.....	CA-5602
Air Filter Secondary.....	A-5635	Air Filter Primary.....	A-5614	Fuel Filter.....	F-5218
Fuel Filter Secondary.....	FC-7903	Air Filter Secondary.....	A-8580	Oil Filter Full Flow.....	C-5611
Fuel/Water Separator.....	SFC-5708	Air Filter Primary.....	A-8665M		
Hydraulic Oil Filter.....	H-5618	Cabin Air Filter.....	CA-56100	<b>WA200-5L</b> (LOADERS) KOMATSU SAA6D102E-2	
Hydraulic Oil Filter.....	H-5607	Hydraulic Oil Filter.....	H-85680	Air Filter Primary.....	A-56731
Oil Filter Full Flow.....	C-5730	Hydraulic Oil Filter.....	H-2709	Air Filter Set.....	A-56731-S
		Hydraulic Oil Filter.....	H-5652		
<b>WA180-3</b> (LOADERS) S6D95L-1/50001/52999		Hydraulic Oil Filter.....	H-7911	<b>WA200-5L</b> (LOADERS) SAA6D102E-2	
Air Filter Secondary.....	A-6009	<b>WA100-5</b> (LOADERS) KOMATSU SAA4D102E-2G		Air Filter Primary.....	A-5673
Air Filter Primary.....	AS-1024	Air Filter Secondary.....	A-56741	Air Filter Set.....	A-5675-S
Air Filter Set.....	AS-1024-S	Air Filter Primary.....	A-56731	Air Filter Secondary.....	A-5674
Fuel Filter.....	FC-1801	Air Filter Set.....	A-56731-S	Cabin Air Filter.....	CA-5602
Hydraulic Oil Filter.....	H-5618			Fuel Filter.....	F-5218
Hydraulic Oil Filter.....	H-5607	<b>WA100-5</b> (LOADERS) SAA4D102E-2G		Oil Filter Full Flow.....	C-5611
Oil Filter Full Flow.....	C-5606	Air Filter Secondary.....	A-5674		
		Air Filter Set.....	A-5675-S	<b>WA200-6</b> (LOADERS) KOMATSU SAA4D107E	
<b>WA180-3D</b> (LOADERS) S6D102E		Air Filter Primary.....	A-5673	Air Filter Primary.....	A-56731
Air Filter Secondary.....	A-5635	Air Filter Secondary.....	A-8670	Air Filter Set.....	A-56731-S
Air Filter Primary.....	A-5639	Cabin Air Filter.....	CA-5676	Air Filter Secondary.....	A-56741
Fuel Filter Secondary.....	FC-7903	Fuel Filter.....	F-5218		
Fuel/Water Separator.....	SFC-5708			<b>WA200-6</b> (LOADERS) SAA4D107E	
Hydraulic Oil Filter.....	H-5618	<b>WA100M-5</b> (LOADERS) S4D95		Air Filter Set.....	A-5675-S
Hydraulic Oil Filter.....	H-5607	Air Filter Secondary.....	A-5540	Air Filter Secondary.....	A-5674
		Air Filter Primary.....	A-5541	Air Filter Primary.....	A-5673
<b>WA180-3D</b> (LOADERS) S6D102E-1W/53001		Fuel Filter.....	F-5214	Air Filter Secondary.....	A-8670
Air Filter Secondary.....	A-5635	Oil Filter Full Flow.....	C-56190	Fuel Filter.....	FC-5613
Air Filter Primary.....	A-5639	Oil Filter Full Flow.....	C-56191	Oil Filter Full Flow.....	C-5611
Fuel Filter Secondary.....	FC-7903				

MODEL/APPLICATION	SAKURA NO	MODEL/APPLICATION	SAKURA NO	MODEL/APPLICATION	SAKURA NO
<b>KOMATSU</b>		<b>KOMATSU</b>		<b>KOMATSU</b>	
<b>WA200-6</b> (LOADERS) SAA4D107E-1		Air Filter Secondary.....	A-5606	<b>WA250PT-5</b> (LOADERS) SAA6D102E , 2004	
Air Filter Breather.....	A-82010	Air Filter Primary.....	A-5605	Air Filter Primary.....	A-8577
Fuel Filter.....	F-56040	Air Filter Set.....	A-5604-S	Air Filter Secondary.....	A-8578
<b>WA200L-5</b> (LOADERS) SAA6D102E-2		Coolant Filter.....	WC-5707	Cabin Air Filter.....	CA-5602
Air Filter Primary.....	A-8577	Hydraulic Oil Filter.....	H-5607	Cabin Air Filter.....	CA-5676
Air Filter Secondary.....	A-8578	Hydraulic Oil Filter.....	H-5618	Fuel Filter.....	F-5218
Cabin Air Filter.....	CA-5602	Oil Filter Full Flow.....	C-5614	Oil Filter Full Flow.....	C-5611
Fuel Filter.....	F-5218	<b>WA250-3</b> (LOADERS) S6D95L-1/50001		<b>WA270</b> (LOADERS) S/N: N270H20907	
Oil Filter Full Flow.....	C-5611	Air Filter Primary.....	AS-1024	Air Filter Secondary.....	A-8578
<b>WA200PT-5L</b> (LOADERS) KOMATSU SAA6D102E-2		Air Filter Set.....	AS-1024-S	Fuel Filter Secondary.....	FC-7903
Air Filter Primary.....	A-56731	Air Filter Secondary.....	A-6009	Fuel/Water Separator.....	SFC-5708
Air Filter Set.....	A-56731-S	Fuel Filter.....	FC-1801	Hydraulic Oil Filter Transmission...	HC-2701
<b>WA200PT-5L</b> (LOADERS) SAA6D102E-2		Hydraulic Oil Filter.....	H-5607	Oil Filter Full Flow.....	C-5730
Air Filter Set.....	A-5675-S	Hydraulic Oil Filter.....	H-5618	<b>WA270-3</b> (LOADERS) S6D102E	
Air Filter Secondary.....	A-5674	Oil Filter Full Flow.....	C-5606	Air Filter Secondary.....	A-8578
Air Filter Primary.....	A-5673	<b>WA250-3</b> (LOADERS) S6D95L-1/13714		Fuel Filter Secondary.....	FC-7903
Cabin Air Filter.....	CA-5602	Air Filter Primary.....	AS-1024	Fuel/Water Separator.....	SFC-5708
Fuel Filter.....	F-5218	Air Filter Set.....	AS-1024-S	Fuel/Water Separator.....	SFC-5706
Oil Filter Full Flow.....	C-5611	Fuel Filter.....	FC-1801	Hydraulic Oil Filter Transmission...	HC-2701
<b>WA20-1</b> (LOADERS) 3D78-1		Hydraulic Oil Filter.....	H-5618	<b>WA270-30</b> (LOADERS)	
Air Filter Primary.....	AS-2205	Hydraulic Oil Filter.....	H-5607	Air Filter Secondary.....	A-8578
Fuel Filter.....	F-5210	Oil Filter Full Flow.....	C-5606	Hydraulic Oil Filter Transmission..	HC-76130
Oil Filter Full Flow.....	C-1720	<b>WA250-3L</b> (LOADERS) A87000		<b>WA270-3H</b> (LOADERS)	
<b>WA250</b> (LOADERS) 6B5.9		Air Filter Secondary.....	A-5635	Air Filter Secondary.....	A-8578
Air Filter Primary.....	A-2210	Air Filter Primary.....	A-5639	Fuel Filter Secondary.....	FC-7903
Air Filter Primary.....	A-5639	Fuel Filter Secondary.....	FC-7903	Fuel/Water Separator.....	SFC-5706
Air Filter Secondary.....	A-6008	Fuel/Water Separator.....	SFC-5708	Fuel/Water Separator.....	SFC-5708
Fuel Filter Secondary.....	FC-7903	Fuel/Water Separator.....	SFC-5706	Oil Filter Full Flow.....	C-5730
Fuel/Water Separator.....	SFC-5708	Hydraulic Oil Filter.....	H-5607	<b>WA200PZ-6</b> (LOADERS) SAA4D107E	
Fuel/Water Separator.....	SFC-5706	<b>WA250-3L</b> (LOADERS) w/S6D102E Eng.		Air Filter Secondary.....	A-5674
Hydraulic Oil Filter.....	H-5607	Cabin Air Filter.....	CA-56100	Fuel Filter.....	FC-5613
Oil Filter Full Flow.....	C-5730	<b>WA250-5H</b> (LOADERS)		<b>WA200PZ-6</b> (LOADERS) SAA6D107E-1	
<b>WA250-1</b> (LOADERS) CUMMINS		Cabin Air Filter.....	CA-5602	Air Filter Secondary.....	A-5667
Air Filter Secondary.....	A-6008	Cabin Air Filter.....	CA-5676	Air Filter Primary.....	A-5666
Fuel Filter Secondary.....	FC-7903	Fuel Filter.....	F-5218	<b>WA250-5</b> (LOADERS) SAA6D102E , 2004	
Fuel/Water Separator.....	SFC-5708	<b>WA250-6</b> (LOADERS) SAA6D107E		Air Filter Secondary.....	A-8578
Fuel/Water Separator.....	SFC-5706	Air Filter Primary.....	A-5666	Air Filter Primary.....	A-8577
Hydraulic Oil Filter.....	H-5607	Air Filter Secondary.....	A-5667	Cabin Air Filter.....	CA-5676
Hydraulic Oil Filter.....	H-5618	Fuel Filter.....	FC-5613	Cabin Air Filter.....	CA-5602
Oil Filter Full Flow.....	C-5730	Oil Filter Full Flow.....	C-5611	Fuel Filter.....	F-5218
<b>WA250-1</b> (LOADERS) S6D105-1/10001		<b>WA250PT</b> (LOADERS) 2006		Oil Filter Full Flow.....	C-5611
Air Filter Primary.....	A-5605	Air Filter Secondary.....	A-8578	<b>WA250PZ-6</b> (LOADERS) SAA6D107E	
Air Filter Set.....	A-5604-S	Air Filter Primary.....	A-8577	Air Filter Secondary.....	A-5667
Air Filter Secondary.....	A-5606	Cabin Air Filter.....	CA-5602	Air Filter Primary.....	A-5666
Hydraulic Oil Filter.....	H-5607	Cabin Air Filter.....	CA-5676	Cabin Air Filter.....	CA-5676
Hydraulic Oil Filter.....	H-5652	Fuel Filter.....	FC-5621	Oil Filter Full Flow.....	C-5611
Oil Filter Full Flow.....	C-5614	Oil Filter Full Flow.....	C-5611	<b>WA200-3</b> (LOADERS) w/S6D102E-1 Eng.	
<b>WA250-1</b> (LOADERS) S6D105-1/86423					

# Sakura Filter

# ENGINE APPLICATION

MODEL/APPLICATION	SAKURA NO	MODEL/APPLICATION	SAKURA NO	MODEL/APPLICATION	SAKURA NO
<b>KOMATSU</b>		<b>KOMATSU</b>		<b>KOMATSU</b>	
<b>WA200-3</b> (LOADERS) w/S6D102E-1 Eng. Cabin Air Filter.....	CA-56100	Air Filter Set.....	A-5604-S	Fuel Filter.....	FC-5602
<b>WA250-3MC</b> (LOADERS) w/S6D102E Eng. Cabin Air Filter.....	CA-56100	Air Filter Secondary.....	A-5635	Hydraulic Oil Filter.....	H-5618
<b>WA320-3H</b> (LOADERS) Air Filter Secondary.....	A-7105	Air Filter Secondary.....	A-5606	Hydraulic Oil Filter.....	H-5652
Air Filter Set.....	A-5662-S	Air Filter Primary.....	A-5639	Hydraulic Oil Filter.....	H-5609
Air Filter Primary.....	A-1313	Air Filter Primary.....	A-5605	Oil Filter Full Flow.....	C-5614
Air Filter Primary.....	A-7106	Hydraulic Oil Filter.....	H-5610	<b>WA320-3</b> (LOADERS) S6D108-1G/53001	
Air Filter Secondary.....	A-1307	Hydraulic Oil Filter.....	H-5609	Air Filter Secondary.....	A-1307
Fuel Filter Secondary.....	FC-7903	Hydraulic Oil Filter.....	H-5652	Air Filter Primary.....	A-1313
Fuel/Water Separator.....	SFC-5706	Oil Filter Full Flow.....	C-5608	Air Filter Set.....	A-5662-S
Fuel/Water Separator.....	SFC-5708	Oil Filter Full Flow.....	C-5614	Fuel Filter.....	FC-5602
Hydraulic Oil Filter.....	H-5618	<b>WA320-1</b> (LOADERS) S6D105-1/94068		Hydraulic Oil Filter.....	H-5609
Oil Filter Combination.....	C-7927	Air Filter Secondary.....	A-5635	Hydraulic Oil Filter.....	H-5618
<b>WA300-1</b> (LOADERS) S6D105-1/10001		Air Filter Primary.....	A-5639	Hydraulic Oil Filter.....	H-5652
Air Filter Primary.....	A-5605	Coolant Filter.....	WC-5707	Oil Filter Full Flow.....	C-5614
Air Filter Set.....	A-5604-S	Hydraulic Oil Filter.....	H-5652	<b>WA320-3</b> (LOADERS) S6D114E	
Air Filter Secondary.....	A-5606	Hydraulic Oil Filter.....	H-5618	Air Filter Secondary.....	A-1307
Hydraulic Oil Filter.....	H-56600	Hydraulic Oil Filter.....	H-5609	Air Filter Primary.....	A-1313
Hydraulic Oil Filter.....	H-5610	Oil Filter Full Flow.....	C-5614	Air Filter Set.....	A-5662-S
Hydraulic Oil Filter.....	H-5618	<b>WA320-1</b> (LOADERS) S6D105-1/86535/94067		Coolant Filter.....	WC-5705
Hydraulic Oil Filter.....	H-5652	Air Filter Set.....	A-5604-S	Fuel/Water Separator.....	SFC-5706
Oil Filter Full Flow.....	C-5614	Air Filter Primary.....	A-5605	Hydraulic Oil Filter.....	H-5618
<b>WA300-3L</b> (LOADERS) A53001		Air Filter Secondary.....	A-5606	Hydraulic Oil Filter.....	H-5609
Hydraulic Oil Filter.....	H-56770	Coolant Filter.....	WC-5707	Oil Filter Combination.....	C-7927
<b>WA300-3L</b> (LOADERS) S/N: A53001		Hydraulic Oil Filter.....	H-5610	<b>WA320-3</b> (LOADERS) SA6D102E	
Air Filter Secondary.....	A-5635	Hydraulic Oil Filter.....	H-5618	Hydraulic Oil Filter.....	H-56700
Air Filter Primary.....	A-5639	Hydraulic Oil Filter.....	H-56600	<b>WA320-3CS</b> (LOADERS) SA6D102E-1B/50001	
Fuel Filter Secondary.....	FC-7903	Oil Filter Full Flow.....	C-5614	Air Filter Primary.....	A-5639
Fuel/Water Separator.....	SFC-5708	<b>WA320-11C</b> (LOADERS)		Air Filter Secondary.....	A-5635
Hydraulic Oil Filter.....	H-5652	Air Filter Secondary.....	A-1307	Fuel Filter Secondary.....	FC-7903
Hydraulic Oil Filter.....	H-5609	Air Filter Primary.....	A-1313	Fuel/Water Separator.....	SFC-5708
Oil Filter Full Flow.....	C-5730	Air Filter Set.....	A-5662-S	Hydraulic Oil Filter.....	H-5609
<b>WA30-2</b> (LOADERS) YANMAR/3001		Cabin Air Filter.....	CA-56100	Hydraulic Oil Filter.....	H-5618
Air Filter Primary.....	AS-2205	Coolant Filter.....	WC-5706	Hydraulic Oil Filter.....	H-5652
Fuel Filter.....	F-5207	Fuel Filter Secondary.....	FC-7903	Oil Filter Full Flow.....	C-5730
Oil Filter Full Flow.....	C-1920	Fuel/Water Separator.....	SFC-5706	<b>WA320-3LE</b> (LOADERS) S6D114E-1/A30001	
<b>WA30-5</b> (LOADERS) 3D84E		Fuel/Water Separator.....	SFC-5708	Air Filter Secondary.....	A-1307
Fuel Filter.....	F-5207	Hydraulic Oil Filter.....	H-5607	Air Filter Primary.....	A-1313
Oil Filter Full Flow.....	C-5204	Hydraulic Oil Filter.....	H-5618	Air Filter Set.....	A-5662-S
<b>WA30-5</b> (LOADERS) 3D84E-3		Hydraulic Oil Filter.....	H-5652	Coolant Filter.....	WC-5705
Air Filter Primary.....	A-8513	Oil Filter Combination.....	C-7927	Fuel Filter Secondary.....	FC-7903
Air Filter Primary.....	AS-2205	<b>WA320-2</b> (LOADERS) CUMMINS , 1996		Fuel/Water Separator.....	SFC-5708
Fuel Filter.....	F-5210	Fuel Filter Secondary.....	FC-7903	Fuel/Water Separator.....	SFC-5706
Oil Filter Full Flow.....	C-8012	Fuel/Water Separator.....	SFC-5706	Oil Filter Full Flow.....	C-5730
<b>WA320-1</b> (LOADERS) S6D105-1/10001		Oil Filter Full Flow.....	C-5730	<b>WA320-5</b> (LOADERS) KOMATSU	
Air Filter Primary.....	A-5605	<b>WA320-3</b> (LOADERS) S6D108-1/50001 - 52999		Air Filter Secondary.....	A-8578
Air Filter Set.....	A-5604-S	Air Filter Set.....	A-5662-S	Air Filter Primary.....	A-8577
Air Filter Secondary.....	A-5606	Air Filter Secondary.....	A-1307	Cabin Air Filter.....	CA-5602
Hydraulic Oil Filter.....	H-56600	Air Filter Primary.....	A-1313	Cabin Air Filter.....	CA-5676
Hydraulic Oil Filter.....	H-5610			Oil Filter Full Flow.....	C-5611
Hydraulic Oil Filter.....	H-5618				
Hydraulic Oil Filter.....	H-5652				
Oil Filter Full Flow.....	C-5614				



# Sakura Filter

# ENGINE APPLICATION

MODEL/APPLICATION	SAKURA NO	MODEL/APPLICATION	SAKURA NO	MODEL/APPLICATION	SAKURA NO
<b>KOMATSU</b>		<b>KOMATSU</b>		<b>KOMATSU</b>	
<b>WA320-6</b> (LOADERS) KOMATSU SAA6D107E-1 Fuel/Water Separator.....	SFC-19100	Oil Filter Full Flow.....	C-5614	Hydraulic Oil Filter.....	H-5652
<b>WA320-6</b> (LOADERS) SAA6D107E Air Filter Primary.....	A-5666	<b>WA380-1</b> (LOADERS) SA6D110-1/56994 Air Filter Set.....	A-5662-S	Oil Filter Full Flow.....	C-5614
Air Filter Secondary.....	A-5667	Air Filter Primary.....	A-1313	<b>WA380-3</b> (LOADERS) S6D108-1/53001 Air Filter Set.....	A-5662-S
Fuel Filter.....	FC-5613	Air Filter Secondary.....	A-1307	Air Filter Secondary.....	A-1307
Oil Filter Full Flow.....	C-5611	Coolant Filter.....	WC-5707	Fuel Filter Primary.....	A-1313
<b>WA350-1</b> (LOADERS) S6D110-1/10001 Air Filter Set.....	A-5604-S	Fuel Filter.....	FC-5602	Fuel Filter.....	FC-5602
Air Filter Primary.....	A-5605	Hydraulic Oil Filter.....	H-5618	Hydraulic Oil Filter.....	H-5618
Air Filter Secondary.....	A-5606	Hydraulic Oil Filter.....	H-5652	Hydraulic Oil Filter.....	H-5609
Coolant Filter.....	WC-5707	Hydraulic Oil Filter.....	H-5609	Hydraulic Oil Filter.....	H-5652
Fuel Filter.....	FC-5621	Oil Filter Full Flow.....	C-5614	Oil Filter Full Flow.....	C-5614
Hydraulic Oil Filter.....	H-5609	<b>WA380-1</b> (LOADERS) w/Cummins 8.3L Eng. Cabin Air Filter.....	CA-56100	<b>WA380-3</b> (LOADERS) S6D108-1 Fuel Filter.....	FC-5606
Hydraulic Oil Filter.....	H-5618	<b>WA380-11C</b> (LOADERS) 614T Air Filter Primary.....	A-10134	<b>WA380-3H</b> (LOADERS) Air Filter Primary.....	A-5558M
Oil Filter Full Flow.....	C-5614	Air Filter Primary.....	A-1013	Air Filter Secondary.....	A-5559
<b>WA350-1</b> (LOADERS) S/N: 10001 Air Filter Secondary.....	A-5606	Air Filter Secondary.....	A-5631	Air Filter Set.....	A-5558M-S
Air Filter Primary.....	A-5605	Air Filter Set.....	A-1841-S	Fuel Filter Secondary.....	FC-7903
Air Filter Set.....	A-5604-S	Cabin Air Filter.....	CA-56100	Fuel/Water Separator.....	SFC-5708
Hydraulic Oil Filter.....	H-5618	Fuel Filter Secondary.....	FC-7903	Fuel/Water Separator.....	SFC-5706
Hydraulic Oil Filter.....	H-5609	Fuel/Water Separator.....	SFC-5708	Hydraulic Oil Filter.....	H-5618
Oil Filter Full Flow.....	C-5614	Fuel/Water Separator.....	SFC-5706	Oil Filter Combination.....	C-7927
<b>WA380-1</b> (LOADERS) SAGD110-1/10001 Air Filter Primary.....	A-6113	Hydraulic Oil Filter.....	H-5618	<b>WA380-3LC</b> (LOADERS) A50001 Air Filter Primary.....	A-10134
Air Filter Secondary.....	A-5408	Hydraulic Oil Filter.....	H-5652	Air Filter Set.....	A-1841-S
Air Filter Set.....	A-5662-S	Hydraulic Oil Filter.....	H-5618	Air Filter Primary.....	A-1013
Air Filter Primary.....	A-1313	Hydraulic Oil Filter.....	H-5609	Air Filter Secondary.....	A-5631
Air Filter Secondary.....	A-1307	Oil Filter Full Flow.....	C-5614	Coolant Filter.....	WC-5705
Fuel Filter.....	FC-5621	<b>WA380-11C</b> (LOADERS) Cabin Air Filter.....	CA-56100	Fuel Filter Secondary.....	FC-7903
Hydraulic Oil Filter.....	H-5652	Coolant Filter.....	WC-5706	Fuel Filter Secondary.....	FC-7903
Hydraulic Oil Filter.....	H-5618	Fuel Filter Secondary.....	FC-7903	Fuel/Water Separator.....	SFC-5708
Hydraulic Oil Filter.....	H-5609	Fuel/Water Separator.....	SFC-5708	Hydraulic Oil Filter.....	H-56770
Oil Filter Full Flow.....	C-5614	Fuel/Water Separator.....	SFC-5706	Hydraulic Oil Filter.....	H-5609
<b>WA380-1</b> (LOADERS) SAGD110-1/55205/56993 Air Filter Primary.....	A-6113	Hydraulic Oil Filter.....	H-56770	Oil Filter Combination.....	C-7927
Air Filter Secondary.....	A-5408	Hydraulic Oil Filter.....	H-5618	<b>WA380-3LE</b> (LOADERS) S6D114E-1/A50001 Air Filter Primary.....	A-10134
Coolant Filter.....	WC-5707	Hydraulic Oil Filter.....	H-5652	Air Filter Primary.....	A-1013
Fuel Filter.....	FC-5602	Hydraulic Oil Filter.....	H-5609	Air Filter Secondary.....	A-5631
Hydraulic Oil Filter.....	H-5618	Oil Filter Full Flow.....	C-1305	Air Filter Set.....	A-1841-S
Hydraulic Oil Filter.....	H-5609	<b>WA380-3</b> (LOADERS) S6D108-1/20188 Air Filter Secondary.....	A-1307	Coolant Filter.....	WC-5705
Hydraulic Oil Filter.....	H-5652	Air Filter Primary.....	A-1313	Fuel Filter Secondary.....	FC-7903
Oil Filter Full Flow.....	C-5614	Air Filter Set.....	A-5662-S	Fuel/Water Separator.....	SFC-5708
<b>WA380-1</b> (LOADERS) SAGD110-1/54352/55205 Air Filter Primary.....	A-6113	Fuel Filter.....	FC-5602	Hydraulic Oil Filter.....	H-56770
Air Filter Secondary.....	A-5408	Hydraulic Oil Filter.....	H-5618	Hydraulic Oil Filter.....	H-5609
Coolant Filter.....	WC-5707	Hydraulic Oil Filter.....	H-5652	Oil Filter Combination.....	C-7927
Fuel Filter.....	FC-5602	Hydraulic Oil Filter.....	H-5609	<b>WA380-3MC</b> (LOADERS) A51001 Air Filter Primary.....	A-10134
Hydraulic Oil Filter.....	H-5652	Oil Filter Full Flow.....	C-5614	Air Filter Set.....	A-1841-S
Hydraulic Oil Filter.....	H-5618	<b>WA380-3</b> (LOADERS) S6D108-1/50001 - 52999 Air Filter Set.....	A-5662-S	Air Filter Primary.....	A-1013
Hydraulic Oil Filter.....	H-5609	Air Filter Secondary.....	A-1307	Air Filter Secondary.....	A-5631
<b>WA380-1</b> (LOADERS) SAGD110-1/54352/55205 Air Filter Primary.....	A-6113	Air Filter Primary.....	A-1313	Cabin Air Filter.....	CA-56100
Air Filter Secondary.....	A-5408	Fuel Filter.....	FC-5602	Cabin Air Filter Set.....	CA-5601-S
Coolant Filter.....	WC-5707	Hydraulic Oil Filter.....	H-5618	Cabin Air Filter Set.....	CA-5603-S
Fuel Filter.....	FC-5602	Hydraulic Oil Filter.....	H-5609		
Hydraulic Oil Filter.....	H-5652				
Hydraulic Oil Filter.....	H-5618				
Hydraulic Oil Filter.....	H-5609				

# Sakura Filter

# ENGINE APPLICATION

MODEL/APPLICATION	SAKURA NO	MODEL/APPLICATION	SAKURA NO	MODEL/APPLICATION	SAKURA NO
<b>KOMATSU</b>		<b>KOMATSU</b>		<b>KOMATSU</b>	
<b>WA380-3MC</b> (LOADERS) A51001		<b>WA400-1</b> (LOADERS) SA6D110-1/10001		Coolant Filter.....	WC-5705
Fuel Filter Secondary.....	FC-7903	Air Filter Secondary.....	A-5408	Fuel Filter Secondary.....	FC-7903
Fuel/Water Separator.....	SFC-5708	Air Filter Primary.....	A-6113	Fuel/Water Separator.....	SFC-5706
Fuel/Water Separator.....	SFC-5706	Fuel Filter.....	FC-5602	Fuel/Water Separator.....	SFC-5708
Hydraulic Oil Filter.....	H-56770	Hydraulic Oil Filter.....	H-5618	Hydraulic Oil Filter.....	H-5618
Hydraulic Oil Filter.....	H-5609	Hydraulic Oil Filter.....	H-5652	Hydraulic Oil Filter.....	H-5609
Hydraulic Oil Filter.....	H-5618	Hydraulic Oil Filter.....	H-5609	Oil Filter Combination.....	C-7927
Oil Filter Combination.....	C-7927	Oil Filter Full Flow.....	C-5614		
<b>WA380-5</b> (LOADERS) 2003		<b>WA400-1</b> (LOADERS) SA6D110		<b>WA420-1</b> (LOADERS) SA6D110-1/54110/56996	
Air Filter Primary.....	A-5558M	Fuel Filter.....	FC-5606	Air Filter Secondary.....	A-5408
Air Filter Secondary.....	A-5559			Air Filter Primary.....	A-6113
Air Filter Set.....	A-5558M-S	<b>WA400-5</b> (LOADERS) KOMATSU SAA6D114E		Coolant Filter.....	WC-5707
Cabin Air Filter.....	CA-5676	Fuel Filter.....	FC-5610	Fuel Filter.....	FC-5602
Hydraulic Oil Filter.....	H-7911			Hydraulic Oil Filter.....	H-5618
Hydraulic Oil Filter.....	H-85680	<b>WA400-5</b> (LOADERS) SAA6D114E		Hydraulic Oil Filter.....	H-5652
		Air Filter Set.....	A-5558M-S	Hydraulic Oil Filter.....	H-5609
<b>WA380-6</b> (LOADERS) 2006		Air Filter Primary.....	A-5558M	Oil Filter Full Flow.....	C-5614
Air Filter Secondary.....	A-5559	Air Filter Secondary.....	A-5559		
Air Filter Set.....	A-5558M-S	Cabin Air Filter.....	CA-5602	<b>WA420-1</b> (LOADERS) SA6D110	
Hydraulic Oil Filter.....	H-56650	Hydraulic Oil Filter.....	H-85680	Fuel Filter.....	FC-5606
Oil Filter Full Flow.....	C-5611	Hydraulic Oil Filter.....	H-7911		
<b>WA380-6</b> (LOADERS) CUMMINS QSB6.7		<b>WA400-5L</b> (LOADERS) KOMATSU SAA6D114E		<b>WA420-1</b> (LOADERS) SA6D110-1/56997	
Fuel Filter.....	FC-5613	Fuel Filter.....	FC-5610	Air Filter Secondary.....	A-1307
		<b>WA400-5L</b> (LOADERS) SAA6D114E		Air Filter Primary.....	A-1313
<b>WA380-6</b> (LOADERS) KOMATSU SAA6D107E-1		Air Filter Set.....	A-5558M-S	Air Filter Set.....	A-5662-S
Hydraulic Oil Filter.....	H-56652	Air Filter Primary.....	A-5558M	Coolant Filter.....	WC-5707
		Air Filter Secondary.....	A-5559	Fuel Filter.....	FC-5602
<b>WA380-6</b> (LOADERS) SAA6D107E		Cabin Air Filter.....	CA-5602	Hydraulic Oil Filter.....	H-5652
Fuel Filter.....	FC-5613	Hydraulic Oil Filter.....	H-85680	Hydraulic Oil Filter.....	H-5618
		Hydraulic Oil Filter.....	H-7911	Hydraulic Oil Filter.....	H-5609
<b>WA380H</b> (LOADERS)		<b>WA400-5WH</b> (LOADERS) KOMATSU SAA6D114E		Oil Filter Full Flow.....	C-5614
Fuel Filter Secondary.....	FC-7903	Fuel Filter.....	FC-5610		
Fuel/Water Separator.....	SFC-5708	<b>WA400-5WH</b> (LOADERS) SAA6D114E		<b>WA420-1</b> (LOADERS) w/Cummins Eng	
Fuel/Water Separator.....	SFC-5706	Air Filter Set.....	A-5558M-S	Cabin Air Filter.....	CA-56100
Hydraulic Oil Filter.....	H-5618	Air Filter Primary.....	A-5558M		
Oil Filter Combination.....	C-7927	Air Filter Secondary.....	A-5559	<b>WA420-1LC</b> (LOADERS)	
		Cabin Air Filter.....	CA-5602	Air Filter Set.....	A-1841-S
<b>WA380-7</b> (LOADERS) SAA6D107E-2 , 2011		Hydraulic Oil Filter.....	H-85680	Air Filter Primary.....	A-1013
Oil Filter Full Flow.....	C-5611	Hydraulic Oil Filter.....	H-7911	Air Filter Secondary.....	A-5631
				Air Filter Primary.....	A-10134
<b>WA320PZ-6</b> (LOADERS) SAA6D107E-1		<b>WA40-1</b> (LOADERS) 1001		Fuel Filter Secondary.....	FC-7903
Air Filter Secondary.....	A-5667	Air Filter Primary.....	AS-1014	Fuel/Water Separator.....	SFC-5706
Air Filter Primary.....	A-5666	Hydraulic Oil Filter.....	HC-5602	Fuel/Water Separator.....	SFC-5708
		Oil Filter Full Flow.....	C-5604	Hydraulic Oil Filter.....	H-5618
<b>WA300-3</b> (LOADERS) w/SA6D102E Eng.		<b>WA420-1</b> (LOADERS) 614T		Hydraulic Oil Filter.....	H-5652
Cabin Air Filter.....	CA-56100	Air Filter Primary.....	A-1013	Hydraulic Oil Filter.....	H-5609
		Air Filter Secondary.....	A-5631	Hydraulic Oil Filter.....	H-56770
<b>WA350-3</b> (LOADERS) S6D108		Air Filter Set.....	A-1841-S	Oil Filter Combination.....	C-7927
Fuel Filter.....	FC-5606	Air Filter Primary.....	A-10134		
		Air Filter Secondary.....	A-5603	<b>WA420-3</b> (LOADERS) A31001	
<b>WA350-3</b> (LOADERS) w/S6D108 Eng.		Air Filter Set.....	A-1841-S	Air Filter Secondary.....	A-5631
Cabin Air Filter.....	CA-56100	Air Filter Primary.....	A-10134	Air Filter Set.....	A-1841-S
		Cabin Air Filter.....	CA-56100	Air Filter Primary.....	A-1013

MODEL/APPLICATION	SAKURA NO	MODEL/APPLICATION	SAKURA NO	MODEL/APPLICATION	SAKURA NO
<b>KOMATSU</b>		<b>KOMATSU</b>		<b>KOMATSU</b>	
<b>WA420-3</b> <b>(LOADERS)</b> <b>A31001</b>		Oil Filter Combination.....	C-7927	Hydraulic Oil Filter.....	H-5609
Fuel/Water Separator.....	SFC-5708	<b>WA420-3CS</b> <b>(LOADERS)</b> <b>WA6D114-1AA/R50001</b>		Oil Filter Full Flow.....	C-5715
Fuel/Water Separator.....	SFC-5706	Coolant Filter.....	WC-5703	Oil Filter Full Flow.....	C-5701
Hydraulic Oil Filter.....	H-5618	Fuel Filter Secondary.....	FC-7903	Oil Filter Full Flow.....	C-5605
Hydraulic Oil Filter.....	H-56770	Fuel/Water Separator.....	SFC-5708		
Hydraulic Oil Filter.....	H-5609	Hydraulic Oil Filter.....	H-5609	<b>WA450-2</b> <b>(LOADERS)</b> <b>CUMMINS LTA10 A25001</b>	
Oil Filter Combination.....	C-7927	Hydraulic Oil Filter.....	H-5618	Hydraulic Oil Filter.....	H-56770
		Hydraulic Oil Filter.....	H-5652		
<b>WA420-3</b> <b>(LOADERS)</b> <b>SAGD108</b>		Oil Filter Combination.....	C-5723	<b>WA450-2</b> <b>(LOADERS)</b> <b>LTA10/A25001</b>	
Air Filter Primary.....	A-1313	<b>WA420-3H</b> <b>(LOADERS)</b>		Air Filter Primary.....	A-10134
Air Filter Secondary.....	A-1307	Air Filter Primary.....	A-1013	Air Filter Primary.....	A-1013
Air Filter Set.....	A-5662-S	Air Filter Secondary.....	A-5631	Air Filter Set.....	A-1841-S
Fuel Filter.....	FC-5606	Air Filter Set.....	A-5558M-S	Coolant Filter.....	WC-5705
Fuel Filter.....	FC-5602	Air Filter Primary.....	A-10134	Fuel Filter.....	FC-5720
Hydraulic Oil Filter.....	H-5652	Air Filter Primary.....	A-5558M	Fuel/Water Separator.....	SFC-5705
Hydraulic Oil Filter.....	H-5609	Air Filter Secondary.....	A-5559	Hydraulic Oil Filter.....	H-5618
Hydraulic Oil Filter.....	H-5618	Air Filter Set.....	A-1841-S	Hydraulic Oil Filter.....	H-5609
Oil Filter Full Flow.....	C-5614	Fuel Filter Secondary.....	FC-7903	Oil Filter Combination.....	C-5723
		Fuel/Water Separator.....	SFC-5708		
<b>WA420-3</b> <b>(LOADERS)</b> <b>SAGD108-1/50001/52999</b>		Fuel/Water Separator.....	SFC-5706	<b>WA450-2</b> <b>(LOADERS)</b> <b>w/Cummins Eng</b>	
Air Filter Primary.....	A-1313	Hydraulic Oil Filter.....	H-5618	Cabin Air Filter.....	CA-56100
Air Filter Secondary.....	A-1307	Oil Filter Combination.....	C-7927		
Air Filter Set.....	A-5662-S	<b>WA420-3LE</b> <b>(LOADERS)</b> <b>A30001</b>		<b>WA450-3</b> <b>(LOADERS)</b> <b>LTA10</b>	
Fuel Filter.....	FC-5602	Air Filter Set.....	A-1841-S	Air Filter Secondary.....	A-5610
Hydraulic Oil Filter.....	H-5652	Air Filter Primary.....	A-10134	Air Filter Primary.....	A-5614
Hydraulic Oil Filter.....	H-5618	Air Filter Primary.....	A-1013	Fuel Filter.....	FC-5602
Hydraulic Oil Filter.....	H-5609	Air Filter Secondary.....	A-5631	Hydraulic Oil Filter.....	H-5652
Oil Filter Full Flow.....	C-5614	Fuel Filter Secondary.....	FC-7903	Hydraulic Oil Filter.....	H-5618
		Fuel/Water Separator.....	SFC-5708	Hydraulic Oil Filter.....	H-5609
<b>WA420-3</b> <b>(LOADERS)</b> <b>SA6D108-1/53001</b>		Hydraulic Oil Filter.....	H-5609	Oil Filter Full Flow.....	C-5715
Air Filter Primary.....	A-1313	Hydraulic Oil Filter.....	H-5618	Oil Filter Full Flow.....	C-5605
Air Filter Secondary.....	A-1307	Oil Filter Combination.....	C-7927	Oil Filter Full Flow.....	C-5701
Air Filter Set.....	A-5662-S	<b>WA450-1</b> <b>(LOADERS)</b> <b>S6D125-1</b>			
Fuel Filter.....	FC-5621	Fuel Filter.....	FC-5606	<b>WA450-3</b> <b>(LOADERS)</b> <b>MTA11</b>	
Hydraulic Oil Filter.....	H-5652			Coolant Filter.....	WC-5713
Hydraulic Oil Filter.....	H-5609	<b>WA450-1</b> <b>(LOADERS)</b> <b>S6D125-1/10001</b>		Fuel/Water Separator.....	SFC-5705
Hydraulic Oil Filter.....	H-5618	Air Filter Primary.....	A-10134	Fuel/Water Separator.....	SFC-5709-10
Oil Filter Full Flow.....	C-5614	Air Filter Set.....	A-1841-S	Hydraulic Oil Filter.....	H-5618
		Air Filter Primary.....	A-1013	Hydraulic Oil Filter.....	H-5609
<b>WA420-3</b> <b>(LOADERS)</b> <b>SA6D114E-1/19467</b>		Air Filter Secondary.....	A-5631	Oil Filter Combination.....	C-5723
Air Filter Primary.....	A-1313	Fuel Filter Secondary.....	FC-7903		
Air Filter Secondary.....	A-1307	Fuel/Water Separator.....	SFC-5708	<b>WA450-3LE</b> <b>(LOADERS)</b> <b>A30001</b>	
Air Filter Set.....	A-5662-S	Hydraulic Oil Filter.....	H-5609	Coolant Filter.....	WC-5713
Fuel Filter.....	FC-5602	Hydraulic Oil Filter.....	H-5618	Fuel/Water Separator.....	SFC-5705
Hydraulic Oil Filter.....	H-5652	Oil Filter Combination.....	C-7927	Fuel/Water Separator.....	SFC-5709-10
Hydraulic Oil Filter.....	H-5618	<b>WA450-1</b> <b>(LOADERS)</b> <b>S6D125-1/11574</b>		Hydraulic Oil Filter.....	H-5618
Hydraulic Oil Filter.....	H-5609	Air Filter Primary.....	A-6113	Hydraulic Oil Filter.....	H-5609
Oil Filter Full Flow.....	C-5614	Air Filter Secondary.....	A-5408	Hydraulic Oil Filter.....	H-5618
		Fuel Filter.....	FC-5602	Oil Filter Combination.....	C-5723
<b>WA420-3</b> <b>(LOADERS)</b> <b>SAA6D114E-1</b>		Hydraulic Oil Filter.....	H-5618		
Air Filter Secondary.....	A-5631	Hydraulic Oil Filter.....	H-5652	<b>WA450-3LL</b> <b>(LOADERS)</b> <b>S6D125-1</b>	
Air Filter Set.....	A-1841-S			Fuel Filter.....	FC-5606
Air Filter Primary.....	A-1013	<b>WA450-1</b> <b>(LOADERS)</b> <b>S6D125-1/50305</b>			
Air Filter Primary.....	A-10134	Air Filter Primary.....	A-6113	<b>WA450-3LL</b> <b>(LOADERS)</b> <b>S6D125-1/11574</b>	
Coolant Filter.....	WC-5705	Air Filter Secondary.....	A-5408	Air Filter Primary.....	A-10134
Hydraulic Oil Filter.....	H-5618	Fuel Filter.....	FC-5602	Air Filter Primary.....	A-1013
Hydraulic Oil Filter.....	H-5609	Hydraulic Oil Filter.....	H-5618	Air Filter Secondary.....	A-5631
		Hydraulic Oil Filter.....	H-5652	Air Filter Set.....	A-1841-S
				Fuel Filter.....	FC-5602

MODEL/APPLICATION	SAKURA NO	MODEL/APPLICATION	SAKURA NO	MODEL/APPLICATION	SAKURA NO
<b>KOMATSU</b>		<b>KOMATSU</b>		<b>KOMATSU</b>	
<b>WA450-3LL</b> (LOADERS) S6D125-1/50305		Oil Filter Full Flow.....	C-5701	Oil Filter Full Flow.....	C-5701
Hydraulic Oil Filter.....	H-5652	<b>WA470-1</b> (LOADERS) S6D125-1KK/10001/19999		<b>WA470-3</b> (LOADERS) S6D125-1AM/50001 - 52999	
Hydraulic Oil Filter.....	H-5618	Air Filter Primary.....	A-1013	Air Filter Set.....	A-1841-S
Hydraulic Oil Filter.....	H-5609	Air Filter Secondary.....	A-5631	Air Filter Secondary.....	A-5631
Oil Filter Full Flow.....	C-5605	Air Filter Primary.....	A-6113	Air Filter Primary.....	A-10134
Oil Filter Full Flow.....	C-5701	Air Filter Primary.....	A-10134	Air Filter Primary.....	A-1013
Oil Filter Full Flow.....	C-5715	Air Filter Set.....	A-1841-S	Fuel Filter.....	FC-5602
<b>WA450-3LL</b> (LOADERS) S6D125-1/53001		Air Filter Secondary.....	A-5408	Hydraulic Oil Filter.....	H-5618
Air Filter Primary.....	A-10134	Fuel Filter.....	FC-5602	Hydraulic Oil Filter.....	H-5652
Air Filter Primary.....	A-1013	Hydraulic Oil Filter.....	H-5609	Hydraulic Oil Filter.....	H-5609
Air Filter Secondary.....	A-5631	Hydraulic Oil Filter.....	H-5618	Oil Filter Full Flow.....	C-5715
Air Filter Set.....	A-1841-S	Oil Filter Full Flow.....	C-5715	Oil Filter Full Flow.....	C-5605
Fuel Filter.....	FC-5602	Oil Filter Full Flow.....	C-5701	Oil Filter Full Flow.....	C-5605
Hydraulic Oil Filter.....	H-5652	Oil Filter Full Flow.....	C-5605	<b>WA470-3</b> (LOADERS) S6D125-1AM/53001	
Hydraulic Oil Filter.....	H-5618	<b>WA470-1</b> (LOADERS) S6D125-1Z/10001/19999		Air Filter Primary.....	A-10134
Oil Filter Full Flow.....	C-5715	Air Filter Primary.....	A-1013	Air Filter Set.....	A-1841-S
Oil Filter Full Flow.....	C-5605	Air Filter Secondary.....	A-5631	Air Filter Primary.....	A-1013
Oil Filter Full Flow.....	C-5701	Air Filter Primary.....	A-6113	Air Filter Secondary.....	A-5631
<b>WA450-6</b> (LOADERS) KOMATSU SAA6D125E-5D		Air Filter Primary.....	A-10134	Fuel Filter.....	FC-5602
Fuel/Water Separator.....	SFC-56020	Air Filter Set.....	A-1841-S	Hydraulic Oil Filter.....	H-5618
Fuel/Water Separator.....	SFC-56020B	Air Filter Secondary.....	A-5408	Hydraulic Oil Filter.....	H-5652
<b>WA450-6</b> (LOADERS) SAA6D125E-5		Fuel Filter.....	FC-5602	Hydraulic Oil Filter.....	H-5609
Air Filter Primary.....	A-5558M	Hydraulic Oil Filter.....	H-5652	Oil Filter Full Flow.....	C-5715
Air Filter Secondary.....	A-5559	Hydraulic Oil Filter.....	H-5609	Oil Filter Full Flow.....	C-5605
Air Filter Set.....	A-5558M-S	Hydraulic Oil Filter.....	H-5618	Oil Filter Full Flow.....	C-5701
Fuel/Water Separator Secondary..	SFC-5611-10	Oil Filter Full Flow.....	C-5715	<b>WA470-3H</b> (LOADERS) M11	
Fuel/Water Separator Secondary..	SFC-5611-10B	Oil Filter Full Flow.....	C-5701	Air Filter Set.....	A-5558M-S
<b>WA450L-3</b> (LOADERS) SAGD125E		Oil Filter Full Flow.....	C-5605	Air Filter Primary.....	A-5558M
Fuel Filter.....	FC-5606	<b>WA470-1</b> (LOADERS) S6D125-1Z/20001		Air Filter Secondary.....	A-5559
Fuel Filter.....	FC-5602	Air Filter Primary.....	A-1013	Coolant Filter.....	WC-5705
Hydraulic Oil Filter.....	H-5618	Air Filter Primary.....	A-6113	Fuel/Water Separator.....	SFC-5709-10
Hydraulic Oil Filter.....	H-5609	Air Filter Set.....	A-1841-S	Fuel/Water Separator.....	SFC-5705
Oil Filter Full Flow.....	C-5715	Air Filter Secondary.....	A-5408	Hydraulic Oil Filter.....	H-5652
Oil Filter Full Flow.....	C-5605	Air Filter Primary.....	A-10134	Hydraulic Oil Filter.....	H-5618
Oil Filter Full Flow.....	C-5701	Air Filter Secondary.....	A-5631	Oil Filter Combination.....	C-5723
<b>WA470-1</b> (LOADERS) S6D125-1		Fuel Filter.....	FC-5602	<b>WA470-3H</b> (LOADERS)	
Fuel Filter.....	FC-5606	Hydraulic Oil Filter.....	H-5652	Air Filter Secondary.....	A-5631
<b>WA470-1</b> (LOADERS) S6D125-1KK/20001		Hydraulic Oil Filter.....	H-5609	Fuel Filter.....	FC-5602
Air Filter Primary.....	A-6113	Hydraulic Oil Filter.....	H-5618	Hydraulic Oil Filter.....	H-5618
Air Filter Set.....	A-1841-S	Oil Filter Full Flow.....	C-5605	Hydraulic Oil Filter.....	H-5609
Air Filter Secondary.....	A-5408	Oil Filter Full Flow.....	C-5701	Oil Filter Full Flow.....	C-5715
Air Filter Primary.....	A-10134	Oil Filter Full Flow.....	C-5715	Oil Filter Full Flow.....	C-5701
Air Filter Secondary.....	A-5631	<b>WA470-3</b> (LOADERS) S6D125-1		Oil Filter Full Flow.....	C-5605
Air Filter Primary.....	A-1013	Air Filter Secondary.....	A-5631	<b>WA470-5</b> (LOADERS) SAA6D125E-3 , 2001	
Air Filter Secondary.....	A-5631	Air Filter Set.....	A-1841-S	Air Filter Primary.....	A-5558M
Fuel Filter.....	FC-5602	Air Filter Primary.....	A-1013	Air Filter Secondary.....	A-5559
Hydraulic Oil Filter.....	H-5609	Air Filter Primary.....	A-10134	Air Filter Set.....	A-5558M-S
Hydraulic Oil Filter.....	H-5652	Fuel Filter.....	FC-5602	Fuel/Water Separator.....	SFC-5601-02
Hydraulic Oil Filter.....	H-5618	Fuel Filter.....	FC-5606	Hydraulic Oil Filter.....	H-2709
Oil Filter Full Flow.....	C-5715	Hydraulic Oil Filter.....	H-5618	<b>WA470-5H</b> (LOADERS)	
Oil Filter Full Flow.....	C-5605	Hydraulic Oil Filter.....	H-5609	Air Filter Primary.....	A-5558M
<b>WA470-1</b> (LOADERS) S6D125-1		Oil Filter Full Flow.....	C-5715	Air Filter Secondary.....	A-5559
Fuel Filter.....	FC-5606	Oil Filter Full Flow.....	C-5605		

# Sakura Filter

# ENGINE APPLICATION

MODEL/APPLICATION	SAKURA NO	MODEL/APPLICATION	SAKURA NO	MODEL/APPLICATION	SAKURA NO
<b>KOMATSU</b>		<b>KOMATSU</b>		<b>KOMATSU</b>	
<b>WA470-5H</b> (LOADERS)		<b>WA470-6</b> (LOADERS) KOMATSU SAA6D125E-5D-01		<b>WA470-6A</b> (LOADERS) KOMATSU SAA6D125E-5	
Air Filter Set.....	A-5558M-S	Oil Filter Transmission.....	TC-56010	Fuel/Water Separator.....	SFC-56020
Cabin Air Filter.....	CA-5676			Fuel/Water Separator.....	SFC-56020B
Cabin Air Filter.....	CA-5602				
Hydraulic Oil Filter.....	H-2709				
<b>WA480-5</b> (LOADERS) KOMATSU SAA6D125E-3		<b>WA430-6</b> (LOADERS) SAA6D114E-3 , 2007		<b>WA470-6A</b> (LOADERS) KOMATSU SAA6D125E-5D	
Fuel Filter.....	FC-5622	Air Filter Set.....	A-5558M-S	Fuel/Water Separator.....	SFC-56020
Hydraulic Oil Filter.....	H-56770	Air Filter Primary.....	A-5558M	Fuel/Water Separator.....	SFC-56020B
		Air Filter Secondary.....	A-5559		
		Cabin Air Filter.....	CA-5676		
		Hydraulic Oil Filter.....	H-56650		
<b>WA480-5</b> (LOADERS) SAA6D125E-3		<b>WA430-6</b> (LOADERS) SAA6D114E-3		<b>WA470-6-LC</b> (LOADERS) KOMATSU SAA6D125E-5	
Air Filter Primary.....	A-5558M	Fuel Filter.....	FC-5613	Fuel/Water Separator.....	SFC-56020B
Air Filter Secondary.....	A-5559			Fuel/Water Separator.....	SFC-56020
Air Filter Set.....	A-5558M-S				
Cabin Air Filter.....	CA-5602				
Cabin Air Filter.....	CA-5676				
Fuel/Water Separator.....	SFC-5601-02				
<b>WA480-5L</b> (LOADERS) KOMATSU SAA6D125E-3		<b>WA450-5L</b> (LOADERS) SAA6D125E-3		<b>WA470-6-LC</b> (LOADERS) KOMATSU SAA6D125E-5D	
Hydraulic Oil Filter.....	H-56770	Air Filter Set.....	A-5558M-S	Fuel/Water Separator.....	SFC-56020
		Air Filter Primary.....	A-5558M	Fuel/Water Separator.....	SFC-56020B
		Air Filter Secondary.....	A-5559		
		Cabin Air Filter.....	CA-5602		
		Cabin Air Filter.....	CA-5676		
		Fuel/Water Separator.....	SFC-5601-02		
		Hydraulic Oil Filter.....	H-2709		
<b>WA480-5L</b> (LOADERS) SAA6D125E-3		<b>WA450-5WH</b> (LOADERS) SAA6D125E-3		<b>WA480-6A</b> (LOADERS) KOMATSU SAA6D125E-5E	
Air Filter Primary.....	A-5558M	Air Filter Set.....	A-5558M-S	Fuel/Water Separator.....	SFC-56020
Air Filter Secondary.....	A-5559	Air Filter Primary.....	A-5558M	Fuel/Water Separator.....	SFC-56020B
Air Filter Set.....	A-5558M-S	Air Filter Secondary.....	A-5559		
Cabin Air Filter.....	CA-5676	Cabin Air Filter.....	CA-5676		
Cabin Air Filter.....	CA-5602	Cabin Air Filter.....	CA-5602		
Fuel/Water Separator.....	SFC-5601-02	Fuel/Water Separator.....	SFC-5601-02		
		Hydraulic Oil Filter.....	H-2709		
<b>WA450-5</b> (LOADERS) SAA6D125E-3		<b>WA480-6</b> (LOADERS) SAA6D125E-5 , 2008		<b>WA480-6H</b> (LOADERS) KOMATSU SAA6D125E-5E	
Air Filter Primary.....	A-5558M	Air Filter Set.....	A-5558M-S	Fuel/Water Separator.....	SFC-56020
Air Filter Secondary.....	A-5559	Air Filter Primary.....	A-5558M	Fuel/Water Separator.....	SFC-56020B
Air Filter Set.....	A-5558M-S	Air Filter Secondary.....	A-5559		
Cabin Air Filter.....	CA-5676	Cabin Air Filter.....	CA-5676		
Cabin Air Filter.....	CA-5602	Cabin Air Filter.....	CA-5602		
Fuel/Water Separator.....	SFC-5601-02	Fuel/Water Separator.....	SFC-5601-02		
Hydraulic Oil Filter.....	H-2709	Hydraulic Oil Filter.....	H-2709		
<b>WA470-6</b> (LOADERS) SAA6D125E-5 , 2008		<b>WA480-6</b> (LOADERS) KOMATSU SAA6D125E-5E		<b>WA500-1</b> (LOADERS) NTA855-C	
Air Filter Primary.....	A-5558M	Fuel/Water Separator.....	SFC-56020B	Air Filter Primary.....	A-5614
Air Filter Secondary.....	A-5559	Fuel/Water Separator.....	SFC-56020	Hydraulic Oil Filter.....	H-5618
Air Filter Set.....	A-5558M-S			Hydraulic Oil Filter.....	H-5609
Cabin Air Filter.....	CA-5676			Oil Filter By Pass.....	C-5718
Fuel/Water Separator Secondary..	SFC-5611-10B			Oil Filter Full Flow.....	C-5715
Fuel/Water Separator Secondary..	SFC-5611-10				
Hydraulic Oil Filter.....	H-5629				
Hydraulic Oil Filter.....	H-5646				
<b>WA470-6</b> (LOADERS) KOMATSU SAA6D125E-5D		<b>WA400-3</b> (LOADERS) w/SA6D108-1C, SAA6D108E-2B Engs.		<b>WA500-1</b> (LOADERS) S6D140-1/10001	
Fuel/Water Separator.....	SFC-56020B	Cabin Air Filter.....	CA-56100	Air Filter Secondary.....	A-5610
Fuel/Water Separator.....	SFC-56020			Air Filter Primary.....	A-5614
				Cabin Air Filter.....	CA-56100
				Fuel Filter.....	FC-5703
				Fuel/Water Separator.....	SFC-5707
				Hydraulic Oil Filter.....	H-5609
				Hydraulic Oil Filter.....	H-5652
				Oil Filter Full Flow.....	C-5715
				Oil Filter Full Flow.....	C-5701
				Oil Filter Full Flow.....	C-5605
<b>WA470-6</b> (LOADERS) KOMATSU SAA6D125E-5D		<b>WA400-3A</b> (LOADERS) w/SA6D108-1C, SAA6D108E-2B Engs.		<b>WA500-1</b> (LOADERS) S6D140-1/10001	
Fuel/Water Separator.....	SFC-56020B	Cabin Air Filter.....	CA-56100	Air Filter Secondary.....	A-5610
Fuel/Water Separator.....	SFC-56020			Air Filter Primary.....	A-5614
				Cabin Air Filter.....	CA-56100
				Fuel Filter.....	FC-5703
				Fuel/Water Separator.....	SFC-5707
				Hydraulic Oil Filter.....	H-5609
				Hydraulic Oil Filter.....	H-5652
				Oil Filter Full Flow.....	C-5715
				Oil Filter Full Flow.....	C-5701
				Oil Filter Full Flow.....	C-5605
<b>WA470-6</b> (LOADERS) KOMATSU SAA6D125E-5D		<b>WA450-6-W1</b> (LOADERS) KOMATSU SAA6D125E-5		<b>WA500-1</b> (LOADERS) S6D140-1/10001	
Fuel/Water Separator.....	SFC-56020B	Fuel/Water Separator.....	SFC-56020B	Air Filter Secondary.....	A-5610
Fuel/Water Separator.....	SFC-56020	Fuel/Water Separator.....	SFC-56020	Air Filter Primary.....	A-5614
				Cabin Air Filter.....	CA-56100
				Fuel Filter.....	FC-5703
				Fuel/Water Separator.....	SFC-5707
				Hydraulic Oil Filter.....	H-5609
				Hydraulic Oil Filter.....	H-5652
				Oil Filter Full Flow.....	C-5715
				Oil Filter Full Flow.....	C-5701
				Oil Filter Full Flow.....	C-5605

MODEL/APPLICATION	SAKURA NO	MODEL/APPLICATION	SAKURA NO	MODEL/APPLICATION	SAKURA NO
<b>KOMATSU</b>		<b>KOMATSU</b>		<b>KOMATSU</b>	
<b>WA500-1</b> (LOADERS) S6D140-1A/10001 - 19999 Air Filter Secondary..... A-5610 Air Filter Primary..... A-5614 Fuel Filter..... FC-5703 Fuel/Water Separator..... SFC-5707 Hydraulic Oil Filter..... H-5652 Hydraulic Oil Filter..... H-5618 Hydraulic Oil Filter..... H-5609 Oil Filter Full Flow..... C-5605 Oil Filter Full Flow..... C-5701 Oil Filter Full Flow..... C-5715		<b>WA500-1LE</b> (LOADERS) S/N: A61001 Fuel/Water Separator..... SFC-5709-10 Fuel/Water Separator..... SFC-5705 Hydraulic Oil Filter..... H-5609 Hydraulic Oil Filter..... H-5618 Oil Filter Combination..... C-5723  <b>WA500-3</b> (LOADERS) CUMMINS N14 Fuel/Water Separator..... SFC-5709-10  <b>WA500-3</b> (LOADERS) KOMATSU SAD140E Hydraulic Oil Filter..... H-56740  <b>WA500-3</b> (LOADERS) KOMATSU S6D140E-3E Fuel/Water Separator..... SFC-56020B Fuel/Water Separator..... SFC-56020  <b>WA500-3</b> (LOADERS) M11 Cabin Air Filter..... CA-56100 Coolant Filter..... WC-5708 Fuel/Water Separator..... SFC-5709-10 Fuel/Water Separator..... SFC-5705 Oil Filter Combination..... C-5723  <b>WA500-3</b> (LOADERS) N14 Fuel/Water Separator..... SFC-5709-10 Oil Filter By Pass..... C-5718 Oil Filter Full Flow..... C-5701 Oil Filter Full Flow..... C-5715 Oil Filter Combination..... C-5723 Oil Filter Full Flow..... C-5605  <b>WA500-3</b> (LOADERS) Air Filter Secondary..... A-8580 Air Filter Secondary..... A-5610 Air Filter Primary..... A-8665M Air Filter Primary..... A-5614 Cabin Air Filter..... CA-56100 Fuel Filter..... FC-5703 Fuel/Water Separator Secondary.. SFC-5611-10 Fuel/Water Separator Secondary.. SFC-5611-10B Fuel/Water Separator..... SFC-5707 Hydraulic Oil Filter..... H-5618 Hydraulic Oil Filter..... H-2709 Oil Filter Full Flow..... C-5715 Oil Filter Full Flow..... C-5605 Oil Filter Full Flow..... C-5701  <b>WA500-3</b> (LOADERS) S6D140-1 Air Filter Secondary..... A-5610 Air Filter Primary..... A-5614 Coolant Filter..... WC-5711 Fuel/Water Separator Secondary.. SFC-1905-10 Fuel/Water Separator..... SFC-5709-10 Fuel/Water Separator..... SFC-5705 Hydraulic Oil Filter..... H-5652		Hydraulic Oil Filter..... H-2709 Hydraulic Oil Filter..... H-5618 Oil Filter Combination..... C-5723  <b>WA500-3</b> (LOADERS) S6D140E Air Filter Primary..... A-5614 Air Filter Secondary..... A-5610 Fuel Filter..... FC-5703 Fuel/Water Separator..... SFC-5707 Hydraulic Oil Filter..... H-5618 Hydraulic Oil Filter..... H-2709 Oil Filter Full Flow..... C-5715 Oil Filter Full Flow..... C-5605 Oil Filter Full Flow..... C-5701  <b>WA500-3</b> (LOADERS) w/Cummins M11 Eng. Cabin Air Filter..... CA-56100  <b>WA500-3LE</b> (LOADERS) A70001 Hydraulic Oil Filter..... H-56770  <b>WA500-3LE</b> (LOADERS) S/N: A70001 Cabin Air Filter..... CA-56100 Coolant Filter..... WC-5711 Fuel/Water Separator..... SFC-5705 Fuel/Water Separator..... SFC-5709-10 Hydraulic Oil Filter..... H-5609 Hydraulic Oil Filter..... H-5618 Oil Filter Combination..... C-5723  <b>WA500-HLLG</b> (LOADERS) SAA6D140E , 2006 Air Filter Secondary..... A-8580 Air Filter Primary..... A-8665M Cabin Air Filter..... CA-5676 Fuel/Water Separator Secondary.. SFC-5611-10 Fuel/Water Separator Secondary.. SFC-5611-10B  <b>WA500-6</b> (LOADERS) SAA6D140E , 2006 Air Filter Secondary..... A-8580 Air Filter Primary..... A-8665M Cabin Air Filter..... CA-5676 Fuel/Water Separator Secondary.. SFC-5611-10 Fuel/Water Separator Secondary.. SFC-5611-10B  <b>WA500-7</b> (LOADERS) SAA6D140E-6 , 2012 Air Filter Secondary..... A-8580 Air Filter Primary..... A-8665M Hydraulic Oil Filter..... H-5652  <b>WA50-3</b> (LOADERS) S3D84E Air Filter Primary..... AS-2205 Fuel Filter..... F-5210  <b>WA500-3A</b> (LOADERS) w/SA6D140E-3 Eng. Cabin Air Filter..... CA-56100  <b>WA50-1</b> (LOADERS) 4D955-1D	
<b>WA500-1</b> (LOADERS) S6D140-1R/10001 - 19999 Air Filter Primary..... A-5614 Air Filter Secondary..... A-5610 Fuel Filter..... FC-5703 Fuel/Water Separator..... SFC-5707 Hydraulic Oil Filter..... H-5652 Hydraulic Oil Filter..... H-5618 Hydraulic Oil Filter..... H-5609 Oil Filter Full Flow..... C-5715 Oil Filter Full Flow..... C-5701 Oil Filter Full Flow..... C-5605		<b>WA500-1</b> (LOADERS) S6D140-1A/20001 Air Filter Secondary..... A-5610 Air Filter Primary..... A-5614 Fuel Filter..... FC-5703 Fuel/Water Separator..... SFC-5707 Hydraulic Oil Filter..... H-5618 Hydraulic Oil Filter..... H-5652 Hydraulic Oil Filter..... H-5609 Oil Filter Full Flow..... C-5605 Oil Filter Full Flow..... C-5715 Oil Filter Full Flow..... C-5701		<b>WA500-1</b> (LOADERS) S6D140-1R/20001 Air Filter Secondary..... A-5610 Air Filter Primary..... A-5614 Fuel Filter..... FC-5703 Fuel/Water Separator..... SFC-5707 Hydraulic Oil Filter..... H-5652 Hydraulic Oil Filter..... H-5609 Oil Filter Full Flow..... C-5605 Oil Filter Full Flow..... C-5715 Oil Filter Full Flow..... C-5701	
<b>WA500-1LC</b> (LOADERS) A60001 Air Filter Secondary..... A-5610 Air Filter Primary..... A-5614 Cabin Air Filter..... CA-56100 Hydraulic Oil Filter..... H-5609 Hydraulic Oil Filter..... H-5652 Hydraulic Oil Filter..... H-5618 Oil Filter By Pass..... C-5718 Oil Filter Full Flow..... C-5715					

MODEL/APPLICATION	SAKURA NO	MODEL/APPLICATION	SAKURA NO	MODEL/APPLICATION	SAKURA NO
<b>KOMATSU</b>		<b>KOMATSU</b>		<b>KOMATSU</b>	
<b>WA50-1</b> (LOADERS) 4D955-1D		Hydraulic Oil Filter.....	H-5609	Air Filter Secondary.....	A-5610
Oil Filter Full Flow.....	C-5615	Oil Filter Full Flow.....	C-5715	Coolant Filter.....	WC-5705
Oil Filter Full Flow.....	C-5616	Oil Filter Full Flow.....	C-5701	Fuel/Water Separator.....	SFC-5709-10
		Oil Filter Full Flow.....	C-5605	Hydraulic Oil Filter.....	H-85680
<b>WA600</b> (LOADERS) CUMMINS QSK19				Hydraulic Oil Filter.....	H-5618
Fuel/Water Separator.....	SFC-5709-10	<b>WA600-1</b> (LOADERS) S6D170-1/10490		Oil Filter Combination.....	C-5723
		Air Filter Secondary.....	A-5610		
<b>WA600</b> (LOADERS) KOMATSU SA6D170E-2		Air Filter Primary.....	A-5614	<b>WA600-3</b> (LOADERS) S6D170E	
Hydraulic Oil Filter.....	H-56770	Coolant Filter.....	WC-6901	Air Filter Secondary.....	A-5610
		Fuel Filter.....	FC-5602	Air Filter Primary.....	A-5614
<b>WA600</b> (LOADERS) QSK19		Hydraulic Oil Filter.....	H-5618	Coolant Filter.....	WC-56010
Fuel/Water Separator.....	SFC-5709-10	Hydraulic Oil Filter.....	H-5652	Fuel Filter.....	FC-5606
Oil Filter Combination.....	C-5723	Hydraulic Oil Filter.....	H-5609	Fuel Filter.....	FC-5602
		Oil Filter Full Flow.....	C-5715	Hydraulic Oil Filter.....	H-85680
		Oil Filter Full Flow.....	C-5701	Hydraulic Oil Filter.....	H-5618
		Oil Filter Full Flow.....	C-5605	Oil Filter Full Flow.....	C-5605
<b>WA600</b> (LOADERS) SA6D170E				Oil Filter Full Flow.....	C-5701
Cabin Air Filter.....	CA-56100	<b>WA600-1</b> (LOADERS) w/Cummins Eng		Oil Filter Full Flow.....	C-5715
Fuel Filter.....	FC-5602	Cabin Air Filter.....	CA-56100		
Hydraulic Oil Filter.....	H-5609			<b>WA600-3</b> (LOADERS) S6D170E-2C/50001	
Oil Filter Full Flow.....	C-5605	<b>WA600-1</b> (LOADERS) w/S6D170-1 Eng.		Air Filter Secondary.....	A-5610
Oil Filter Full Flow.....	C-5701	Cabin Air Filter.....	CA-56100	Air Filter Primary.....	A-5614
Oil Filter Full Flow.....	C-5715			Coolant Filter.....	WC-56010
		<b>WA600-1LC</b> (LOADERS)		Fuel Filter.....	FC-5602
<b>WA600-1</b> (LOADERS) KOMATSU S6D170-1 10001		Air Filter Secondary.....	A-5610	Hydraulic Oil Filter.....	H-5618
Hydraulic Oil Filter.....	H-56770	Air Filter Primary.....	A-5614	Hydraulic Oil Filter.....	H-5652
		Cabin Air Filter.....	CA-56100	Hydraulic Oil Filter.....	H-85680
<b>WA600-1</b> (LOADERS) QSK19		Fuel/Water Separator Secondary...	SFC-1905-10	Oil Filter Full Flow.....	C-5701
Air Filter Primary.....	A-7912	Fuel/Water Separator.....	SFC-5709-10	Oil Filter Full Flow.....	C-5715
Air Filter Set.....	A-7912-S	Fuel/Water Separator.....	SFC-5705	Oil Filter Full Flow.....	C-5605
Air Filter Secondary.....	A-7915	Hydraulic Oil Filter.....	H-5618		
Fuel/Water Separator.....	SFC-5709-10	Hydraulic Oil Filter.....	H-5652	<b>WA6003A</b> (LOADERS)	
Fuel/Water Separator.....	SFC-5705	Hydraulic Oil Filter.....	H-56770	Air Filter Primary.....	A-5614
Hydraulic Oil Filter.....	H-5618	Hydraulic Oil Filter.....	H-5609	Coolant Filter.....	WC-56010
Hydraulic Oil Filter.....	H-5609	Oil Filter Full Flow.....	C-5715	Fuel Filter.....	FC-5602
Oil Filter Combination.....	C-5723	Oil Filter By Pass.....	C-5718	Hydraulic Oil Filter.....	H-85680
				Hydraulic Oil Filter.....	H-5652
<b>WA600-1</b> (LOADERS) S6D170-1		<b>WA600-1LE</b> (LOADERS) A51001		Oil Filter Full Flow.....	C-5701
Fuel Filter.....	FC-5606	Air Filter Secondary.....	A-7915	Oil Filter Full Flow.....	C-5715
		Fuel/Water Separator.....	SFC-5709-10	Oil Filter Full Flow.....	C-5605
<b>WA600-1</b> (LOADERS) S6D170-1/10001		Fuel/Water Separator.....	SFC-5705		
Air Filter Secondary.....	A-5610	Hydraulic Oil Filter.....	H-5609	<b>WA6003A</b> (LOADERS) w/SA6D170E-2, SAA6D170E-3 Engs.	
Air Filter Primary.....	A-5614	Hydraulic Oil Filter.....	H-5652	Cabin Air Filter.....	CA-56100
Cabin Air Filter.....	CA-56100	Oil Filter Combination.....	C-5723		
Fuel Filter.....	FC-5602			<b>WA600-3L</b> (LOADERS) CUMMINS QSK19-A52001	
Fuel Filter.....	FC-5621	<b>WA600-3</b> (LOADERS) CUMMINS QSK19C		Fuel/Water Separator.....	SFC-5709-10
Hydraulic Oil Filter.....	H-5652	Fuel/Water Separator.....	SFC-5709-10		
Oil Filter Full Flow.....	C-5701			<b>WA600-3L</b> (LOADERS) QSK19/A52001	
Oil Filter Full Flow.....	C-5605	<b>WA600-3</b> (LOADERS) KOMATSU S6D170-1		Fuel/Water Separator.....	SFC-5709-10
Oil Filter Full Flow.....	C-5715	Fuel/Water Separator.....	SFC-5709-10	Hydraulic Oil Filter.....	H-85680
				Hydraulic Oil Filter.....	H-5618
<b>WA600-1</b> (LOADERS) S6D170-1D/10001		<b>WA600-3</b> (LOADERS) QSK19C		Oil Filter Combination.....	C-5723
Air Filter Secondary.....	A-5610	Fuel/Water Separator.....	SFC-5709-10		
Air Filter Primary.....	A-5614			<b>WA600-3L</b> (LOADERS) S/N: A52001	
Coolant Filter.....	WC-56010	<b>WA600-3</b> (LOADERS) S6D170-1		Air Filter Secondary.....	A-5610
Fuel Filter.....	FC-5602	Air Filter Primary.....	A-5614	Air Filter Primary.....	A-5614
Hydraulic Oil Filter.....	H-5618			Cabin Air Filter.....	CA-56100
Hydraulic Oil Filter.....	H-5652			Fuel/Water Separator.....	SFC-5709-10

MODEL/APPLICATION	SAKURA NO	MODEL/APPLICATION	SAKURA NO	MODEL/APPLICATION	SAKURA NO
<b>KOMATSU</b>		<b>KOMATSU</b>		<b>KOMATSU</b>	
<b>WA600-3L</b> (LOADERS) S/N: A52001		Fuel Filter.....	FC-5602	Air Filter.....	A-5677
Hydraulic Oil Filter.....	H-5652	Hydraulic Oil Filter.....	H-5618	Air Filter Primary.....	AS-5620
Hydraulic Oil Filter.....	H-5609	Hydraulic Oil Filter.....	H-5652	Air Filter Secondary.....	A-5621
Oil Filter Combination.....	C-5723	Hydraulic Oil Filter.....	H-5609	Fuel Filter.....	FC-5604
<b>WA600-6</b> (LOADERS) SAA6D170E-5/TIER3		Oil Filter Full Flow.....	C-5701	Hydraulic Oil Filter.....	H-5652
Air Filter Secondary.....	A-8580	Oil Filter Full Flow.....	C-5715	Hydraulic Oil Filter.....	H-5618
Air Filter Primary.....	A-8665M	Oil Filter Full Flow.....	C-5605	Oil Filter Full Flow.....	C-5505
Cabin Air Filter.....	CA-5676	<b>WA700-1</b> (LOADERS) SAGD170-1/13144		Oil Filter Full Flow.....	C-5604
Coolant Filter.....	WC-56010	Air Filter Primary.....	A-5614	<b>WA75</b> (LOADERS) 2004	
Fuel/Water Separator Secondary..	SFC-5611-10B	Air Filter Secondary.....	A-5610	Air Filter Secondary.....	A-7004
Fuel/Water Separator Secondary...	SFC-5611-10	Coolant Filter.....	WC-6901	Air Filter Primary.....	A-7003
Hydraulic Oil Filter.....	H-5652	Fuel Filter.....	FC-5602	Fuel Filter.....	FC-1016
Hydraulic Oil Filter.....	H-5618	Hydraulic Oil Filter.....	H-5618	Oil Filter Full Flow.....	C-1011
<b>WA65</b> (LOADERS) 2004		Hydraulic Oil Filter.....	H-5652	<b>WA75-3</b> (LOADERS) HA950051	
Air Filter Secondary.....	A-7004	Hydraulic Oil Filter.....	H-5609	Air Filter Secondary.....	A-7004
Air Filter Primary.....	A-7003	Oil Filter Full Flow.....	C-5605	Air Filter Primary.....	A-7003
Fuel Filter.....	FC-1016	Oil Filter Full Flow.....	C-5715	Fuel Filter.....	FC-1016
Oil Filter Full Flow.....	C-1011	Oil Filter Full Flow.....	C-5701	Oil Filter Full Flow.....	C-1011
<b>WA65-3</b> (LOADERS) 4D94E		<b>WA700-1</b> (LOADERS) SAGD170-A-1Q/10001		<b>WA800-1</b> (LOADERS) SA8V170-1C/10001	
Air Filter Primary.....	A-7003	Air Filter Secondary.....	A-5610	Air Filter Primary.....	A-5614
Air Filter Secondary.....	A-7004	Air Filter Primary.....	A-5614	Air Filter Secondary.....	A-5610
Fuel Filter.....	FC-1016	Coolant Filter.....	WC-56010	Coolant Filter.....	WC-56010
<b>WA65-3</b> (LOADERS) KOMATSU 4D94E		Fuel Filter.....	FC-5602	Fuel Filter.....	FC-5703
Fuel/Water Separator.....	SF-52150	Hydraulic Oil Filter.....	H-5618	Fuel/Water Separator.....	SFC-5707
<b>WA65-5</b> (LOADERS) 4D95-LE3 , 2005		Hydraulic Oil Filter.....	H-5652	Hydraulic Oil Filter.....	H-5618
Air Filter Secondary.....	A-7004	Hydraulic Oil Filter.....	H-5609	Hydraulic Oil Filter.....	H-5652
Air Filter Primary.....	A-7003	Oil Filter Full Flow.....	C-5715	Hydraulic Oil Filter.....	H-5609
Oil Filter Full Flow.....	C-56191	Oil Filter Full Flow.....	C-5605	Hydraulic Oil Filter.....	H-5618
Oil Filter Full Flow.....	C-56190	Oil Filter Full Flow.....	C-5701	Oil Filter Full Flow.....	C-5715
<b>WA65-6</b> (LOADERS) 4D95-LE5 , 2008		<b>WA700-3</b> (LOADERS) 2007		Oil Filter Full Flow.....	C-5701
Air Filter Secondary.....	A-7004	Air Filter Secondary.....	A-8580	Oil Filter Full Flow.....	C-5605
Oil Filter Full Flow.....	C-56191	Air Filter Primary.....	A-8665M	<b>WA800-1</b> (LOADERS) SA8V170-1/10040	
Oil Filter Full Flow.....	C-56190	Coolant Filter.....	WC-6901	Air Filter Primary.....	A-5614
<b>WA700-1</b> (LOADERS) SAGD170		Fuel Filter.....	FC-5703	Air Filter Secondary.....	A-5610
Air Filter Secondary.....	A-5610	Fuel/Water Separator.....	SFC-5707	Coolant Filter.....	WC-6901
Air Filter Primary.....	A-5614	Hydraulic Oil Filter.....	H-5618	Fuel Filter.....	FC-5703
Coolant Filter.....	WC-56010	Hydraulic Oil Filter.....	H-2709	Fuel/Water Separator.....	SFC-5707
Fuel Filter.....	FC-5606	Oil Filter Full Flow.....	C-5605	Hydraulic Oil Filter.....	H-5652
Fuel Filter.....	FC-5602	Oil Filter Full Flow.....	C-5715	Hydraulic Oil Filter.....	H-5609
Hydraulic Oil Filter.....	H-5618	Oil Filter Full Flow.....	C-5701	Hydraulic Oil Filter.....	H-5618
Hydraulic Oil Filter.....	H-5609	<b>WA700-3</b> (LOADERS) SAAD170E		Oil Filter Full Flow.....	C-5605
Oil Filter Full Flow.....	C-5715	Fuel Filter.....	FC-5602	Oil Filter Full Flow.....	C-5701
Oil Filter Full Flow.....	C-5701	Fuel Filter.....	FC-5606	Oil Filter Full Flow.....	C-5715
Oil Filter Full Flow.....	C-5605	Oil Filter Full Flow.....	C-5701	<b>WA800-2</b> (LOADERS) SA12V140-1/10002/10394	
<b>WA700-1</b> (LOADERS) SAGD170-1/10001		Oil Filter By Pass.....	C-5718	Air Filter Secondary.....	A-5610
Air Filter Primary.....	A-5614	Oil Filter Full Flow.....	C-5605	Air Filter Primary.....	A-5614
Air Filter Secondary.....	A-5610	Oil Filter Full Flow.....	C-5715	Coolant Filter.....	WC-6901
Coolant Filter.....	WC-6901	<b>WA70-1</b> (LOADERS) 4D95L		Fuel Filter.....	FC-5703
<b>WA700-1</b> (LOADERS) SAGD170-1/10001		Oil Filter Full Flow.....	C-5615	Fuel/Water Separator.....	SFC-5707
Air Filter Primary.....	A-5614	Oil Filter Full Flow.....	C-5616	Hydraulic Oil Filter.....	H-5652
Air Filter Secondary.....	A-5610	<b>WA70-1</b> (LOADERS) 4D95L-W-1/10001		Hydraulic Oil Filter.....	H-5618
Coolant Filter.....	WC-6901	Air Filter Primary.....	AS-1014	Hydraulic Oil Filter.....	H-5609
<b>WA700-1</b> (LOADERS) SAGD170-1/10001				Oil Filter Full Flow.....	C-5701
Air Filter Primary.....	A-5614			Oil Filter Full Flow.....	C-5715
Air Filter Secondary.....	A-5610			Oil Filter Full Flow.....	C-5605
Coolant Filter.....	WC-6901				



MODEL/APPLICATION	SAKURA NO	MODEL/APPLICATION	SAKURA NO	MODEL/APPLICATION	SAKURA NO
<b>KOMATSU</b>		<b>KOMATSU</b>		<b>KOMATSU</b>	
<b>WA800-2 (LOADERS) SAI2V140-1/10394/10448</b>		Air Filter Primary.....	A-5614	<b>WA900-3 (LOADERS) SAA12V140</b>	
Air Filter Primary.....	A-5614	Coolant Filter.....	WC-56010	Air Filter Secondary.....	A-5610
Air Filter Secondary.....	A-5610	Fuel Filter.....	FC-5703	Air Filter Primary.....	A-5614
Coolant Filter.....	WC-6901	Fuel/Water Separator.....	SFC-5707	Cabin Air Filter.....	CA-56100
Fuel Filter.....	FC-5703	Hydraulic Oil Filter.....	H-5618	Coolant Filter.....	WC-56010
Fuel/Water Separator.....	SFC-5707	Hydraulic Oil Filter.....	H-85680	Fuel/Water Separator Secondary..	SFC-5611-10
Hydraulic Oil Filter.....	H-5652	Oil Filter Full Flow.....	C-5701	Fuel/Water Separator Secondary..	SFC-5611-10B
Hydraulic Oil Filter.....	H-5609	Oil Filter Full Flow.....	C-5715	Hydraulic Oil Filter.....	H-5618
Hydraulic Oil Filter.....	H-5618	<b>WA800-3 (LOADERS) SAI2V140-1R/50001</b>		<b>WA900-3 (LOADERS) w/SAI2V140 Eng.</b>	
Oil Filter By Pass.....	C-5718	Air Filter Secondary.....	A-5610	Cabin Air Filter.....	CA-56100
Oil Filter Full Flow.....	C-5605	Air Filter Primary.....	A-5614	<b>WA90-3 (LOADERS) 4D106E-1</b>	
Oil Filter Full Flow.....	C-5701	Coolant Filter.....	WC-56010	Air Filter Secondary.....	A-7004
Oil Filter Full Flow.....	C-5715	Fuel Filter.....	FC-5703	Air Filter Primary.....	A-7003
<b>WA800-2 (LOADERS) SAI2V140-1/10449</b>		Fuel/Water Separator.....	SFC-5707	<b>WA95-3 (LOADERS) S/N: H20677</b>	
Air Filter Secondary.....	A-5610	Hydraulic Oil Filter.....	H-85680	Fuel Filter.....	F-5218
Air Filter Primary.....	A-5614	Hydraulic Oil Filter.....	H-5652	Fuel Filter.....	FC-5201
Coolant Filter.....	WC-6901	Hydraulic Oil Filter.....	H-5618	Oil Filter Full Flow.....	C-1720
Fuel Filter.....	FC-5703	Oil Filter Full Flow.....	C-5701	<b>WA95-3 (LOADERS) S/N: HA980051</b>	
Fuel/Water Separator.....	SFC-5707	Oil Filter Full Flow.....	C-5715	Air Filter Primary.....	A-7003
Hydraulic Oil Filter.....	H-5609	Oil Filter Full Flow.....	C-5605	Air Filter Secondary.....	A-7004
Hydraulic Oil Filter.....	H-5652	<b>WA85-3 (LOADERS) HA960051</b>		Fuel Filter.....	FC-1016
Hydraulic Oil Filter.....	H-5618	Air Filter Primary.....	A-7003	Oil Filter Full Flow.....	C-5204
Oil Filter Full Flow.....	C-5701	Air Filter Secondary.....	A-7004	Oil Filter Full Flow.....	C-1011
Oil Filter Full Flow.....	C-5605	Fuel Filter.....	FC-1016	<b>WA900-1 (LOADERS) SAI2V140-1P/50001</b>	
Oil Filter By Pass.....	C-5718	Oil Filter Full Flow.....	C-5204	Air Filter Secondary.....	A-5610
Oil Filter Full Flow.....	C-5715	Oil Filter Full Flow.....	C-1011	Air Filter Primary.....	A-5614
<b>WA800-2 (LOADERS) SAI2V140-1A/10501</b>		<b>WA800-3EO (LOADERS) SAA12V140E-3</b>		Coolant Filter.....	WC-56010
Air Filter Secondary.....	A-5610	Cabin Air Filter.....	CA-56100	Fuel Filter.....	FC-5703
Air Filter Primary.....	A-5614	Cabin Air Filter Set.....	CA-5603-S	Fuel/Water Separator.....	SFC-5707
Coolant Filter.....	WC-56010	Cabin Air Filter Set.....	CA-5601-S	Hydraulic Oil Filter.....	H-5609
Fuel Filter.....	FC-5703	Fuel/Water Separator Secondary..	SFC-5611-10	Hydraulic Oil Filter.....	H-5618
Fuel/Water Separator.....	SFC-5707	Fuel/Water Separator Secondary..	SFC-5611-10B	Hydraulic Oil Filter.....	H-5652
Hydraulic Oil Filter.....	H-5609	Hydraulic Oil Filter.....	H-5652	Hydraulic Oil Filter.....	H-5609
Hydraulic Oil Filter.....	H-5618	<b>WA800-3EO (LOADERS) w/SAI2V140E Eng.</b>		Hydraulic Oil Filter.....	H-5618
Hydraulic Oil Filter.....	H-5609	Cabin Air Filter.....	CA-56100	Oil Filter Full Flow.....	C-5715
Oil Filter Full Flow.....	C-5605	<b>WA80-5 (LOADERS) KOMATSU , 2005</b>		Oil Filter Full Flow.....	C-5701
Oil Filter Full Flow.....	C-5715	Air Filter Primary.....	A-7003	Oil Filter Full Flow.....	C-5605
<b>WA800-2 (LOADERS) SAI2V140-1/10501</b>		Air Filter Secondary.....	A-7004	<b>WA900-1 (LOADERS) SAI2V140/50001</b>	
Air Filter Secondary.....	A-5610	Fuel Filter.....	FC-1801	Air Filter Secondary.....	A-5610
Air Filter Primary.....	A-5614	Fuel Filter.....	FC-1108	Air Filter Primary.....	A-5614
Coolant Filter.....	WC-6901	Oil Filter Full Flow.....	C-56191	Coolant Filter.....	WC-56010
Fuel Filter.....	FC-5703	Oil Filter Full Flow.....	C-56190	Fuel Filter.....	FC-5703
Fuel/Water Separator.....	SFC-5707	<b>WA80-3 (LOADERS) w/S4D95LE Eng.</b>		Fuel/Water Separator.....	SFC-5707
Hydraulic Oil Filter.....	H-5652	Cabin Air Filter.....	CA-56100	Hydraulic Oil Filter.....	H-5609
Hydraulic Oil Filter.....	H-5618	<b>WA90 (LOADERS)</b>		Hydraulic Oil Filter.....	H-5618
Hydraulic Oil Filter.....	H-5609	Air Filter Primary.....	A-7003	Hydraulic Oil Filter.....	H-5652
Oil Filter Full Flow.....	C-5605	Fuel Filter.....	FC-1016	Oil Filter Full Flow.....	C-5701
Oil Filter Full Flow.....	C-5701	Oil Filter Full Flow.....	C-5204	Oil Filter Full Flow.....	C-5715
Oil Filter By Pass.....	C-5718	<b>WA900-3EO (LOADERS) SAA12V140E-3</b>		Oil Filter Full Flow.....	C-5605
Oil Filter Full Flow.....	C-5715	Cabin Air Filter Set.....	CA-5603-S	<b>WA900-3EO (LOADERS) SAA12V140E-3</b>	
<b>WA800-3 (LOADERS) SAI2V140</b>				Cabin Air Filter Set.....	CA-5603-S
Air Filter Secondary.....	A-5610				

MODEL/APPLICATION	SAKURA NO	MODEL/APPLICATION	SAKURA NO	MODEL/APPLICATION	SAKURA NO
<b>KOMATSU</b>		<b>KOMATSU</b>		<b>KOMATSU</b>	
WA900-3EO (LOADERS) SAA12V140E-3 Cabin Air Filter..... CA-56100 Cabin Air Filter Set..... CA-5601-S Fuel/Water Separator Secondary.. SFC-5611-10 Fuel/Water Separator Secondary.. SFC-5611-10B Hydraulic Oil Filter..... H-5652 Hydraulic Oil Filter..... H-85680		Fuel/Water Separator..... SF-52150  WB150-2 (BACKHOE LOADERS) S4D106 Air Filter Secondary..... A-5540 Fuel Filter..... FC-1016 Oil Filter Full Flow..... C-5204  WB150-2 (BACKHOE LOADERS) S/N: 150F10001 Air Filter Secondary..... A-7964 Air Filter Primary..... AS-7805 Fuel Filter..... FC-1016 Oil Filter Full Flow..... C-5204  WB150-2N (BACKHOE LOADERS) KOMATSU S4D106 Fuel/Water Separator..... SF-52150  WB150-2N (BACKHOE LOADERS) S4D106 Air Filter Secondary..... A-5540 Fuel Filter..... FC-1016 Oil Filter Full Flow..... C-5204  WB150AWS-2N (BACKHOE LOADERS) KOMATSU S4D106 Fuel/Water Separator..... SF-52150  WB150AWS-2N (BACKHOE LOADERS) S4D106 Air Filter Secondary..... A-5540 Fuel Filter..... FC-1016 Oil Filter Full Flow..... C-5204  WB150PS-2 (BACKHOE LOADERS) KOMATSU S4D106 Fuel/Water Separator..... SF-52150  WB150PS-2 (BACKHOE LOADERS) S4D106 Air Filter Secondary..... A-5540 Fuel Filter..... FC-1016 Oil Filter Full Flow..... C-5204  WB150PS-2N (BACKHOE LOADERS) KOMATSU S4D106 Fuel/Water Separator..... SF-52150  WB150PS-2N (BACKHOE LOADERS) S4D106 Air Filter Secondary..... A-5540 Fuel Filter..... FC-1016 Oil Filter Full Flow..... C-5204  WB142-5 (BACKHOE LOADERS) S4D102LE-2 Air Filter Secondary..... A-5540 Air Filter Primary..... A-5541 Hydraulic Oil Filter Transmission.. HC-45050  WB146-5 (BACKHOE LOADERS) S4D102LE-2 Air Filter Secondary..... A-5540 Air Filter Primary..... A-5541 Hydraulic Oil Filter Transmission.. HC-45050		Hydraulic Oil Filter Transmission.. HC-45050  WB146PS-5 (BACKHOE LOADERS) S4D102LE-2 Air Filter Secondary..... A-5540 Air Filter Primary..... A-5541 Hydraulic Oil Filter Transmission.. HC-45050  WB156-5 (BACKHOE LOADERS) S4D102LE-2 Air Filter Primary..... A-5541 Air Filter Secondary..... A-5540 Hydraulic Oil Filter Transmission.. HC-45050  WB156PS-5 (BACKHOE LOADERS) S4D102LE-2 Air Filter Primary..... A-5541 Air Filter Secondary..... A-5540 Hydraulic Oil Filter Transmission.. HC-45050  WB70A (BACKHOE LOADERS) 4D98E Fuel Filter..... F-5218 Fuel Filter..... FC-1016 Hydraulic Oil Filter..... HC-7906 Oil Filter Full Flow..... C-1011  WB70A-1 (BACKHOE LOADERS)  Fuel Filter..... FC-1016  WB91R-2 (BACKHOE LOADERS) 4D106-IFA Air Filter Secondary..... A-7964 Air Filter Primary..... AS-7805 Fuel Filter..... FC-1016 Oil Filter Full Flow..... C-5204  WB93-5 (BACKHOE LOADERS) F4GE-9484F Air Filter Primary..... A-5541 Air Filter Secondary..... A-5540 Fuel/Water Separator..... SFC-45030 Hydraulic Oil Filter Transmission.. HC-45050 Oil Filter Full Flow..... C-5713  WB93R-2 (BACKHOE LOADERS) YANMAR/KMTWB003C77F26223 , 2005 Air Filter Primary..... A-5541 Fuel Filter..... FC-5201 Fuel Filter..... FC-1016 Hydraulic Oil Filter Transmission.. HC-45050 Oil Filter Full Flow..... C-5204  WB93R-2 (BACKHOE LOADERS) KOMATSU S4D106-2SFA Fuel/Water Separator..... SF-52150  WB93R-2 (BACKHOE LOADERS) S4D106-1FA Air Filter Secondary..... A-5540 Air Filter Primary..... A-7964 Air Filter Secondary..... A-5541 Air Filter Primary..... A-5541 AS-7805 Fuel Filter..... FC-5201 Fuel Filter..... FC-1016 Oil Filter Full Flow..... C-5204	
WB140-2 (BACKHOE LOADERS) KOMATSU 4D106-1 Fuel/Water Separator..... SF-52150					
WB140-2 (BACKHOE LOADERS) Air Filter Secondary..... A-7964 Air Filter Primary..... AS-7805 Fuel Filter..... FC-1016 Hydraulic Oil Filter Transmission.. HC-45050 Oil Filter Full Flow..... C-5204					
WB140-2 (BACKHOE LOADERS) S4D106-2 Air Filter Primary..... A-5541 Air Filter Secondary..... A-5540 Air Filter Secondary..... A-7964 Air Filter Primary..... AS-7805 Fuel Filter..... FC-1016 Oil Filter Full Flow..... C-5204					
WB140-2 (BACKHOE LOADERS) S/N: 140F1001 Air Filter Secondary..... A-7964 Air Filter Primary..... AS-7805 Fuel Filter..... FC-1016 Oil Filter Full Flow..... C-5204					
WB140-2N (BACKHOE LOADERS) S4D106-2 Air Filter Primary..... A-5541 Air Filter Secondary..... A-5540 Fuel Filter..... FC-1016 Oil Filter Full Flow..... C-5204					
WB140-2T (BACKHOE LOADERS) S4D106-2 Air Filter Secondary..... A-5540 Air Filter Primary..... AS-7805 Air Filter Secondary..... A-7964 Air Filter Primary..... A-5541 Fuel Filter..... FC-1016 Oil Filter Full Flow..... C-5204					
WB140PS-2N (BACKHOE LOADERS) S4D106-2 Air Filter Secondary..... A-5540 Air Filter Primary..... A-5541 Fuel Filter..... FC-1016 Oil Filter Full Flow..... C-5204					
WB150-2 (BACKHOE LOADERS) KOMATSU S4D106 Fuel/Water Separator..... SF-52150					
WB150-2 (BACKHOE LOADERS) Air Filter Secondary..... A-5540 Air Filter Primary..... A-5541 Hydraulic Oil Filter Transmission.. HC-45050					
WB150-2 (BACKHOE LOADERS) S4D102LE-2 Air Filter Secondary..... A-5540 Air Filter Primary..... A-5541 Hydraulic Oil Filter Transmission.. HC-45050					
WB150-2 (BACKHOE LOADERS) Air Filter Secondary..... A-5540 Air Filter Primary..... A-5541					

# Sakura Filter

# ENGINE APPLICATION

MODEL/APPLICATION	SAKURA NO	MODEL/APPLICATION	SAKURA NO	MODEL/APPLICATION	SAKURA NO
<b>KOMATSU</b>		<b>KOMATSU</b>		<b>KOMATSU</b>	
<b>WB97R</b> (BACKHOE LOADERS)		Air Filter Primary.....	A-5541	Hydraulic Oil Filter.....	H-5609
Air Filter Secondary.....	A-7964	Air Filter Secondary.....	A-5540	Oil Filter Full Flow.....	C-5715
Fuel Filter.....	FC-1016	Fuel Filter.....	FC-5715	Oil Filter Full Flow.....	C-5605
Oil Filter Full Flow.....	C-5204	Hydraulic Oil Filter Transmission..	HC-45050	Oil Filter Full Flow.....	C-5701
<b>WB97R</b> (BACKHOE LOADERS) S/N: KMTWB015K77F50008		Oil Filter Full Flow.....	C-5713	<b>WD600-3</b> (DOZERS) w/SAAG6D170E-3 Eng.	
Air Filter Primary.....	A-5541	<b>WB93R-5E0</b> (BACKHOE LOADERS)		Cabin Air Filter.....	CA-56100
Air Filter Secondary.....	A-5540	Air Filter Primary.....	A-5541	<b>WD600</b> (DOZERS)	
Fuel Filter.....	FC-5715	Air Filter Secondary.....	A-5540	Fuel Filter.....	FC-56300
Hydraulic Oil Filter Transmission..	HC-45050	Fuel Filter.....	FC-5715	<b>WD900-3</b> (DOZERS) w/SA12V140-15 Eng.	
Oil Filter Full Flow.....	C-5713	Hydraulic Oil Filter Transmission..	HC-45050	Cabin Air Filter.....	CA-56100
<b>WB97R-5</b> (BACKHOE LOADERS) SAA4D104E , 2005		Oil Filter Full Flow.....	C-5713	<b>WF22-2</b> (MOTOR GRADERS) 1011	
Air Filter Primary.....	A-5541	<b>WB93R-5E0</b> (BACKHOE LOADERS) S4D104E-3 , 2005		Fuel Filter.....	F-5601
Air Filter Secondary.....	A-5540	Air Filter Primary.....	A-5541	Hydraulic Oil Filter.....	H-5620
Hydraulic Oil Filter Transmission..	HC-45050	Air Filter Secondary.....	A-5540	Hydraulic Oil Filter.....	H-5610
Oil Filter Full Flow.....	C-5713	Hydraulic Oil Filter Transmission..	HC-45050	Oil Filter Full Flow.....	O-5603
<b>WB97S-2</b> (BACKHOE LOADERS)		Oil Filter Full Flow.....	C-5713	Oil Filter By Pass.....	O-5704
Fuel/Water Separator.....	SF-52150	<b>WB97R-1</b> (BACKHOE LOADERS)		<b>WF22A(T)-2</b> (MOTOR GRADERS) NTC-743	
<b>WB97S-2</b> (BACKHOE LOADERS) S4D106-2		Air Filter Primary.....	AS-7805	Coolant Filter.....	WC-5707
Air Filter Secondary.....	A-5540	Air Filter Secondary.....	A-7964	Hydraulic Oil Filter.....	H-5610
Air Filter Secondary.....	A-7964	Fuel Filter.....	FC-1702	Hydraulic Oil Filter.....	H-56600
Air Filter Primary.....	A-5541	Fuel Filter.....	FC-5103	Hydraulic Oil Filter.....	H-5620
Air Filter Primary.....	AS-7805	Hydraulic Oil Filter.....	HC-7913	Oil Filter Full Flow.....	O-5603
Fuel Filter.....	FC-1016	Oil Filter Full Flow.....	C-5102	Oil Filter By Pass.....	O-5704
Oil Filter Full Flow.....	C-5204	<b>WB97R-2</b> (BACKHOE LOADERS)		<b>WF22A-2</b> (MOTOR GRADERS) NTC-743	
<b>WB93R-5</b> (BACKHOE LOADERS) S4D104E-3 , 2005		Fuel/Water Separator.....	SF-52150	Coolant Filter.....	WC-5707
Air Filter Secondary.....	A-5540	<b>WB97R-2</b> (BACKHOE LOADERS) SD106-1FA		Fuel Filter.....	F-5601
Air Filter Primary.....	A-5541	Air Filter Secondary.....	A-7964	Hydraulic Oil Filter.....	H-5620
Hydraulic Oil Filter Transmission..	HC-45050	Air Filter Primary.....	AS-7805	Hydraulic Oil Filter.....	H-5610
Oil Filter Full Flow.....	C-5713	Fuel Filter.....	FC-1016	Hydraulic Oil Filter.....	H-56600
<b>WB93S-5</b> (BACKHOE LOADERS) S4D104E-3 , 2005		Oil Filter Full Flow.....	C-5204	Oil Filter Full Flow.....	O-5603
Air Filter Secondary.....	A-5540	<b>WD500-3</b> (DOZERS)		Oil Filter By Pass.....	O-5704
Air Filter Primary.....	A-5541	Air Filter Secondary.....	A-5610	<b>WF600T-1</b> (LOADERS) S6D140-1/10001	
Hydraulic Oil Filter Transmission..	HC-45050	Air Filter Primary.....	A-5614	Air Filter Secondary.....	A-5610
Oil Filter Full Flow.....	C-5713	Oil Filter Full Flow.....	C-5701	Air Filter Primary.....	A-5614
<b>WB93S-5E0</b> (BACKHOE LOADERS) S4D104E-3 , 2005		Oil Filter Full Flow.....	C-5605	Fuel Filter.....	FC-5703
Air Filter Primary.....	A-5541	Oil Filter Full Flow.....	C-5715	Fuel/Water Separator.....	SFC-5707
Air Filter Secondary.....	A-5540	<b>WD6001</b> (DOZERS)		Hydraulic Oil Filter.....	H-5652
Hydraulic Oil Filter Transmission..	HC-45050	Fuel Filter.....	FC-5602	Hydraulic Oil Filter.....	H-5609
Oil Filter Full Flow.....	C-5713	Hydraulic Oil Filter.....	H-5618	Hydraulic Oil Filter.....	H-5618
<b>WB95R-1</b> (BACKHOE LOADERS)		Hydraulic Oil Filter.....	H-5652	Oil Filter Full Flow.....	C-5701
Air Filter Secondary.....	A-7964	Oil Filter Full Flow.....	C-5715	Oil Filter Full Flow.....	C-5605
Air Filter Primary.....	AS-7805	Oil Filter Full Flow.....	C-5701	Oil Filter Full Flow.....	C-5715
Fuel Filter.....	FC-5103	Oil Filter Full Flow.....	C-5605	<b>WH609/1</b> (HANDLER TELESCOPIC) S/N: KMTWH001C77F60093 , 2004	
Fuel Filter.....	FC-1702	<b>WD600-3</b> (DOZERS) 2006		Fuel Filter.....	FC-5715
Hydraulic Oil Filter.....	HC-7913	Air Filter Secondary.....	A-8580	Fuel/Water Separator.....	SFC-45030
Oil Filter Full Flow.....	C-5102	Air Filter Primary.....	A-8665M	Oil Filter Full Flow.....	C-5713
<b>WB97S-5E0</b> (BACKHOE LOADERS)		Cabin Air Filter.....	CA-5676	<b>WH613</b> (HANDLER TELESCOPIC) KOMATSU , 2004	
Air Filter Secondary.....	A-7964	Coolant Filter.....	WC-56010	Fuel Filter.....	FC-5715
Air Filter Primary.....	AS-7805	Hydraulic Oil Filter.....	H-5618		

# Sakura Filter

# ENGINE APPLICATION

MODEL/APPLICATION	SAKURA NO	MODEL/APPLICATION	SAKURA NO	MODEL/APPLICATION	SAKURA NO
<b>KOMATSU</b>		<b>KOMATSU</b>		<b>KOMATSU</b>	
<b>WH613</b> (HANDLER TELESCOPIC) KOMATSU , 2004		<b>WS16S-3</b> (SCRAPERS) 3001		<b>WX D65</b> (DOZERS) KOMATSU SAA6D114E , 2011	
Oil Filter Full Flow.....	C-5713	Air Filter Secondary.....	A-5610	Fuel Filter.....	FC-5610
<b>WH713</b> (HANDLER TELESCOPIC) 2004		Air Filter Primary.....	A-5614	<b>XT430L-2</b> (FELLER BUNCHERS) QSC8.3/TIER3	
Fuel Filter.....	FC-5715	Fuel Filter.....	FC-5703	Fuel Filter.....	FC-5521
Oil Filter Full Flow.....	C-5713	Fuel/Water Separator.....	SFC-5707	Fuel/Water Separator.....	SFC-5509-10
<b>WH714</b> (HANDLER TELESCOPIC) KOMATSU , 2004		Hydraulic Oil Filter.....	H-5610		
Fuel Filter.....	FC-5715	Hydraulic Oil Filter.....	H-5609		
Oil Filter Full Flow.....	C-5713	Oil Filter Full Flow.....	C-5701		
<b>WH714H</b> (HANDLER TELESCOPIC) KOMATSU , 2004		Oil Filter Full Flow.....	C-5605		
Fuel Filter.....	FC-5715	Oil Filter Full Flow.....	C-5715		
Oil Filter Full Flow.....	C-5713	Oil Filter By Pass.....	O-5704		
<b>WH716</b> (HANDLER TELESCOPIC) KOMATSU , 2004		<b>WS23-1</b> (SCRAPERS) NTA-855			
Fuel Filter.....	FC-5715	Air Filter Secondary.....	A-5610		
Oil Filter Full Flow.....	C-5713	Air Filter Primary.....	A-5614		
<b>WR11</b> (LOADERS) 6D95L		Fuel Filter.....	FC-5602		
Fuel Filter.....	FC-5604	Hydraulic Oil Filter.....	H-56600		
Oil Filter Full Flow.....	C-5604	Hydraulic Oil Filter.....	H-5609		
Oil Filter Full Flow.....	C-5615	Hydraulic Oil Filter.....	H-5610		
Oil Filter Full Flow.....	C-5616	Oil Filter Full Flow.....	C-5605		
<b>WR8</b> (LOADERS) 4D95L		Oil Filter Full Flow.....	C-5701		
Fuel Filter.....	FC-5604	Oil Filter Full Flow.....	C-5715		
Oil Filter Full Flow.....	C-5604	Oil Filter Full Flow.....	C-5605		
Oil Filter Full Flow.....	C-5615	<b>WS23-2</b> (SCRAPERS) S/N: 2001			
Oil Filter Full Flow.....	C-5616	Air Filter Secondary.....	A-5610		
<b>WS16S-1</b> (SCRAPERS) NTA-855		Air Filter Primary.....	A-5614		
Air Filter Primary.....	A-5614	Fuel Filter.....	FC-5703		
Air Filter Secondary.....	A-5610	Fuel/Water Separator.....	SFC-5707		
Coolant Filter.....	WC-5707	Hydraulic Oil Filter.....	H-5610		
Fuel Filter.....	FC-5602	Hydraulic Oil Filter.....	H-5609		
Hydraulic Oil Filter.....	H-56600	Oil Filter Full Flow.....	C-5701		
Hydraulic Oil Filter.....	H-5609	Oil Filter Full Flow.....	C-5715		
Hydraulic Oil Filter.....	H-5610	Oil Filter Full Flow.....	C-5605		
Oil Filter Full Flow.....	C-5701	<b>WS23S-1</b> (SCRAPERS) KT-1150			
Oil Filter Full Flow.....	C-5715	Air Filter Secondary.....	A-5610		
Oil Filter Full Flow.....	C-5605	Air Filter Primary.....	A-5614		
<b>WS16S-2</b> (SCRAPERS) NTA-855		Coolant Filter.....	WC-5705		
Air Filter Secondary.....	A-5610	Fuel Filter.....	FC-5721		
Air Filter Primary.....	A-5614	Fuel Filter.....	FC-5702		
Coolant Filter.....	WC-5707	Hydraulic Oil Filter.....	H-5610		
Fuel Filter.....	FC-5602	Hydraulic Oil Filter.....	H-56600		
Hydraulic Oil Filter.....	H-56600	Hydraulic Oil Filter.....	H-5609		
Hydraulic Oil Filter.....	H-5609	Oil Filter Full Flow.....	C-5715		
Hydraulic Oil Filter.....	H-5610	Oil Filter By Pass.....	O-5704		
Oil Filter By Pass.....	O-5704	<b>WS23S-2</b> (SCRAPERS) S6D140/3001			
Oil Filter Full Flow.....	C-5701	Air Filter Secondary.....	A-5610		
Oil Filter Full Flow.....	C-5715	Air Filter Primary.....	A-5614		
Oil Filter Full Flow.....	C-5605	Coolant Filter.....	WC-6901		
		Fuel Filter.....	FC-5703		
		Fuel/Water Separator.....	SFC-5707		
		Hydraulic Oil Filter.....	H-5609		
		Hydraulic Oil Filter.....	H-5610		
		Oil Filter Full Flow.....	C-5715		
		Oil Filter Full Flow.....	C-5701		
		Oil Filter Full Flow.....	C-5605		

**B**

**A-1004** Air Filter Metal End Cap Element



MAZDA 0259-23-603  
NISSAN 16546-08000  
TOYOTA 17801-34010  
MITSUBISHI 3649329  
ISUZU 5-14215-003-0

H 1 : 61 (mm)  
OD 1 : 250 (mm)  
OD 2 : 250 (mm)  
ID 1 : 192 (mm)  
ID 2 : 192 (mm)

CONT : 20  
VOL : 0.092

Note : metal end cap version

**A-1841-S** Air Filter Set Metal End Cap Element



NISSAN 16546-96070  
HITACHI 4288963+4288964  
KOMATSU 600-181-1600

Primary Filter uses A-1013  
Secondary Filter uses A-5631

H 1 : 395 (mm)  
H 2 : 382 (mm)  
OD 1 : 276 (mm)  
OD 2 : 276 (mm)  
ID 1 : 165 (mm)  
ID 2 : 23 (mm)

CONT : 4  
VOL : 0.163

**A-44320** Air Filter Secondary Soft PU end cap Element



CATERPILLAR 267-3005  
KOMATSU XA4291

Primary Filter uses A-44310  
Set Filter uses A-44310-S

H 1 : 570 (mm)  
OD 1 : 294 (mm)  
OD 2 : 281 (mm)  
ID 1 : 236 (mm)

CONT : 1  
VOL : 0.064

**A-1013** Air Filter Primary Metal End Cap Element



ISUZU 1-14214126-0  
ISUZU 1-14215-181-0  
ISUZU 1-86750-309-0  
NISSAN 16546-96071  
NISSAN 16546-99218

Secondary Filter uses A-5631  
Set Filter uses A-1841-S

H 1 : 394.7 (mm)  
H 2 : 382 (mm)  
OD 1 : 276 (mm)  
OD 2 : 275 (mm)  
ID 1 : 165 (mm)  
ID 2 : 23 (mm)

CONT : 4  
VOL : 0.154

Note : Is a Primary Air Filter for A-5631,A-7607

**A-2210** Air Filter Primary Metal End Cap Element



FIAT 0068473-3  
ISUZU 1-14215-018-0  
ISUZU 1-14215007-0  
NISSAN 16546-96011

Secondary Filter uses A-6008  
Set Filter uses A-6117-S

H 1 : 342.7 (mm)  
H 2 : 330 (mm)  
OD 1 : 234 (mm)  
OD 2 : 234 (mm)  
ID 1 : 123 (mm)  
ID 2 : 17 (mm)

CONT : 4  
VOL : 0.093

**A-5105** Air Filter Primary Soft PU end cap Element



BOMAG 05821147  
VOLVO 2908237  
MASSEY-FERGUSON 3901477M1  
J.C.BAMFORD 580-12020

Secondary Filter uses A-5106  
Set Filter uses A-5107-S

H 1 : 400 (mm)  
H 2 : 367 (mm)  
OD 1 : 194 (mm)  
OD 2 : 194 (mm)  
ID 1 : 113.5 (mm)

CONT : 4  
VOL : 0.078

**A-10134** Air Filter Primary Metal End Cap Element



MITSUBISHI ME 063130

H 1 : 394.7 (mm)  
H 2 : 382 (mm)  
OD 1 : 276 (mm)  
OD 2 : 275 (mm)  
ID 1 : 165 (mm)  
ID 2 : 23 (mm)

CONT : 1  
VOL : 0.035

Note : Flame retardant version from A-1013

**A-3320** Air Filter Plastic framed Element



DAIHATSU 15601-87716  
TOYOTA 17801-03030  
TOYOTA 17801-74010  
DAIHATSU 17801-87104  
DAIHATSU 17801-87104-000

H 1 : 51 (mm)  
Length 1 : 222.5 (mm)  
Width 1 : 165 (mm)

CONT : 24  
VOL : 0.060

Note : A-1122 Soft PU Versions, A-3320 Plastic Version

**A-5106** Air Filter Secondary Soft PU end cap Element



VOLVO 2908238  
MASSEY-FERGUSON 3901478M1  
J.C.BAMFORD 580-12021

Primary Filter uses A-5105  
Set Filter uses A-5107-S

H 1 : 386 (mm)  
H 2 : 380 (mm)  
OD 1 : 104 (mm)  
OD 2 : 107 (mm)  
ID 1 : 93 (mm)

CONT : 25  
VOL : 0.178

**A-1307** Air Filter Secondary Metal End Cap Element



ISUZU 1-14215085-0  
HINO 17801-2460  
CATERPILLAR 3I-0179

Primary Filter uses A-1313  
Set Filter uses A-5662-S

H 1 : 444.7 (mm)  
H 2 : 432 (mm)  
OD 1 : 145 (mm)  
OD 2 : 145 (mm)  
ID 1 : 116.5 (mm)  
ID 2 : 23 (mm)

CONT : 9  
VOL : 0.106

**A-44310** Air Filter Primary Soft PU end cap Element



CATERPILLAR 267-3004  
CATERPILLAR 419-9162  
KOMATSU XA4292

Secondary Filter uses A-44320  
Set Filter uses A-44310-S

H 1 : 617 (mm)  
H 2 : 612 (mm)  
OD 1 : 450 (mm)  
OD 2 : 450 (mm)  
ID 1 : 292 (mm)

CONT : 1  
VOL : 0.150

**A-5114** Air Filter Secondary Metal End Cap Element



CASE 131100190019  
INTERNATIONAL HARVESTER 3  
148 080  
ATLAS COPCO 361 1276

Primary Filter uses A-6808  
Set Filter uses A-6808-S

H 1 : 284.5 (mm)  
H 2 : 266 (mm)  
OD 1 : 69.6 (mm)  
OD 2 : 60.7 (mm)  
ID 1 : 52.4 (mm)  
ID 2 : 16.8 (mm)

CONT : 25  
VOL : 0.054

**A-1313** Air Filter Primary Metal End Cap Element



CATERPILLAR 099-5801  
ISUZU 1-14215084-0  
HINO 17720-3640  
HINO 17801-2530

Secondary Filter uses A-1307  
Set Filter uses A-5662-S

H 1 : 469.75 (mm)  
H 2 : 457 (mm)  
OD 1 : 232 (mm)  
OD 2 : 232 (mm)  
ID 1 : 147 (mm)  
ID 2 : 23 (mm)

CONT : 4  
VOL : 0.123

**A-44310-S** Air Filter Set Soft PU end cap Element



CATERPILLAR 267-3004+267-3005  
KOMATSU XA4292+XA4291

Primary Filter uses A-44310  
Secondary Filter uses A-44320

H 1 : 617 (mm)  
H 2 : 612 (mm)  
OD 1 : 450 (mm)  
OD 2 : 450 (mm)  
ID 1 : 236 (mm)

CONT : 1  
VOL : 0.150

**A-5206** Air Filter Metal End Cap Element



YANMAR 114250-12580

H 1 : 45.5 (mm)  
OD 1 : 105 (mm)  
OD 2 : 100 (mm)  
ID 1 : 54.5 (mm)  
ID 2 : 6 (mm)

CONT : 50  
VOL : 0.038

**A-52180** Air Filter Metal End Cap Element With Foam Wrap

YANMAR 114650-12590  
YANMAR 114650-12591  
KOMATSU YM11465012540



H 1 : 72.5 (mm)  
OD 1 : 142 (mm)  
OD 2 : 99 (mm)  
ID 1 : 94 (mm)  
ID 2 : 50 (mm)

CONT : 20  
VOL : 0.031

**A-5408** Air Filter Secondary Metal End Cap Element

ISUZU 1-14215034-0  
ISUZU 1-14215036-0  
NISSAN 16546-96014



Primary Filter uses A-6113  
Set Filter uses A-5653-S  
H 1 : 406 (mm)  
OD 1 : 192.3 (mm)  
OD 2 : 162.5 (mm)  
ID 1 : 134.2 (mm)  
ID 2 : 17 (mm)

CONT : 9  
VOL : 0.167

Note : Is a Secondary Air filter for A-6113,A-54490

**A-5420** Air Filter Primary Metal End Cap Element

INTERNATIONAL HARVESTER  
672019 C2



Secondary Filter uses A-5421  
Set Filter uses A-5420-S  
H 1 : 342.75 (mm)  
H 2 : 330 (mm)  
OD 1 : 307 (mm)  
OD 2 : 307 (mm)  
ID 1 : 196 (mm)  
ID 2 : 17 (mm)

CONT : 1  
VOL : 0.037

**A-5309** Air Filter Secondary Metal End Cap Element

MERCEDES-BENZ 002 094 33 04  
INTERNATIONAL HARVESTER  
3147878R1  
DEUTZ 4144897



Primary Filter uses A-6201  
Set Filter uses A-6201-S  
H 1 : 326 (mm)  
H 2 : 326 (mm)  
OD 1 : 78 (mm)  
OD 2 : 68 (mm)  
ID 1 : 58 (mm)  
ID 2 : 18 (mm)

CONT : 25  
VOL : 0.104

**A-5410** Air Filter Metal End Cap Element

KOMATSU 385-10161992  
INTERNATIONAL HARVESTER  
667975 C1  
JOHN DEERE AT49022



H 1 : 518 (mm)  
OD 1 : 282 (mm)  
OD 2 : 282 (mm)  
ID 1 : 170 (mm)  
ID 2 : 17 (mm)

CONT : 1  
VOL : 0.050

**A-5420-S** Air Filter Set Metal End Cap Element

INTERNATIONAL HARVESTER  
672019C2+672020C1



Primary Filter uses A-5420  
Secondary Filter uses A-5421  
H 1 : 331 (mm)  
H 2 : 305 (mm)  
OD 1 : 307 (mm)  
OD 2 : 194 (mm)  
ID 1 : 196 (mm)  
ID 2 : 17 (mm)

CONT : 1  
VOL : 0.041

**A-5405** Air Filter Primary Metal End Cap Element

HITACHI 4230365  
INTERNATIONAL HARVESTER  
627127 C1  
JOHN DEERE AE30508



Secondary Filter uses A-5406  
Set Filter uses A-5405-S  
H 1 : 418 (mm)  
H 2 : 405.5 (mm)  
OD 1 : 264.5 (mm)  
OD 2 : 264.5 (mm)  
ID 1 : 153 (mm)  
ID 2 : 23 (mm)

CONT : 1  
VOL : 0.033

**A-5413** Air Filter Primary Metal End Cap Element

KOMATSU 044-38510-56931  
KOMATSU 385-102-56931  
CATERPILLAR 3I-0260



Secondary Filter uses A-5414  
Set Filter uses A-5660-S  
H 1 : 317.7 (mm)  
H 2 : 305 (mm)  
OD 1 : 264.5 (mm)  
OD 2 : 264.5 (mm)  
ID 1 : 153 (mm)  
ID 2 : 17 (mm)

CONT : 1  
VOL : 0.027

**A-5425** Air Filter Primary Metal End Cap Element

HINO 17801-2020  
HINO 17801-2270  
HINO 17801-2290



Secondary Filter uses A-5417  
Set Filter uses A-5425-S  
H 1 : 418.7 (mm)  
H 2 : 406 (mm)  
OD 1 : 307 (mm)  
OD 2 : 307 (mm)  
ID 1 : 196 (mm)  
ID 2 : 22.7 (mm)

CONT : 1  
VOL : 0.050

**A-5405-S** Air Filter Set Metal End Cap Element

HITACHI 4230365+4230364  
INTERNATIONAL HARVESTER  
627127C1+627128C1



Primary Filter uses A-5405  
Secondary Filter uses A-5406  
H 1 : 418 (mm)  
H 2 : 405.5 (mm)  
OD 1 : 264.5 (mm)  
OD 2 : 264.5 (mm)  
ID 1 : 153 (mm)  
ID 2 : 23 (mm)

CONT : 1  
VOL : 0.036

**A-5414** Air Filter Secondary Metal End Cap Element

KOMATSU 044-38510-56941  
CATERPILLAR 3I-0254  
INTERNATIONAL HARVESTER  
627935 C1



Primary Filter uses A-5413  
Set Filter uses A-5660-S  
H 1 : 266.75 (mm)  
H 2 : 254 (mm)  
OD 1 : 151 (mm)  
OD 2 : 151 (mm)  
ID 1 : 123 (mm)  
ID 2 : 17 (mm)

CONT : 9  
VOL : 0.094

**A-5434** Air Filter Metal End Cap Element

KOMATSU 381-935694-1  
INTERNATIONAL HARVESTER  
935694 C1



H 1 : 419.2 (mm)  
H 2 : 406.5 (mm)  
OD 1 : 264.5 (mm)  
OD 2 : 264.5 (mm)  
ID 1 : 153 (mm)  
ID 2 : 17 (mm)

CONT : 1  
VOL : 0.033

**A-5406** Air Filter Secondary Metal End Cap Element

KOMATSU 381-935-6931  
HITACHI 4230364  
INTERNATIONAL HARVESTER  
627128 C1



Primary Filter uses A-5405  
Set Filter uses A-5405-S  
H 1 : 367.7 (mm)  
H 2 : 355 (mm)  
OD 1 : 151 (mm)  
OD 2 : 151 (mm)  
ID 1 : 123 (mm)  
ID 2 : 23 (mm)

CONT : 9  
VOL : 0.100

**A-5417** Air Filter Secondary Metal End Cap Element

NISSAN 16546-90204  
INTERNATIONAL HARVESTER  
702753 C1



Primary Filter uses A-5425  
Set Filter uses A-5425-S  
H 1 : 393.7 (mm)  
H 2 : 381 (mm)  
OD 1 : 194 (mm)  
OD 2 : 194 (mm)  
ID 1 : 153 (mm)  
ID 2 : 22.7 (mm)

CONT : 9  
VOL : 0.169

**A-5437** Air Filter Secondary Metal End Cap Element

CASE 1129112-C1  
FURUKAWA 1129112C1



Primary Filter uses AS-8502  
Set Filter uses AS-8502-S  
H 1 : 365 (mm)  
H 2 : 355 (mm)  
OD 1 : 104 (mm)  
OD 2 : 104 (mm)  
ID 1 : 74 (mm)  
ID 2 : 17 (mm)

CONT : 25  
VOL : 0.141

# Sakura Filter

# Technical Specification

**A-55211** Air Filter Primary Rigid PU end cap Element

CATERPILLAR 1P-8483  
CATERPILLAR 7W-5313



Secondary Filter uses A-55291  
Set Filter uses A-55211-S  
H 1 : 395 (mm)  
H 2 : 382 (mm)  
OD 1 : 316 (mm)  
OD 2 : 316 (mm)  
ID 1 : 225 (mm)

CONT : 1  
VOL : 0.045

Note : is Rigid PU version of A-5521

**A-5558M** Air Filter Primary Soft PU+Metal Element

KOMATSU 600-185-5100P  
KOMATSU 600-185-5110  
CATERPILLAR 6I-2503



Secondary Filter uses A-5559  
Set Filter uses A-5558M-S  
H 1 : 417 (mm)  
H 2 : 405 (mm)  
OD 1 : 280 (mm)  
OD 2 : 280 (mm)  
ID 1 : 148 (mm)

CONT : 1  
VOL : 0.038

Note : with reinforcement

**A-5602** Air Filter Primary Metal End Cap Element

KOMATSU 600-181-2450  
KOMATSU 600-181-2500



Secondary Filter uses A-5603  
Set Filter uses A-5601-S  
H 1 : 332.75 (mm)  
H 2 : 320 (mm)  
OD 1 : 246.5 (mm)  
OD 2 : 246.5 (mm)  
ID 1 : 143.3 (mm)  
ID 2 : 17 (mm)

CONT : 1  
VOL : 0.026

**A-55211-S** Air Filter Set rigid PU+metal Element

CATERPILLAR 7W-5313+7N-1308



Primary Filter uses A-55211  
Secondary Filter uses A-55291  
H 1 : 395 (mm)  
H 2 : 382 (mm)  
OD 1 : 316 (mm)  
OD 2 : 316 (mm)  
ID 1 : 178 (mm)

CONT : 1  
VOL : 0.047

Note : is rigid PU version of A-5521-S

**A-5558M-S** Air Filter Set Soft PU+Metal Element

KOMATSU 600-185-5100  
CATERPILLAR 6I-2503+6I-2504



Primary Filter uses A-5558M  
Secondary Filter uses A-5559  
H 1 : 417 (mm)  
H 2 : 405 (mm)  
OD 1 : 280 (mm)  
OD 2 : 280 (mm)  
ID 1 : 148 (mm)

CONT : 1  
VOL : 0.038

Note : with reinforcement

**A-5603** Air Filter Secondary Metal End Cap Element

KOMATSU 600-181-2460  
KOMATSU 600-181-2461  
KOMATSU 600-311-2460



Primary Filter uses A-5602  
Set Filter uses A-5601-S  
H 1 : 271 (mm)  
H 2 : 269 (mm)  
OD 1 : 141 (mm)  
OD 2 : 141 (mm)  
ID 1 : 107.5 (mm)  
ID 2 : 17 (mm)

CONT : 12  
VOL : 0.093

**A-55291** Air Filter Secondary Metal End Cap Element with 10 Bolt Holes

CATERPILLAR 7N-1308



Primary Filter uses A-55211  
Set Filter uses A-55211-S  
H 1 : 384 (mm)  
H 2 : 383 (mm)  
OD 1 : 289 (mm)  
OD 2 : 219.5 (mm)  
ID 1 : 178 (mm)

CONT : 1  
VOL : 0.038

**A-5559** Air Filter Secondary Soft PU end cap Element

KOMATSU 424-01-H0P02  
KOMATSU 600-185-5100S  
KOMATSU 600-185-5120



Primary Filter uses A-5558  
Set Filter uses A-5558-S  
H 1 : 394 (mm)  
OD 1 : 150 (mm)  
OD 2 : 142.3 (mm)  
ID 1 : 109 (mm)

CONT : 1  
VOL : 0.011

**A-5604-S** Air Filter Set Metal End Cap Element

KOMATSU 600-181-1260  
KOMATSU 600-182-2500  
KOMATSU 6112-83-7600



Primary Filter uses A-5605  
Secondary Filter uses A-5606  
H 1 : 380 (mm)  
H 2 : 330 (mm)  
OD 1 : 244 (mm)  
OD 2 : 129 (mm)  
ID 1 : 123 (mm)  
ID 2 : 17 (mm)

CONT : 1  
VOL : 0.030

**A-5540** Air Filter Secondary Soft PU end cap Element

YANMAR 119117-12570  
CATERPILLAR 1318903  
PERKINS 26510343  
YANMAR Y119117-12570



Primary Filter uses A-5541  
Set Filter uses A-5541-S  
H 1 : 346 (mm)  
H 2 : 340 (mm)  
OD 1 : 92 (mm)  
OD 2 : 86.5 (mm)  
ID 1 : 72.5 (mm)

CONT : 25  
VOL : 0.105

**A-5569** Air Filter Secondary Soft PU end cap Element

VOLVO 11801160  
CATERPILLAR 1467473  
LIUGONG 40C0445  
JOHN DEERE M131803  
KOMATSU YM12905112530



Primary Filter uses A-8513  
Set Filter uses A-5570-S  
H 1 : 265 (mm)  
H 2 : 259 (mm)  
OD 1 : 61 (mm)  
OD 2 : 59 (mm)  
ID 1 : 45 (mm)

CONT : 25  
VOL : 0.048

**A-5605** Air Filter Primary Metal End Cap Element

CATERPILLAR 3I-0867  
KOMATSU 600-181-1320  
KOMATSU 600-181-1340



Secondary Filter uses A-5606  
Set Filter uses A-5604-S  
H 1 : 393.7 (mm)  
H 2 : 381 (mm)  
OD 1 : 244.5 (mm)  
OD 2 : 244.5 (mm)  
ID 1 : 133.5 (mm)  
ID 2 : 17 (mm)

CONT : 1  
VOL : 0.027

**A-5541** Air Filter Primary Soft PU end cap Element

YANMAR 119117-12560  
CATERPILLAR 131-8902  
PERKINS 26510342  
LIUGONG 40C0496  
HITACHI 4486002



Secondary Filter uses A-5540  
Set Filter uses A-5541-S  
H 1 : 356 (mm)  
H 2 : 347 (mm)  
OD 1 : 163.5 (mm)  
OD 2 : 163.5 (mm)  
ID 1 : 91 (mm)

CONT : 9  
VOL : 0.108

**A-5601-S** Air Filter Set Metal End Cap Element

KOMATSU 600-181-8550  
KOMATSU 6114-80-7010  
KOMATSU 6114-80-7101



Primary Filter uses A-5602  
Secondary Filter uses A-5603  
H 1 : 320 (mm)  
H 2 : 268 (mm)  
OD 1 : 246.5 (mm)  
OD 2 : 246.5 (mm)  
ID 1 : 143 (mm)  
ID 2 : 16 (mm)

CONT : 1  
VOL : 0.026

**A-5606** Air Filter Secondary Metal End Cap Element

KOMATSU 600-181-2350  
KOMATSU 600-182-2500  
KOMATSU 6112-83-7620



Primary Filter uses A-5605  
Set Filter uses A-5604-S  
H 1 : 342.7 (mm)  
H 2 : 330 (mm)  
OD 1 : 129 (mm)  
OD 2 : 129 (mm)  
ID 1 : 97 (mm)  
ID 2 : 17 (mm)

CONT : 9  
VOL : 0.084



# Sakura Filter

# Technical Specification

**A-5608** Air Filter Primary Metal End Cap Element  
KOMATSU 600-181-7210



Secondary Filter uses A-5609  
Set Filter uses A-5608-S  
H 1 : 311.7 (mm)  
H 2 : 299 (mm)  
OD 1 : 179.5 (mm)  
OD 2 : 179.5 (mm)  
ID 1 : 101 (mm)  
ID 2 : 14 (mm)

CONT : 9  
VOL : 0.124

46

**A-5617** Air Filter Secondary Metal End Cap Element  
KOMATSU 600-181-9120  
KOMATSU 600-181-9320



Primary Filter uses A-5616  
Set Filter uses A-5655-S  
H 1 : 300.7 (mm)  
H 2 : 291 (mm)  
OD 1 : 104 (mm)  
OD 2 : 104 (mm)  
ID 1 : 74 (mm)  
ID 2 : 17 (mm)

CONT : 25  
VOL : 0.111

51

**A-5624** Air Filter Secondary Metal End Cap Element  
KOMATSU 144-01-B5620  
CATERPILLAR 3I-0375  
KOMATSU 6691-80-7212



Primary Filter uses A-5623  
Set Filter uses A-5622-S  
H 1 : 374 (mm)  
OD 1 : 146.2 (mm)  
OD 2 : 146.2 (mm)  
ID 1 : 88 (mm)  
ID 2 : 17 (mm)

CONT : 9  
VOL : 0.093

56

**A-5608-S** Air Filter Set Metal End Cap Element  
KOMATSU 6141-81-7030



Primary Filter uses A-5608  
Secondary Filter uses A-5609  
H 1 : 311.7 (mm)  
H 2 : 299 (mm)  
OD 1 : 179.5 (mm)  
OD 2 : 179.5 (mm)  
ID 1 : 101 (mm)  
ID 2 : 14 (mm)

CONT : 9  
VOL : 0.120

47

**A-5618** Air Filter Primary Metal End Cap Element  
NISSAN 16546-97004  
HINO 17801-2550  
HITACHI 4177213



Secondary Filter uses A-5610  
Set Filter uses A-5658-S  
H 1 : 469.7 (mm)  
H 2 : 457 (mm)  
OD 1 : 307 (mm)  
OD 2 : 307 (mm)  
ID 1 : 196 (mm)  
ID 2 : 17 (mm)

CONT : 1  
VOL : 0.054

52

**A-5627** Air Filter Primary Metal End Cap Element  
KOBELCO 2451-U311-3  
DAEWOO 2474-6006A  
DAEWOO 2474-6006B



Secondary Filter uses A-6008  
Set Filter uses A-5663-S  
H 1 : 393.7 (mm)  
H 2 : 381 (mm)  
OD 1 : 235 (mm)  
OD 2 : 187 (mm)  
ID 1 : 120 (mm)  
ID 2 : 17 (mm)

CONT : 1  
VOL : 0.026

57

**A-5610** Air Filter Secondary Metal End Cap Element  
NISSAN 16546-97005  
CATERPILLAR 3I-0125  
HITACHI 4177212



Primary Filter uses A-5614  
Set Filter uses A-5613-S  
H 1 : 449 (mm)  
OD 1 : 214.8 (mm)  
OD 2 : 185 (mm)  
ID 1 : 157.5 (mm)  
ID 2 : 17 (mm)

CONT : 4  
VOL : 0.099

Note : Is a Secondary Air filter for A-5614,A-5618

48

**A-5621** Air Filter Secondary Metal End Cap Element  
KOMATSU 600-181-7360  
KOMATSU 600-181-7400S



Primary Filter uses AS-5620  
Set Filter uses AS-5620-S  
H 1 : 242 (mm)  
H 2 : 237 (mm)  
OD 1 : 83 (mm)  
OD 2 : 83 (mm)  
ID 1 : 54 (mm)  
ID 2 : 17 (mm)

CONT : 25  
VOL : 0.062

53

**A-5628** Air Filter Primary Metal End Cap Element  
CHRYSLER 3614353  
KOMATSU 600-181-8240



Secondary Filter uses A-7611  
Set Filter uses A-5628-S  
H 1 : 311 (mm)  
H 2 : 305 (mm)  
OD 1 : 155 (mm)  
OD 2 : 155 (mm)  
ID 1 : 88 (mm)  
ID 2 : 17 (mm)

CONT : 12  
VOL : 0.120

58

**A-5614** Air Filter Primary Metal End Cap Element  
CATERPILLAR 3I-0374  
KOMATSU 600-181-4400  
KOMATSU 600-181-4400P



Secondary Filter uses A-5610  
Set Filter uses A-5613-S  
H 1 : 469.75 (mm)  
H 2 : 457 (mm)  
OD 1 : 307 (mm)  
OD 2 : 377 (mm)  
ID 1 : 196 (mm)  
ID 2 : 24 (mm)

CONT : 1  
VOL : 0.073

49

**A-5622-S** Air Filter Set Metal End Cap Element  
KOMATSU 6691-80-7210  
KOMATSU 6691-80-7211  
KOMATSU 6691-80-7212



Primary Filter uses A-5623  
Secondary Filter uses A-5624  
H 1 : 393.7 (mm)  
H 2 : 381 (mm)  
OD 1 : 234 (mm)  
OD 2 : 234 (mm)  
ID 1 : 123 (mm)  
ID 2 : 17 (mm)

CONT : 4  
VOL : 0.104

54

**A-5628-S** Air Filter Set Metal End Cap Element  
CLAAS 3200010+3200020  
BLOUNT 537986+537987  
BOBCAT 6681474+6681475  
JOHN DEERE AT44377+AT44378



Primary Filter uses A-5628  
Secondary Filter uses A-7611  
H 1 : 311 (mm)  
H 2 : 305 (mm)  
OD 1 : 155 (mm)  
OD 2 : 155 (mm)  
ID 1 : 88 (mm)  
ID 2 : 17 (mm)

CONT : 4  
VOL : 0.047

59

**A-5616** Air Filter Primary Metal End Cap Element  
KOMATSU 600-181-9220



Secondary Filter uses A-5617  
Set Filter uses A-5655-S  
H 1 : 331.7 (mm)  
H 2 : 319 (mm)  
OD 1 : 209 (mm)  
OD 2 : 209 (mm)  
ID 1 : 106.5 (mm)  
ID 2 : 14 (mm)

CONT : 9  
VOL : 0.159

50

**A-5623** Air Filter Primary Metal End Cap Element  
CATERPILLAR 3I-0376  
KOMATSU 600-181-3300  
KOMATSU 6691-81-7210



Secondary Filter uses A-5624  
Set Filter uses A-5622-S  
H 1 : 393.7 (mm)  
H 2 : 381 (mm)  
OD 1 : 234 (mm)  
OD 2 : 234 (mm)  
ID 1 : 123 (mm)  
ID 2 : 17 (mm)

CONT : 4  
VOL : 0.105

55

**A-5629** Air Filter Primary Metal End Cap Element  
ISUZU 1-14125082-0  
ISUZU 1-14215082-0  
CATERPILLAR 3I-0202



Secondary Filter uses A-5630  
Set Filter uses A-5629-S  
H 1 : 622 (mm)  
H 2 : 609.5 (mm)  
OD 1 : 307 (mm)  
OD 2 : 307 (mm)  
ID 1 : 196 (mm)  
ID 2 : 22.7 (mm)

CONT : 1  
VOL : 0.071

60

# Sakura Filter

# Technical Specification

**A-5629-S** Air Filter Set Metal End Cap Element

HITACHI 4240294+4240295  
KOMATSU  
561-02-12330+561-02-12320



Primary Filter uses A-5629  
Secondary Filter uses A-5630  
H 1 : 622 (mm)  
H 2 : 609.5 (mm)  
OD 1 : 307 (mm)  
OD 2 : 307 (mm)  
ID 1 : 196 (mm)  
ID 2 : 22.7 (mm)

CONT : 1  
VOL : 0.071

**A-5637** Air Filter Primary Metal End Cap Element

KOMATSU 6675-81-7230  
KOMATSU 6675-81-7231



Secondary Filter uses A-5642  
Set Filter uses A-5607-S  
H 1 : 224 (mm)  
OD 1 : 245 (mm)  
OD 2 : 245 (mm)  
ID 1 : 132 (mm)

CONT : 4  
VOL : 0.072

Note : primary A-5636+A-5637

**A-5655-S** Air Filter Set Metal End Cap Element

KOMATSU 600-181-9300  
KOMATSU 600-181-9301



Primary Filter uses A-5616  
Secondary Filter uses A-5617  
H 1 : 331.7 (mm)  
H 2 : 319 (mm)  
OD 1 : 209 (mm)  
OD 2 : 209 (mm)  
ID 1 : 106.5 (mm)  
ID 2 : 14 (mm)

CONT : 9  
VOL : 0.159

**A-5630** Air Filter Secondary Metal End Cap Element

ISUZU 1-14215081-0  
CATERPILLAR 3I-0203  
HITACHI 4240295



Primary Filter uses A-5629  
Set Filter uses A-5629-S  
H 1 : 596.7 (mm)  
H 2 : 584 (mm)  
OD 1 : 185 (mm)  
OD 2 : 185 (mm)  
ID 1 : 157.5 (mm)  
ID 2 : 17 (mm)

CONT : 1  
VOL : 0.025

**A-5639** Air Filter Primary Metal End Cap Element

KOBELCO 2451-U324-3  
MITSUBISHI 3433000400



Secondary Filter uses A-5635  
Set Filter uses A-5654-S  
H 1 : 454.7 (mm)  
H 2 : 442 (mm)  
OD 1 : 263.5 (mm)  
OD 2 : 221 (mm)  
ID 1 : 136 (mm)  
ID 2 : 23 (mm)

CONT : 1  
VOL : 0.036

**A-5657-S** Air Filter Set Metal End Cap Element

KOMATSU 6110-80-7300  
KOMATSU 6110-80-7300(SET)  
KOMATSU 6610-80-7300



Primary Filter uses A-5649  
Secondary Filter uses A-5633  
H 1 : 425.8 (mm)  
H 2 : 413.5 (mm)  
OD 1 : 214 (mm)  
OD 2 : 213.5 (mm)  
ID 1 : 107 (mm)

CONT : 4  
VOL : 0.100

**A-5631** Air Filter Secondary Metal End Cap Element

ISUZU 1-14215087-0  
NISSAN 16546-96072  
HITACHI 4288964



Primary Filter uses A-1013  
Set Filter uses A-1841-S  
H 1 : 361.75 (mm)  
H 2 : 349 (mm)  
OD 1 : 162.5 (mm)  
OD 2 : 163 (mm)  
ID 1 : 134 (mm)  
ID 2 : 17 (mm)

CONT : 9  
VOL : 0.110

**A-5647** Air Filter Secondary Metal End Cap Element

KOMATSU 600-181-9480



Primary Filter uses A-7939  
Set Filter uses A-5652-S  
H 1 : 280.6 (mm)  
H 2 : 280 (mm)  
OD 1 : 105 (mm)  
OD 2 : 85.5 (mm)  
ID 1 : 73.5 (mm)  
ID 2 : 17 (mm)

CONT : 12  
VOL : 0.055

**A-5660-S** Air Filter Set Metal End Cap Element

KOMATSU 044-3510-22411  
CATERPILLAR 3I-0260+3I-0254  
INTERNATIONAL HARVESTER  
627934C1+627935C1



Primary Filter uses A-5413  
Secondary Filter uses A-5414  
H 1 : 305 (mm)  
H 2 : 254 (mm)  
OD 1 : 264 (mm)  
OD 2 : 151 (mm)  
ID 1 : 153 (mm)  
ID 2 : 17 (mm)

CONT : 1  
VOL : 0.027

**A-5635** Air Filter Secondary Metal End Cap Element

DAEWOO 2474-9054  
KOMATSU 600-181-6730  
MITSUBISHI ME033839



Primary Filter uses A-5639  
Set Filter uses A-5654-S  
H 1 : 414.75 (mm)  
H 2 : 402 (mm)  
OD 1 : 133.5 (mm)  
OD 2 : 133.5 (mm)  
ID 1 : 105 (mm)  
ID 2 : 17 (mm)

CONT : 9  
VOL : 0.086

**A-5649** Air Filter Primary Metal End Cap Element

CATERPILLAR 3I-0869  
KOMATSU 600-3000-110



Secondary Filter uses A-5633  
Set Filter uses A-5657-S  
H 1 : 425.8 (mm)  
H 2 : 413 (mm)  
OD 1 : 214 (mm)  
OD 2 : 213.5 (mm)  
ID 1 : 107 (mm)

CONT : 4  
VOL : 0.097

**A-5662-S** Air Filter Set Metal End Cap Element

KOMATSU 600-181-8600  
KOMATSU 600-182-2700  
KOMATSU 600-182-3200



Primary Filter uses A-1313  
Secondary Filter uses A-1307  
H 1 : 457 (mm)  
H 2 : 432 (mm)  
OD 1 : 232 (mm)  
OD 2 : 145 (mm)  
ID 1 : 147 (mm)  
ID 2 : 23 (mm)

CONT : 4  
VOL : 0.123

**A-5636** Air Filter Primary Metal End Cap Element

KOMATSU 6675-81-7020  
KOMATSU 6675-81-7021



Secondary Filter uses A-5642  
Set Filter uses A-5607-S  
H 1 : 249.4 (mm)  
H 2 : 224 (mm)  
OD 1 : 245 (mm)  
OD 2 : 245 (mm)  
ID 1 : 132 (mm)  
ID 2 : 132 (mm)

CONT : 4  
VOL : 0.079

Note : Primary A-5636+A-5637

**A-5652-S** Air Filter Set Metal End Cap Element

KOMATSU 600-181-9450



Primary Filter uses A-7939  
Secondary Filter uses A-5647  
H 1 : 315.3 (mm)  
H 2 : 305 (mm)  
OD 1 : 155 (mm)  
OD 2 : 191 (mm)  
ID 1 : 88 (mm)  
ID 2 : 17 (mm)

CONT : 12  
VOL : 0.200

**A-5663-S** Air Filter Set Metal End Cap Element

KOMATSU 600-181-6050



Primary Filter uses A-5627  
Secondary Filter uses A-6008  
H 1 : 380 (mm)  
H 2 : 330 (mm)  
OD 1 : 235 (mm)  
OD 2 : 187 (mm)  
ID 1 : 120 (mm)  
ID 2 : 17 (mm)

CONT : 1  
VOL : 0.030

# Sakura Filter

# Technical Specification

**A-5666** Air Filter Primary Soft PU end cap Element

KOMATSU 1308462H1  
KOMATSU 600-185-4110  
JOHN DEERE AT178516



Secondary Filter uses A-5667  
Set Filter uses A-5668-S  
H 1 : 483 (mm)  
H 2 : 470 (mm)  
OD 1 : 237 (mm)  
OD 2 : 237 (mm)  
ID 1 : 132 (mm)

CONT : 1  
VOL : 0.031

76

**A-56731-S** Air Filter Set Soft PU end cap Element

MANITOU 77549+775480



Primary Filter uses A-56731  
Secondary Filter uses A-56741  
H 1 : 395 (mm)  
H 2 : 385 (mm)  
OD 1 : 186 (mm)  
OD 2 : 184 (mm)  
ID 1 : 87 (mm)

CONT : 0  
VOL : 0.000

81

**A-5715** Air Filter Secondary Metal End Cap Element

CATERPILLAR 1N-4864  
CUMMINS 3013213  
CATERPILLAR 3I-0215



Primary Filter uses A-5718  
Set Filter uses A-5718-S  
H 1 : 571.75 (mm)  
H 2 : 559 (mm)  
OD 1 : 260 (mm)  
OD 2 : 260 (mm)  
ID 1 : 231.5 (mm)  
ID 2 : 23 (mm)

CONT : 1  
VOL : 0.047

86

**A-5667** Air Filter Secondary Soft PU end cap Element

KOMATSU 1308463H1  
CASE 249988A1  
KOMATSU 600-185-4120



Primary Filter uses A-5666  
Set Filter uses A-5668-S  
H 1 : 469 (mm)  
H 2 : 463 (mm)  
OD 1 : 133.8 (mm)  
OD 2 : 125 (mm)  
ID 1 : 95.5 (mm)

CONT : 9  
VOL : 0.097

77

**A-5674** Air Filter Secondary Soft PU end cap Element

KOMATSU 600-185-2520



Primary Filter uses A-5673  
Set Filter uses A-5675-S  
H 1 : 382 (mm)  
H 2 : 377 (mm)  
OD 1 : 107.5 (mm)  
OD 2 : 101.5 (mm)  
ID 1 : 89 (mm)

CONT : 25  
VOL : 0.204

82

**A-5718** Air Filter Primary Metal End Cap Element

CUMMINS 3013212  
CATERPILLAR 3I-0795  
HITACHI 4206272



Secondary Filter uses A-5715  
Set Filter uses A-5718-S  
H 1 : 622.7 (mm)  
H 2 : 610 (mm)  
OD 1 : 373 (mm)  
OD 2 : 373 (mm)  
ID 1 : 262.5 (mm)  
ID 2 : 23 (mm)

CONT : 1  
VOL : 0.102

87

**A-5671** Air Filter Secondary Metal End Cap Element

KOMATSU 205-01-K1480



Primary Filter uses AS-5670  
Set Filter uses AS-5672-S  
H 1 : 416.7 (mm)  
H 2 : 407 (mm)  
OD 1 : 116.5 (mm)  
OD 2 : 116.5 (mm)  
ID 1 : 88 (mm)  
ID 2 : 17 (mm)

CONT : 25  
VOL : 0.193

78

**A-56741** Air Filter Secondary Soft PU end cap Element

MANITOU 775480



Primary Filter uses A-56731  
Set Filter uses A-56731-S  
H 1 : 382.5 (mm)  
H 2 : 378 (mm)  
OD 1 : 106 (mm)  
OD 2 : 100 (mm)  
ID 1 : 87 (mm)

CONT : 0  
VOL : 0.000

83

**A-57240** Air Filter Metal End Cap Element

CASE 346777R91



H 1 : 266.7 (mm)  
H 2 : 254 (mm)  
OD 1 : 307 (mm)  
OD 2 : 307 (mm)  
ID 1 : 196 (mm)  
ID 2 : 14 (mm)

CONT : 1  
VOL : 0.030

Note : Without Gasket Uses A-5704

88

**A-5673** Air Filter Primary Soft PU end cap Element

YANMAR 172660-13840  
CATERPILLAR 206-5234  
KOMATSU 600-185-2510



Secondary Filter uses A-5674  
Set Filter uses A-5675-S  
H 1 : 392 (mm)  
H 2 : 384 (mm)  
OD 1 : 186 (mm)  
OD 2 : 186 (mm)  
ID 1 : 106 (mm)

CONT : 9  
VOL : 0.169

79

**A-5675-S** Air Filter Set Soft PU end cap Element

KOMATSU 600-185-2500



Primary Filter uses A-5673  
Secondary Filter uses A-5674  
H 1 : 392 (mm)  
H 2 : 384 (mm)  
OD 1 : 186 (mm)  
OD 2 : 186 (mm)  
ID 1 : 106 (mm)

CONT : 1  
VOL : 0.018

84

**A-6003** Air Filter Metal End Cap Element

ISUZU 9-14215026-0  
ISUZU 9-14215138-0



H 1 : 141.5 (mm)  
H 2 : 122 (mm)  
OD 1 : 250 (mm)  
OD 2 : 250 (mm)  
ID 1 : 144 (mm)  
ID 2 : 144 (mm)

CONT : 1  
VOL : 0.011

89

**A-56731** Air Filter Primary Soft PU end cap Element

MANITOU 775479



Secondary Filter uses A-56741  
Set Filter uses A-56731-S  
H 1 : 394.5 (mm)  
H 2 : 385 (mm)  
OD 1 : 186 (mm)  
OD 2 : 184 (mm)  
ID 1 : 105.5 (mm)

CONT : 1  
VOL : 0.000

80

**A-5677** Air Filter Metal End Cap Element

MITSUBISHI 32143-08300  
KOMATSU 600-181-6340



H 1 : 254 (mm)  
OD 1 : 159 (mm)  
OD 2 : 130 (mm)  
ID 1 : 84 (mm)  
ID 2 : 17 (mm)

CONT : 10  
VOL : 0.089

Note : A-1029 (Height Difference)

85

**A-6008** Air Filter Secondary Metal End Cap Element

ISUZU 1-14215047-0  
ISUZU 1-1425-046-1  
NISSAN 16546-96010



Primary Filter uses A-5627  
Set Filter uses A-5663-S  
H 1 : 330 (mm)  
OD 1 : 146 (mm)  
OD 2 : 116.5 (mm)  
ID 1 : 88 (mm)  
ID 2 : 17 (mm)

CONT : 9  
VOL : 0.083

90

# Sakura Filter

# Technical Specification

**A-6009** Air Filter Secondary Metal End Cap Element



NISSAN 16546-96004  
KOBELCO 2451U180-3B  
KOBELCO 2451U206-3  
KOMATSU 600-181-8360  
ISUZU 9-14215017-0

Primary Filter uses AS-1024  
Set Filter uses AS-1024-S

H 1 : 397 (mm)  
H 2 : 397 (mm)  
OD 1 : 146.2 (mm)  
OD 2 : 166.5 (mm)  
ID 1 : 88 (mm)  
ID 2 : 17 (mm)

CONT : 9  
VOL : 0.101

**A-6207** Air Filter Primary Metal End Cap Element



MERCEDES-BENZ 001 094 42 04  
MERCEDES-BENZ 001 094 52 04  
IVECO 02165049

Secondary Filter uses A-6302  
Set Filter uses A-6207-S

H 1 : 374.7 (mm)  
H 2 : 362 (mm)  
OD 1 : 197.5 (mm)  
OD 2 : 197.5 (mm)  
ID 1 : 103.5 (mm)  
ID 2 : 9 (mm)

CONT : 9  
VOL : 0.163

**A-6809** Air Filter Metal End Cap Element



COMP AIR C 16012/52

H 1 : 240.75 (mm)  
H 2 : 228 (mm)  
OD 1 : 164 (mm)  
OD 2 : 164 (mm)  
ID 1 : 86 (mm)

CONT : 18  
VOL : 0.165

**A-6010** Air Filter Primary Metal End Cap Element



ISUZU 1-14215116-0  
ISUZU 1-14215117-0  
ISUZU 1-14215128-0

Secondary Filter uses A-6011  
Set Filter uses A-6010-S

H 1 : 495.7 (mm)  
H 2 : 483 (mm)  
OD 1 : 307 (mm)  
OD 2 : 307 (mm)  
ID 1 : 196 (mm)  
ID 2 : 23 (mm)

CONT : 1  
VOL : 0.060

**A-6211** Air Filter Primary Metal End Cap Element



MERCEDES-BENZ 001 094 46 04  
DEUTZ 2165044

Secondary Filter uses A-6212  
Set Filter uses A-6211-S

H 1 : 352.7 (mm)  
H 2 : 340 (mm)  
OD 1 : 164 (mm)  
OD 2 : 164 (mm)  
ID 1 : 87 (mm)  
ID 2 : 8.5 (mm)

CONT : 9  
VOL : 0.108

**A-7003** Air Filter Primary Soft PU end cap Element



FIAT 1930587  
PERKINS 26510337  
FIAT 366-08109

Secondary Filter uses A-7004  
Set Filter uses A-7003-S

H 1 : 327.8 (mm)  
H 2 : 319 (mm)  
OD 1 : 138 (mm)  
OD 2 : 138 (mm)  
ID 1 : 81 (mm)

CONT : 1  
VOL : 0.008

**A-6011** Air Filter Secondary Metal End Cap Element



ISUZU 1-14215118-0  
ISUZU 1-14215127-0  
ISUZU 14215-127

Primary Filter uses A-6010  
Set Filter uses A-6010-S

H 1 : 469.7 (mm)  
H 2 : 457 (mm)  
OD 1 : 185 (mm)  
OD 2 : 185 (mm)  
ID 1 : 157.5 (mm)  
ID 2 : 17 (mm)

CONT : 9  
VOL : 0.190

**A-6212** Air Filter Secondary Aluminium casting end cap, Element



DEUTZ 2985037  
VOLVO 4765611

Primary Filter uses A-6211

H 1 : 346 (mm)  
OD 1 : 90 (mm)  
OD 2 : 82 (mm)  
ID 1 : 71 (mm)  
ID 2 : 17 (mm)

CONT : 25  
VOL : 0.089

**A-7004** Air Filter Secondary Soft PU end cap Element



FIAT 1930588  
PERKINS 26510338

Primary Filter uses A-7003  
Set Filter uses A-7003-S

H 1 : 319 (mm)  
H 2 : 312 (mm)  
OD 1 : 84 (mm)  
OD 2 : 79 (mm)  
ID 1 : 63 (mm)

CONT : 25  
VOL : 0.082

**A-6113** Air Filter Primary Metal End Cap Element



FIAT 01901779  
ISUZU 1-14215046-0  
NISSAN 16546-96017

Secondary Filter uses A-5408  
Set Filter uses A-5653-S

H 1 : 418.7 (mm)  
H 2 : 406 (mm)  
OD 1 : 282 (mm)  
OD 2 : 282 (mm)  
ID 1 : 171 (mm)  
ID 2 : 17 (mm)

CONT : 1  
VOL : 0.038

**A-6302** Air Filter Secondary Metal End Cap Element



MERCEDES-BENZ 002 094 32 04  
DEUTZ 2241329  
HITACHI 5025800

Primary Filter uses A-6207  
Set Filter uses A-6207-S

H 1 : 373 (mm)  
OD 1 : 110 (mm)  
OD 2 : 99.5 (mm)  
ID 1 : 90.4 (mm)  
ID 2 : 17 (mm)

CONT : 16  
VOL : 0.088

**A-7105** Air Filter Secondary Soft PU end cap Element



VOLVO 11110176  
J.C.BAMFORD 32/925405  
KOMATSU 41901H0P09  
LIEBHERR 7623372  
RENAULT 7700050841

Primary Filter uses A-7106  
Set Filter uses A-7107-S

H 1 : 454 (mm)  
H 2 : 448 (mm)  
OD 1 : 134 (mm)  
OD 2 : 125 (mm)  
ID 1 : 95.5 (mm)

CONT : 25  
VOL : 0.256

**A-6201** Air Filter Primary Metal End Cap Element



MERCEDES-BENZ 001 094 82 04  
DEUTZ 2165038

Secondary Filter uses A-5309  
Set Filter uses A-6201-S

H 1 : 337.7 (mm)  
H 2 : 325 (mm)  
OD 1 : 148 (mm)  
OD 2 : 148 (mm)  
ID 1 : 72 (mm)  
ID 2 : 8.5 (mm)

CONT : 9  
VOL : 0.093

**A-6808** Air Filter Primary Metal End Cap Element



RENAULT 00 03 563 577  
MERCEDES-BENZ 001 094 45 04  
CATERPILLAR 060 129 620  
MASSEY-FERGUSON 3 252 002 M 1

Secondary Filter uses A-5114  
Set Filter uses A-6808-S

H 1 : 294 (mm)  
H 2 : 284 (mm)  
OD 1 : 126 (mm)  
OD 2 : 126 (mm)  
ID 1 : 66 (mm)  
ID 2 : 9 (mm)

CONT : 10  
VOL : 0.071

**A-7106** Air Filter Primary Soft PU end cap Element



VOLVO 11110175  
J.C.BAMFORD 32/925404  
RENAULT 7700050840

Secondary Filter uses A-7105  
Set Filter uses A-7107-S

H 1 : 473 (mm)  
H 2 : 460 (mm)  
OD 1 : 237 (mm)  
OD 2 : 237 (mm)  
ID 1 : 132 (mm)

CONT : 4  
VOL : 0.128

**A-71330** Air Filter Breather Hard PU end cap Element



VOLVO 14500233  
KOMATSU 207-60-51310  
HYUNDAI 31EE-02110  
NEW HOLLAND (CNH) 47587350  
J.C.BAMFORD KRJ3461

H 1 : 39 (mm)  
H 2 : 31.5 (mm)  
OD 1 : 54.5 (mm)  
OD 2 : 54.5 (mm)  
ID 1 : 31 (mm)  
ID 2 : 31 (mm)

CONT : 100  
VOL : 0.017

**A-7610-S** Air Filter Set Metal End Cap Element



JOHN DEERE AT35155+AT31227

Primary Filter uses A-7610  
Secondary Filter uses A-7608

H 1 : 317.7 (mm)  
H 2 : 305 (mm)  
OD 1 : 201.5 (mm)  
OD 2 : 201.5 (mm)  
ID 1 : 135.5 (mm)  
ID 2 : 17 (mm)

CONT : 4  
VOL : 0.069

**A-7631** Air Filter Metal End Cap Element



CUMMINS 4099423  
JOHN DEERE AR61967  
JOHN DEERE AR79679

H 1 : 435.2 (mm)  
H 2 : 425.5 (mm)  
OD 1 : 230.6 (mm)  
OD 2 : 230.6 (mm)  
ID 1 : 133 (mm)  
ID 2 : 10 (mm)

CONT : 4  
VOL : 0.115

**A-71360** Air Filter Primary Soft PU end cap Element



LIEBHERR 10330469  
VOLVO 43904168  
FORD 6E7Z-9601-AA  
JOHN DEERE AT300487

Secondary Filter uses A-71370  
Set Filter uses A-71380-S

H 1 : 425 (mm)  
OD 1 : 225 (mm)  
OD 2 : 225 (mm)  
ID 1 : 130 (mm)

CONT : 4  
VOL : 0.107

**A-7614** Air Filter Secondary Metal End Cap Element



JOHN DEERE AR-85241

Primary Filter uses A-7615  
Set Filter uses A-7615-S

H 1 : 442.75 (mm)  
H 2 : 430 (mm)  
OD 1 : 162.5 (mm)  
OD 2 : 163 (mm)  
ID 1 : 134 (mm)  
ID 2 : 17 (mm)

CONT : 9  
VOL : 0.135

**A-7632** Air Filter Secondary Metal End Cap Element



KOMATSU 1251529H1  
TIMBERJACK 413283  
JOHN DEERE AR61968  
JOHN DEERE AR79680

Primary Filter uses A-7631  
Set Filter uses A-7633-S

H 1 : 360.4 (mm)  
H 2 : 355.6 (mm)  
OD 1 : 119 (mm)  
OD 2 : 119 (mm)  
ID 1 : 100 (mm)  
ID 2 : 16 (mm)

CONT : 9  
VOL : 0.065

**A-7605** Air Filter Secondary Metal End Cap Element



CASE 537335R1  
FIAT 79022026  
JOHN DEERE AL27159

Primary Filter uses AS-7609  
Set Filter uses AS-7609-S

H 1 : 280.7 (mm)  
H 2 : 279.4 (mm)  
OD 1 : 92.5 (mm)  
OD 2 : 75 (mm)  
ID 1 : 61 (mm)  
ID 2 : 17 (mm)

CONT : 25  
VOL : 0.089

**A-7615** Air Filter Primary Metal End Cap Element



JOHN DEERE AR-85242

Secondary Filter uses A-7614  
Set Filter uses A-7615-S

H 1 : 469.75 (mm)  
H 2 : 457 (mm)  
OD 1 : 276 (mm)  
OD 2 : 275 (mm)  
ID 1 : 165 (mm)  
ID 2 : 23 (mm)

CONT : 1  
VOL : 0.045

**A-7633-S** Air Filter Set Metal End Cap Element



JOHN DEERE AR79679+AR79680

Primary Filter uses A-7631  
Secondary Filter uses A-7632

H 1 : 435.2 (mm)  
H 2 : 425.5 (mm)  
OD 1 : 230.6 (mm)  
OD 2 : 230.6 (mm)  
ID 1 : 133 (mm)  
ID 2 : 10 (mm)

CONT : 4  
VOL : 0.115

**A-7608** Air Filter Secondary Metal End Cap Element



ISUZU 1-14215031-0  
INTERNATIONAL HARVESTER 110571BC1  
CATERPILLAR 3I-0187

Primary Filter uses A-2701  
Set Filter uses A-2712-S

H 1 : 285.9 (mm)  
H 2 : 279.5 (mm)  
OD 1 : 116.5 (mm)  
OD 2 : 116.5 (mm)  
ID 1 : 88 (mm)  
ID 2 : 17 (mm)

CONT : 25  
VOL : 0.135

Note : Is a Secondary Air filter for A-2701,A-7610

**A-7615-S** Air Filter Set Metal End Cap Element



JOHN DEERE AR85242+AR85241

Primary Filter uses A-7615  
Secondary Filter uses A-7614

H 1 : 469.75 (mm)  
H 2 : 457 (mm)  
OD 1 : 276 (mm)  
OD 2 : 275 (mm)  
ID 1 : 165 (mm)  
ID 2 : 23 (mm)

CONT : 1  
VOL : 0.045

**A-76560** Air Filter Secondary Metal End Cap Element



CATERPILLAR 3I0207  
HITACHI 79933226  
JOHN DEERE RE45828

Primary Filter uses AS-76550  
Set Filter uses AS-76570-S

H 1 : 304.5 (mm)  
H 2 : 303 (mm)  
OD 1 : 107.5 (mm)  
OD 2 : 85.5 (mm)  
ID 1 : 73 (mm)  
ID 2 : 17 (mm)

CONT : 25  
VOL : 0.133

**A-7610** Air Filter Primary Metal End Cap Element



JOHN DEERE AT-35155

Secondary Filter uses A-7608  
Set Filter uses A-7610-S

H 1 : 317.7 (mm)  
H 2 : 305 (mm)  
OD 1 : 201.5 (mm)  
OD 2 : 201.5 (mm)  
ID 1 : 135.5 (mm)  
ID 2 : 17 (mm)

CONT : 12  
VOL : 0.200

**A-7618** Air Filter Secondary Soft PU end cap Element



YANMAR 119233-12700  
MITSUBISHI 32143-11400  
JOHN DEERE M123378

Primary Filter uses A-8504  
Set Filter uses A-7620-S

H 1 : 173 (mm)  
H 2 : 168 (mm)  
OD 1 : 44 (mm)  
OD 2 : 43 (mm)  
ID 1 : 32 (mm)

CONT : 50  
VOL : 0.037

**A-7806** Air Filter Secondary Metal End Cap Element



YANMAR 119131-12520  
ISUZU 14215-167  
DAEWOO 2474-9014

Primary Filter uses AS-7805  
Set Filter uses AS-5656-S

H 1 : 337 (mm)  
H 2 : 330 (mm)  
OD 1 : 85.5 (mm)  
OD 2 : 85.5 (mm)  
ID 1 : 57.5 (mm)  
ID 2 : 17 (mm)

CONT : 25  
VOL : 0.106

Note : Is a secondary Air Filter for AS-7805,AS-7813,A-7805

# Sakura Filter

# Technical Specification

**A-7809** Air Filter Secondary Metal End Cap Element



NISSAN 16546-Z5003  
ATLAS COPCO 3216-708202  
CATERPILLAR 3I-0069  
JOHN DEERE T46317

Primary Filter uses A-7954  
Set Filter uses A-7954-S  
H 1 : 387.4 (mm)  
H 2 : 381 (mm)  
OD 1 : 116.5 (mm)  
OD 2 : 116.5 (mm)  
ID 1 : 88 (mm)  
ID 2 : 17 (mm)

CONT : 25  
VOL : 0.178

121

**A-7919** Air Filter Secondary Metal End Cap Element



INTERNATIONAL HARVESTER 1043327M91  
YANMAR 171064-12520  
YANMAR 171064-12550

Primary Filter uses AS-5644  
Set Filter uses AS-5644-S  
H 1 : 253.5 (mm)  
H 2 : 253 (mm)  
OD 1 : 81 (mm)  
OD 2 : 64.5 (mm)  
ID 1 : 55 (mm)  
ID 2 : 17 (mm)

CONT : 12  
VOL : 0.025

126

**A-8505** Air Filter Primary Soft PU end cap Element



OPEL 1#123 84 075  
OPEL 1-12384075  
SUNWARD 730403000155

Secondary Filter uses A-8599  
Set Filter uses A-8602-S  
H 1 : 312 (mm)  
H 2 : 304 (mm)  
OD 1 : 127.5 (mm)  
OD 2 : 127.5 (mm)  
ID 1 : 83 (mm)

CONT : 16  
VOL : 0.109

Note : For Flame Retardant version, use A-76410

131

**A-7902** Air Filter Secondary Metal End Cap Element



HITACHI 4331920  
CATERPILLAR 9Y-7663

Primary Filter uses A-9217  
Set Filter uses A-9217-S  
H 1 : 563.35 (mm)  
H 2 : 550.6 (mm)  
OD 1 : 276 (mm)  
OD 2 : 276 (mm)  
ID 1 : 207.5 (mm)  
ID 2 : 22.7 (mm)

CONT : 1  
VOL : 0.048

122

**A-7939** Air Filter Primary Metal End Cap Element



KOMATSU 600-181-9460  
KOMATSU 600-181-9470

Secondary Filter uses A-5647  
Set Filter uses A-5652-S  
H 1 : 315 (mm)  
H 2 : 305.5 (mm)  
OD 1 : 155 (mm)  
OD 2 : 191 (mm)  
ID 1 : 88 (mm)  
ID 2 : 17 (mm)

CONT : 12  
VOL : 0.175

127

**A-8506** Air Filter Primary Soft PU end cap Element



CASE 222425A1  
ISUZU 8-97231900-0  
JOHN DEERE KV16428

Secondary Filter uses A-8565  
H 1 : 330.8 (mm)  
H 2 : 322 (mm)  
OD 1 : 138 (mm)  
OD 2 : 138 (mm)  
ID 1 : 81 (mm)

CONT : 12  
VOL : 0.099

132

**A-7912** Air Filter Primary Metal End Cap Element



HITACHI 408065  
CASE 45252  
STEIGER 45252  
INGERSOLL RAND 506163930

Secondary Filter uses A-7915  
Set Filter uses A-7912-S  
H 1 : 469.75 (mm)  
H 2 : 457 (mm)  
OD 1 : 352 (mm)  
OD 2 : 352 (mm)  
ID 1 : 241 (mm)  
ID 2 : 23 (mm)

CONT : 1  
VOL : 0.070

123

**A-7964** Air Filter Secondary Metal End Cap Element



IVECO 08015449  
MASSEY-FERGUSON 1093683M91  
FIAT-ALLIS 1909964

Primary Filter uses AS-7988  
Set Filter uses AS-7988-S  
H 1 : 357 (mm)  
H 2 : 355.5 (mm)  
OD 1 : 105 (mm)  
OD 2 : 85.5 (mm)  
ID 1 : 73.5 (mm)  
ID 2 : 17 (mm)

CONT : 25  
VOL : 0.141

Note : Is a Secondary Air filter for AS-7988,AS-7813,AS-7805,AS-4304

128

**A-8506-S** Air Filter Set Soft PU end cap Element



CASE 222425A1+222429A1  
JOHN DEERE KV16428+AP33331

Primary Filter uses A-8506  
Secondary Filter uses A-8565  
H 1 : 330.8 (mm)  
H 2 : 322 (mm)  
OD 1 : 138 (mm)  
OD 2 : 138 (mm)  
ID 1 : 81 (mm)

CONT : 12  
VOL : 0.099

133

**A-7912-S** Air Filter Set Metal End Cap Element



VOLVO 4881174 + 4881175  
EUCLID 9035992+9035993

Primary Filter uses A-7912  
Secondary Filter uses A-7915  
H 1 : 469.75 (mm)  
H 2 : 457 (mm)  
OD 1 : 352 (mm)  
OD 2 : 352 (mm)  
ID 1 : 241 (mm)  
ID 2 : 23 (mm)

CONT : 1  
VOL : 0.070

124

**A-82010** Air Filter Breather Hard PU end cap Element



KOMATSU 421-60-35170

H 1 : 32.5 (mm)  
H 2 : 31 (mm)  
OD 1 : 55 (mm)  
OD 2 : 55 (mm)  
ID 1 : 22 (mm)  
ID 2 : 26 (mm)

CONT : 100  
VOL : 0.014

129

**A-8513** Air Filter Primary Soft PU end cap Element



YANMAR 119808-12520  
NISSAN 16546-FJ100  
KOMATSU 3EB-02-38730  
SUNWARD 730403000157

Secondary Filter uses A-5569  
Set Filter uses A-5570-S  
H 1 : 273.5 (mm)  
H 2 : 265 (mm)  
OD 1 : 104 (mm)  
OD 2 : 104 (mm)  
ID 1 : 61 (mm)

CONT : 25  
VOL : 0.110

Note : A-85134(with Flame Retardant Media)

134

**A-7915** Air Filter Secondary Metal End Cap Element



CATERPILLAR 1N-8164  
CATERPILLAR 4N-9164  
INGERSOLL RAND 50616408

Primary Filter uses A-7912  
Set Filter uses A-7912-S  
H 1 : 432.7 (mm)  
H 2 : 423 (mm)  
OD 1 : 220 (mm)  
OD 2 : 220 (mm)  
ID 1 : 179 (mm)  
ID 2 : 23 (mm)

CONT : 4  
VOL : 0.104

125

**A-8504** Air Filter Primary Soft PU end cap Element



YANMAR 119655-12560  
KOMATSU 11965512560  
KUBOTA 1G659-11220

Secondary Filter uses A-7618  
Set Filter uses A-7620-S  
H 1 : 187 (mm)  
H 2 : 179 (mm)  
OD 1 : 88.5 (mm)  
OD 2 : 88.5 (mm)  
ID 1 : 46 (mm)

CONT : 25  
VOL : 0.055

130

**A-8521** Air Filter Primary Metal End Cap Element



INTERNATIONAL HARVESTER 1298058H1  
JOHN DEERE AR82915

Secondary Filter uses A-8522  
Set Filter uses A-8521-S  
H 1 : 504.7 (mm)  
H 2 : 492 (mm)  
OD 1 : 230 (mm)  
OD 2 : 230 (mm)  
ID 1 : 121 (mm)  
ID 2 : 10 (mm)

CONT : 4  
VOL : 0.134

135

# Sakura Filter

# Technical Specification

**A-8521-S** Air Filter Set Metal End Cap Element

INTERNATIONAL HARVESTER  
1298058HI+1298059HI



Primary Filter uses A-8521  
Secondary Filter uses A-8522  
H 1 : 504.7 (mm)  
H 2 : 492 (mm)  
OD 1 : 230 (mm)  
OD 2 : 230 (mm)  
ID 1 : 121 (mm)  
ID 2 : 10 (mm)

CONT : 4  
VOL : 0.134

136

**A-8568** Air Filter Metal End Cap Element

KUBOTA 121422-12570  
YANMAR 121422-12570  
KUBOTA 15287-11490  
CASE 167817A1  
HITACHI 4311871



H 1 : 232 (mm)  
H 2 : 228.5 (mm)  
OD 1 : 62.5 (mm)  
OD 2 : 62.5 (mm)  
ID 1 : 49 (mm)  
ID 2 : 17 (mm)

CONT : 25  
VOL : 0.038

141

**A-8580** Air Filter Secondary Soft PU end cap Element

CATERPILLAR 142-1403  
ATLAS COPCO 3222-1881-92  
HITACHI 4466268



Primary Filter uses A-8579  
Set Filter uses A-8579-S  
H 1 : 500 (mm)  
H 2 : 494 (mm)  
OD 1 : 179 (mm)  
OD 2 : 174 (mm)  
ID 1 : 148 (mm)

CONT : 1  
VOL : 0.019

Note : Is a Secondary Air filter of A-8579M,A-8665M

146

**A-8522** Air Filter Secondary Metal End Cap Element

INTERNATIONAL HARVESTER  
1298059HI  
JOHN DEERE AR81313



Primary Filter uses A-8521  
Set Filter uses A-8521-S  
H 1 : 425.4 (mm)  
H 2 : 419 (mm)  
OD 1 : 119 (mm)  
OD 2 : 119 (mm)  
ID 1 : 100 (mm)  
ID 2 : 16 (mm)

CONT : 9  
VOL : 0.074

137

**A-8577** Air Filter Primary Soft PU end cap Element

PERKINS 26510353  
J.C.BAMFORD 32/912901  
KOMATSU 42X01H0P02



Secondary Filter uses A-8578  
Set Filter uses A-8577-S  
H 1 : 423 (mm)  
H 2 : 410 (mm)  
OD 1 : 207 (mm)  
OD 2 : 207 (mm)  
ID 1 : 106.5 (mm)

CONT : 1  
VOL : 0.021

142

**A-8599** Air Filter Secondary Soft PU end cap Element

KUBOTA 119005-12571  
CASE 133721A1  
HITACHI 4326841



Primary Filter uses A-8505  
Set Filter uses A-8602-S  
H 1 : 303.5 (mm)  
H 2 : 298 (mm)  
OD 1 : 83 (mm)  
OD 2 : 79 (mm)  
ID 1 : 64 (mm)

CONT : 25  
VOL : 0.076

Note : Is a Secondary Air filter for A-5669,A-8505

147

**A-85370** Air Filter Hard PU end cap Element inside-out flow

CASE 327491R91  
FIAT 70634446  
CLARK 946092  
FARR P24



H 1 : 205 (mm)  
Length 1 : 381 (mm)  
Width 1 : 267 (mm)

CONT : 1  
VOL : 0.026

Note : 24 tubes-4x6

138

**A-8578** Air Filter Secondary Soft PU end cap Element

J.C.BAMFORD 32/912902  
KOMATSU 42X01H0P01  
KOMATSU 600-185-3120



Primary Filter uses A-8577  
Set Filter uses A-8577-S  
H 1 : 407.5 (mm)  
H 2 : 401 (mm)  
OD 1 : 107 (mm)  
OD 2 : 100 (mm)  
ID 1 : 87 (mm)

CONT : 25  
VOL : 0.193

143

**A-8624** Air Filter Primary Soft PU end cap Element

FIAT-AGRI 1930587  
MANITOU 227959



Secondary Filter uses A-8625  
Set Filter uses A-8626-S  
H 1 : 321 (mm)  
H 2 : 312 (mm)  
OD 1 : 138 (mm)  
OD 2 : 138 (mm)  
ID 1 : 81 (mm)

CONT : 16  
VOL : 0.128

148

**A-85400** Air Filter Hard PU end cap Element inside-out flow

FIAT-ALLIS 70185824  
CLARK 945755  
FARR P48



H 1 : 205 (mm)  
Length 1 : 502 (mm)  
Width 1 : 385 (mm)

CONT : 1  
VOL : 0.051

Note : 48 Tubes--6 x 8

139

**A-8579M** Air Filter Primary Soft PU+Metal Element

CATERPILLAR 142-1340  
FIAT 4466269  
KOMATSU 600-185-6110  
HITACHI 76612497



Secondary Filter uses A-8580  
Set Filter uses A-8579M-S  
H 1 : 521 (mm)  
H 2 : 510 (mm)  
OD 1 : 313 (mm)  
OD 2 : 313 (mm)  
ID 1 : 178 (mm)

CONT : 1  
VOL : 0.062

Note : Set Filter Uses A-8579-S(SOFT PU)

144

**A-8665M** Air Filter Primary Soft PU+Metal Element

SCANIA 1387548



Secondary Filter uses A-83090  
Set Filter uses A-86651M-S  
H 1 : 544 (mm)  
H 2 : 515 (mm)  
OD 1 : 308 (mm)  
OD 2 : 308 (mm)  
ID 1 : 177.5 (mm)

CONT : 1  
VOL : 0.060

Note : Is a Primary Air Filter of A-83090,A-8580

149

**A-8545** Air Filter Metal End Cap Element

ATLAS COPCO 1030-0979-000  
INTERNATIONAL HARVESTER 346779 R1  
INTERNATIONAL HARVESTER 346779 R91



H 1 : 368.2 (mm)  
H 2 : 355.5 (mm)  
OD 1 : 352 (mm)  
OD 2 : 352 (mm)  
ID 1 : 241 (mm)  
ID 2 : 13.5 (mm)

CONT : 1  
VOL : 0.056

Note : witout gaskets version uses A-6702

140

**A-8579M-S** Air Filter Set Soft PU+Metal Element

CATERPILLAR 142-1340+142-1403  
KOMATSU 600-185-6110+600-185-6120



Primary Filter uses A-8579M  
Secondary Filter uses A-8580  
H 1 : 521 (mm)  
H 2 : 510 (mm)  
OD 1 : 313 (mm)  
OD 2 : 313 (mm)  
ID 1 : 178 (mm)

CONT : 1  
VOL : 0.062

145

**A-8670** Air Filter Secondary Soft PU end cap Element

CASE 187472A1  
CASE 187472A2  
MASSEY-FERGUSON 4270036M1  
NEW HOLLAND (CNH) 8602996



Primary Filter uses A-8671  
Set Filter uses A-8672-S  
H 1 : 385 (mm)  
H 2 : 380 (mm)  
OD 1 : 107.5 (mm)  
OD 2 : 101.5 (mm)  
ID 1 : 89 (mm)

CONT : 25  
VOL : 0.152

150

# Sakura Filter

# Technical Specification

**A-92040** Air Filter Breather Metal End Cap Element



KOMATSU 20Y-60-21410  
KAWASAKI 30981-70330  
HYUNDAI 31EH-00480

H 1 : 33 (mm)  
H 2 : 26 (mm)  
OD 1 : 73 (mm)  
OD 2 : 73 (mm)  
ID 1 : 45 (mm)  
ID 2 : 45 (mm)

CONT : 100  
VOL : 0.025

Note : for Kawasaki Wheel Loader 70IV-2

**A-9218-S** Air Filter Set Metal End Cap Element



KOMATSU  
581-02-12120+581-02-12130  
EUCLID 9059562+9038349

Primary Filter uses A-9218  
Secondary Filter uses A-9205

H 1 : 596.75 (mm)  
H 2 : 584 (mm)  
OD 1 : 446.5 (mm)  
OD 2 : 468 (mm)  
ID 1 : 310 (mm)  
ID 2 : 23 (mm)

CONT : 1  
VOL : 0.148

**AS-1024** Air Filter Primary Metal End Cap Element With Sleeve



NISSAN 16546-96003  
NISSAN 16546-96015  
NISSAN 16546-96026

Secondary Filter uses A-6009  
Set Filter uses AS-1024-S

H 1 : 418.7 (mm)  
H 2 : 406 (mm)  
OD 1 : 254 (mm)  
OD 2 : 201.5 (mm)  
ID 1 : 135.5 (mm)  
ID 2 : 17 (mm)

CONT : 1  
VOL : 0.031

**A-9205** Air Filter Secondary Metal End Cap Element



CATERPILLAR 3I-0105  
KOMATSU 581-02-12130  
EUCLID 9038349

Primary Filter uses A-9218  
Set Filter uses A-9218-S

H 1 : 571.75 (mm)  
H 2 : 559 (mm)  
OD 1 : 301.5 (mm)  
OD 2 : 301.5 (mm)  
ID 1 : 260.5 (mm)  
ID 2 : 23 (mm)

CONT : 1  
VOL : 0.063

**A-9219** Air Filter Primary Metal End Cap Element



CATERPILLAR 3I-0801  
EUCLID 542380  
TEREX 9059570

Secondary Filter uses A-7966  
Set Filter uses A-9219-S

H 1 : 495.7 (mm)  
H 2 : 483 (mm)  
OD 1 : 447.5 (mm)  
OD 2 : 468 (mm)  
ID 1 : 309 (mm)  
ID 2 : 23 (mm)

CONT : 1  
VOL : 0.122

**AS-1024-S** Air Filter Set Metal End Cap Element With Sleeve



FIAT 1930751+1930790  
KOMATSU 6131-82-7011  
FIAT 70684732+1930790  
JOHN DEERE T46316+T46317

Primary Filter uses AS-1024  
Secondary Filter uses A-6009

H 1 : 418.7 (mm)  
H 2 : 406 (mm)  
OD 1 : 254 (mm)  
OD 2 : 201.5 (mm)  
ID 1 : 135.5 (mm)  
ID 2 : 17 (mm)

CONT : 1  
VOL : 0.031

**A-9217** Air Filter Primary Metal End Cap Element



CATERPILLAR 3I-0791  
EUCLID 6945659

Secondary Filter uses A-7902  
Set Filter uses A-9217-S

H 1 : 597.75 (mm)  
H 2 : 585 (mm)  
OD 1 : 447 (mm)  
OD 2 : 468 (mm)  
ID 1 : 281 (mm)  
ID 2 : 23 (mm)

CONT : 1  
VOL : 0.152

**A-9219-S** Air Filter Set Metal End Cap Element



EUCLID 9039992+9059570

Primary Filter uses A-9219  
Secondary Filter uses A-7966

H 1 : 495.7 (mm)  
H 2 : 483 (mm)  
OD 1 : 447.5 (mm)  
OD 2 : 468 (mm)  
ID 1 : 309 (mm)  
ID 2 : 23 (mm)

CONT : 1  
VOL : 0.122

**AS-1824** Air Filter Metal End Cap Element With Sleeve



YANMAR 129350-12900  
ISEKI 1480-104-2070-0  
NISSAN 16546-00H10

H 1 : 200 (mm)  
H 2 : 190 (mm)  
OD 1 : 131.5 (mm)  
OD 2 : 104 (mm)  
ID 1 : 63 (mm)  
ID 2 : 17 (mm)

CONT : 16  
VOL : 0.079

**A-9217-S** Air Filter Set Metal End Cap Element



EUCLID 6945659+6945658

Primary Filter uses A-9217  
Secondary Filter uses A-7902

H 1 : 597.75 (mm)  
H 2 : 585 (mm)  
OD 1 : 447 (mm)  
OD 2 : 468 (mm)  
ID 1 : 281 (mm)  
ID 2 : 23 (mm)

CONT : 1  
VOL : 0.148

**AS-1010** Air Filter Metal End Cap Element With Sleeve



ISUZU 14215-132  
CUMMINS 158876  
NISSAN 16546-Z5001

H 1 : 266.7 (mm)  
H 2 : 254 (mm)  
OD 1 : 257 (mm)  
OD 2 : 201.5 (mm)  
ID 1 : 90.5 (mm)  
ID 2 : 14 (mm)

CONT : 1  
VOL : 0.021

Note : INN.DIAM=91/17MM Version Uses AS-1025,  
INN.DIAM 116/13.5MM Version Uses AS-1037

**AS-2205** Air Filter Primary Metal End Cap Element With Sleeve



ISUZU 1-14215014-0  
YANMAR 121120-12901  
KUBOTA 121420-12511

Secondary Filter uses A-8568  
Set Filter uses AS-2206-S

H 1 : 264 (mm)  
H 2 : 254 (mm)  
OD 1 : 132 (mm)  
OD 2 : 104 (mm)  
ID 1 : 63 (mm)  
ID 2 : 17 (mm)

CONT : 12  
VOL : 0.073

**A-9218** Air Filter Primary Metal End Cap Element



CATERPILLAR 1W-3637  
CATERPILLAR 3I-0793  
KOMATSU 581-02-12120  
EUCLID 9059562

Secondary Filter uses A-9205  
Set Filter uses A-9218-S

H 1 : 596.75 (mm)  
H 2 : 584 (mm)  
OD 1 : 446.5 (mm)  
OD 2 : 468 (mm)  
ID 1 : 310 (mm)  
ID 2 : 23 (mm)

CONT : 1  
VOL : 0.148

**AS-1014** Air Filter Primary Metal End Cap Element With Sleeve



ISUZU 1-14215135-0  
TOYOTA 1001905  
YANMAR 171064-12540

Secondary Filter uses A-7919  
Set Filter uses AS-1014-S

H 1 : 288 (mm)  
H 2 : 279 (mm)  
OD 1 : 160 (mm)  
OD 2 : 134 (mm)  
ID 1 : 66.5 (mm)  
ID 2 : 17 (mm)

CONT : 9  
VOL : 0.090

**AS-5412** Air Filter Metal End Cap Element With Sleeve



YANMAR 124066-12510  
ISEKI 1427-101-2840-0  
KUBOTA 15221-11223

H 1 : 184.4 (mm)  
H 2 : 178 (mm)  
OD 1 : 109.4 (mm)  
OD 2 : 83 (mm)  
ID 1 : 45 (mm)  
ID 2 : 15.3 (mm)

CONT : 25  
VOL : 0.079



# Sakura Filter

# Technical Specification

**AS-5620** Air Filter Primary Metal End Cap Element With Sleeve

KOMATSU 600-181-7300



Secondary Filter uses A-5621  
Set Filter uses AS-5620-S  
H 1 : 290 (mm)  
H 2 : 280.5 (mm)  
OD 1 : 160 (mm)  
OD 2 : 134 (mm)  
ID 1 : 87 (mm)  
ID 2 : 17 (mm)

CONT : 9  
VOL : 0.090

166

**AS-5644-S** Air Filter Set Metal End Cap Element With Sleeve

KOMATSU 3EC-01-11630(SET)



Primary Filter uses AS-5644  
Secondary Filter uses A-7919  
H 1 : 288 (mm)  
H 2 : 279 (mm)  
OD 1 : 160 (mm)  
OD 2 : 181.5 (mm)  
ID 1 : 66.5 (mm)  
ID 2 : 17 (mm)

CONT : 12  
VOL : 0.163

171

**AS-7609** Air Filter Primary Metal End Cap Element With Sleeve

CATERPILLAR 3I-0228  
FIAT 79022025



Secondary Filter uses A-7605  
Set Filter uses AS-7609-S  
H 1 : 315.9 (mm)  
H 2 : 305 (mm)  
OD 1 : 160 (mm)  
OD 2 : 133.5 (mm)  
ID 1 : 82 (mm)  
ID 2 : 17 (mm)

CONT : 9  
VOL : 0.110

176

**AS-5628** Air Filter Primary Metal End Cap Element With Sleeve

MAZDA 0727-23-603  
ISUZU 1-14215028-0  
ISUZU 1-14215032-0



Secondary Filter uses A-7611  
Set Filter uses AS-5628-S  
H 1 : 311 (mm)  
H 2 : 305 (mm)  
OD 1 : 199.3 (mm)  
OD 2 : 155 (mm)  
ID 1 : 88 (mm)  
ID 2 : 17 (mm)

CONT : 12  
VOL : 0.194

167

**AS-5670** Air Filter Primary Metal End Cap Element With Sleeve

KOMATSU 205-01-73570  
KOMATSU 205-01-73750



Secondary Filter uses A-5671  
Set Filter uses AS-5672-S  
H 1 : 452.75 (mm)  
H 2 : 440 (mm)  
OD 1 : 278.5 (mm)  
OD 2 : 201.5 (mm)  
ID 1 : 135 (mm)

CONT : 1  
VOL : 0.040

172

**AS-7805** Air Filter Primary Metal End Cap Element With Sleeve

IVECO 08014390  
MASSEY-FERGUSON 1093682M91  
ISUZU 14215-166



Secondary Filter uses A-7806  
Set Filter uses AS-5656-S  
H 1 : 392 (mm)  
H 2 : 381 (mm)  
OD 1 : 199 (mm)  
OD 2 : 155 (mm)  
ID 1 : 88 (mm)  
ID 2 : 17 (mm)

Gasket Type : Square

CONT : 9  
VOL : 0.169

Note : Long Life Versions Uses AS-7813

177

**AS-5643** Air Filter Primary Metal End Cap Element With Sleeve

KOMATSU 37Z-02-AF934A  
KOMATSU 3EA-01-18130  
HITACHI 4294846



Secondary Filter uses A-8568  
Set Filter uses AS-5643-S  
H 1 : 263.7 (mm)  
H 2 : 251 (mm)  
OD 1 : 131.5 (mm)  
OD 2 : 148 (mm)  
ID 1 : 63 (mm)  
ID 2 : 17 (mm)

CONT : 16  
VOL : 0.121

168

**AS-5672-S** Air Filter Set Metal End Cap Element With Sleeve

KOMATSU  
205-01-73570+205-01-K1480



Primary Filter uses AS-5670  
Secondary Filter uses A-5671  
H 1 : 440 (mm)  
H 2 : 407 (mm)  
OD 1 : 278.5 (mm)  
OD 2 : 201.5 (mm)  
ID 1 : 135 (mm)

CONT : 1  
VOL : 0.040

173

**AS-7988** Air Filter Primary Metal End Cap Element With Sleeve

YANMAR 119131-12530  
FIAT-ALLIS 1930765  
KOMATSU 203-01-K1130



Secondary Filter uses A-7964  
Set Filter uses AS-7988-S  
H 1 : 393.75 (mm)  
H 2 : 381 (mm)  
OD 1 : 200 (mm)  
OD 2 : 216.5 (mm)  
ID 1 : 88 (mm)  
ID 2 : 17 (mm)

CONT : 4  
VOL : 0.091

178

**AS-5643-S** Air Filter Set Metal End Cap Element With Sleeve

CASE 167815A1+167817A1  
KOMATSU  
3EA-01-18130+3EB-02-19840  
HITACHI 4294846+4311871  
J.C.BAMFORD KAP0482+KAP0727



Primary Filter uses AS-5643  
Secondary Filter uses A-8568  
H 1 : 263.7 (mm)  
H 2 : 251 (mm)  
OD 1 : 131.5 (mm)  
OD 2 : 148 (mm)  
ID 1 : 63 (mm)  
ID 2 : 17 (mm)

CONT : 16  
VOL : 0.121

169

**AS-5706** Air Filter Metal End Cap Element With Sleeve

CUMMINS 158879  
NISSAN 16546-90112  
CUMMINS 299346



H 1 : 368.25 (mm)  
H 2 : 355.5 (mm)  
OD 1 : 402.6 (mm)  
OD 2 : 307.2 (mm)  
ID 1 : 196 (mm)  
ID 2 : 13.5 (mm)

CONT : 1  
VOL : 0.070

174

**AS-8502** Air Filter Primary Metal End Cap Element With Sleeve

FURUKAWA 1129111C1



Secondary Filter uses A-5437  
Set Filter uses AS-8502-S  
H 1 : 392 (mm)  
H 2 : 381 (mm)  
OD 1 : 225 (mm)  
OD 2 : 174 (mm)  
ID 1 : 107.5 (mm)  
ID 2 : 17 (mm)

CONT : 4  
VOL : 0.107

179

**AS-5644** Air Filter Primary Metal End Cap Element With Sleeve

YANMAR 119005-12510  
KOBELCO 2446U271S2  
MITSUBISHI 32A3005300



Secondary Filter uses A-7919  
Set Filter uses AS-5644-S  
H 1 : 288 (mm)  
H 2 : 279 (mm)  
OD 1 : 160 (mm)  
OD 2 : 181.5 (mm)  
ID 1 : 66.5 (mm)  
ID 2 : 17 (mm)

CONT : 12  
VOL : 0.154

170

**AS-5707** Air Filter Metal End Cap Element With Sleeve

CUMMINS 158871  
CUMMINS 158878  
NISSAN 16546-M0800



H 1 : 317.7 (mm)  
H 2 : 305 (mm)  
OD 1 : 352 (mm)  
OD 2 : 282 (mm)  
ID 1 : 171 (mm)  
ID 2 : 13.5 (mm)

CONT : 1  
VOL : 0.046

175

**AS-8502-S** Air Filter Set Metal End Cap Element With Sleeve

FURUKAWA 1129111C1+1129112C1



Primary Filter uses AS-8502  
Secondary Filter uses A-5437  
H 1 : 392 (mm)  
H 2 : 381 (mm)  
OD 1 : 225 (mm)  
OD 2 : 174 (mm)  
ID 1 : 107.5 (mm)  
ID 2 : 17 (mm)

CONT : 4  
VOL : 0.101

180

# Sakura Filter

# Technical Specification

**AS-8801** Air Filter Primary Metal End Cap Element With Sleeve

YANMAR 119860-12510  
KUBOTA 15852-11011  
KUBOTA 15852-11080



H 1 : 185 (mm)  
H 2 : 177 (mm)  
OD 1 : 83 (mm)  
OD 2 : 128.5 (mm)  
ID 1 : 45 (mm)  
ID 2 : 9 (mm)

CONT : 12  
VOL : 0.052

181

**C-1720** Oil Filter Full Flow Spin-On

TCM 12163-82302  
YANMAR 129150-35152



H 1 : 100 (mm)  
OD 1 : 90 (mm)  
Thread Size : M20X1.5-6H  
BPV (kg/cm2) : 1.0  
ADBV : YES  
Gasket Type : Round

CONT : 36  
VOL : 0.040

186

**C-1834** Oil Filter Full Flow Spin-On

NISSAN 15208-W3401



H 1 : 130 (mm)  
OD 1 : 93 (mm)  
Thread Size : 3/4-16 UNF-2B  
Gasket Type : Square

CONT : 36  
VOL : 0.051

Note : Round Version Uses C-1803

191

**C-1011** Oil Filter Full Flow Spin-On

JAC 1017100GG010  
NISSAN 15208-HC400  
HINO 15607-1920  
MAZDA JEYO-14-302



H 1 : 85 (mm)  
OD 1 : 68 (mm)  
Thread Size : M20X1.5-6H  
BPV (kg/cm2) : 1.0  
ADBV : YES  
Gasket Type : Round

CONT : 50  
VOL : 0.026

Note : Square version uses C-1030

182

**C-1803** Oil Filter Full Flow Spin-On

NISSAN 15208-65010  
NISSAN 15208-65011  
NISSAN 15208-65014



H 1 : 129 (mm)  
OD 1 : 93 (mm)  
Thread Size : 3/4-16 UNF-2B  
ADBV : YES  
Gasket Type : Round

CONT : 50  
VOL : 0.073

Note : Square Version Uses C-1834

187

**C-1914** Oil Filter Full Flow Spin-On

ALLIS CHALMERS 0230578-1  
ALFA ROMEO 119003206101  
GENERAL MOTORS 7984303



H 1 : 140 (mm)  
OD 1 : 93 (mm)  
Thread Size : 3/4-16 UNF-2B  
BPV (kg/cm2) : 1.0  
ADBV : YES  
Gasket Type : Square

CONT : 16  
VOL : 0.033

192

**C-1122** Oil Filter Full Flow Spin-On

TOYOTA 00120-00005  
TOYOTA 00120-00007  
VW GROUP 021 115 351A  
PORSCHE 021.115.351  
PORSCHE 021.115.351A



H 1 : 95 (mm)  
OD 1 : 93 (mm)  
Thread Size : 3/4-16 UNF-2B  
BPV (kg/cm2) : 1.0  
ADBV : YES  
Gasket Type : Square

CONT : 12  
VOL : 0.014

183

**C-1807** Oil Filter Full Flow Spin-On

NISSAN 15209-76200  
NISSAN 15209-76201  
NISSAN 15209-C8600



H 1 : 174 (mm)  
OD 1 : 93 (mm)  
Thread Size : 1-12 UNF-2B  
ADBV : YES  
Gasket Type : Round

CONT : 12  
VOL : 0.023

Note : Square version uses C-1837

188

**C-1920** Oil Filter Full Flow Spin-On

MAZDA 0000-23-8173  
MAZDA 0813-23-802  
MAZDA 0839-14-300  
MAZDA 0866-23-803  
NISSAN 152087B000



H 1 : 120 (mm)  
OD 1 : 76 (mm)  
Thread Size : M20X1.5-6H  
BPV (kg/cm2) : 1.0  
ADBV : YES  
Gasket Type : Square

CONT : 50  
VOL : 0.043

193

**C-1140** Oil Filter Full Flow Spin-On

TOYOTA 90915-03004  
TOYOTA 90915-10002  
TOYOTA 90915-YZZE2



H 1 : 85 (mm)  
OD 1 : 65 (mm)  
Thread Size : 3/4-16 UNF-2B  
BPV (kg/cm2) : 1.0  
ADBV : YES  
Gasket Type : Round

CONT : 50  
VOL : 0.027

184

**C-1828** Oil Filter Full Flow Spin-On

FORDFINISCODE 5007124



H 1 : 120 (mm)  
OD 1 : 76 (mm)  
Thread Size : 3/4-16 UNF-2B  
BPV (kg/cm2) : 1.4 - 1.6  
ADBV : YES  
Gasket Type : Square

CONT : 50  
VOL : 0.043

189

**C-2302** Oil Filter Full Flow Spin-On

FORD 000-6731G  
CHRYSLER 2196909  
AMERICAN MOTORS 3157847  
AMERICAN MOTORS 3177601  
AMERICAN MOTORS 3177757



H 1 : 130 (mm)  
OD 1 : 93 (mm)  
Thread Size : 13/16-16 UNF-2B  
Gasket Type : Square

CONT : 36  
VOL : 0.051

Note : Supersedes C-8002

194

**C-1305** Oil Filter Full Flow Spin-On

ISUZU 1-13240046-1  
ISUZU 1-13240061-0  
ISUZU 1-13240075-0



H 1 : 199 (mm)  
OD 1 : 110 (mm)  
Thread Size : 1 1/2-12 UNF-2B  
Gasket Type : Square

CONT : 12  
VOL : 0.036

Note : Without Nut

185

**C-1829** Oil Filter Full Flow Spin-On

GENERAL MOTORS 12339994  
NISSAN 13210-13211  
NISSAN 13212-13213  
NISSAN 15208-01B15  
NISSAN 15208-55Y00



H 1 : 105 (mm)  
OD 1 : 76 (mm)  
Thread Size : 3/4-16 UNF-2B  
ADBV : YES  
Gasket Type : Square

CONT : 50  
VOL : 0.038

190

**C-5102** Oil Filter Full Flow Spin-On

PERKINS 26540347  
PERKINS 2654407



H 1 : 168 (mm)  
OD 1 : 93 (mm)  
Thread Size : 3/4-16 UNF-2B  
BPV (kg/cm2) : 1.0  
ADBV : YES  
Gasket Type : Square

CONT : 25  
VOL : 0.050

195

# Sakura Filter

# Technical Specification

**C-5204** Oil Filter Full Flow Spin-On

YANMAR 119005-35100  
YANMAR 16271-32091  
YANMAR Y119005-35100



H 1 : 100 (mm)  
OD 1 : 80 (mm)  
Thread Size : M20X1.5-6H  
BPV (kg/cm2) : 1.0  
ADBV : YES  
Gasket Type : Round

CONT : 50  
VOL : 0.045

196

**C-5516** Oil Filter Full Flow Spin-On

CATERPILLAR 1R-0716



H 1 : 286 (mm)  
OD 1 : 118 (mm)  
Thread Size : 1 1/2-16 UN-2B  
Gasket Type : Square

CONT : 6  
VOL : 0.036

201

**C-5608** Oil Filter Full Flow Spin-On

KOMATSU 6134-51-5120  
KOMATSU 6134-51-5121



H 1 : 166 (mm)  
OD 1 : 108 (mm)  
Thread Size : 1 1/8-16 UNF-2B  
ADBV : YES  
Gasket Type : Square

CONT : 12  
VOL : 0.034

206

**C-5205** Oil Filter Full Flow Spin-On

YANMAR 119305-35151



H 1 : 65 (mm)  
OD 1 : 65 (mm)  
Thread Size : M20X1.5-6H  
BPV (kg/cm2) : 1.0  
ADBV : YES  
Gasket Type : Round

CONT : 50  
VOL : 0.036

197

**C-5523** Oil Filter Full Flow Spin-On With Microfiber media

CATERPILLAR 2P-4005



H 1 : 304 (mm)  
OD 1 : 136 (mm)  
Thread Size : 1 1/2-16 UN-2B  
Gasket Type : Square

CONT : 6  
VOL : 0.050

202

**C-5610** Oil Filter Full Flow Spin-On Cellulose media

DAEWOO 65055105028  
KOMATSU 6736-51-5141



H 1 : 174.4 (mm)  
OD 1 : 93 (mm)  
Thread Size : 1-16 UNF-2B  
ADBV : YES  
Gasket Type : Square

CONT : 12  
VOL : 0.027

Note : C-5610 cellulose media,C-5611 syntetic media

207

**C-5402** Oil Filter Full Flow Spin-On

INTERNATIONAL HARVESTER 684206 C1  
INTERNATIONAL HARVESTER 684206 C2



H 1 : 246 (mm)  
OD 1 : 136 (mm)  
Thread Size : 1 1/2-16 UN-2B  
Gasket Type : Square

CONT : 6  
VOL : 0.041

198

**C-5604** Oil Filter Full Flow Spin-On

KOMATSU 600-211-6240  
KOMATSU 600-211-6241



H 1 : 98 (mm)  
OD 1 : 93 (mm)  
Thread Size : 1-12 UNF-2B  
BPV (kg/cm2) : 1.0  
ADBV : YES  
Gasket Type : Round

CONT : 12  
VOL : 0.016

Note : Square Type Height 84 MM Used With C-5615,Round Type Height 84 MM Uses C-5616

203

**C-5611** Oil Filter Full Flow Spin-On Synthetic Media

CUMMINS 3977910  
KOMATSU 6736-51-5142



H 1 : 174.4 (mm)  
OD 1 : 93 (mm)  
Thread Size : 1-16 UNF-2B  
ADBV : YES  
Gasket Type : Square

CONT : 12  
VOL : 0.027

Note : C-5610 cellulose media,C-5611 syntetic media

208

**C-5405** Oil Filter Full Flow Spin-On

INTERNATIONAL HARVESTER 3136046R93  
MC CORMICK (LANDINI-ARGO) MC3136046R93



H 1 : 108 (mm)  
OD 1 : 93 (mm)  
Thread Size : 1-12 UNF-2B  
BPV (kg/cm2) : 1.0  
Gasket Type : Square

CONT : 24  
VOL : 0.029

199

**C-5605** Oil Filter Full Flow Spin-On

MITSUBISHI 32540-01601  
MITSUBISHI 37438-02700  
MITSUBISHI 37540-01101



H 1 : 262 (mm)  
OD 1 : 108 (mm)  
Thread Size : 1 1/2-12 UNF-2B  
Gasket Type : Square

CONT : 10  
VOL : 0.039

204

**C-5614** Oil Filter Full Flow Spin-On

MITSUBISHI 32540-21600  
KOMATSU 6136-51-5120  
KOMATSU 6136-51-5121



H 1 : 166 (mm)  
OD 1 : 108 (mm)  
Thread Size : 1 1/8-16 UNF-2B  
BPV (kg/cm2) : 2.0  
Gasket Type : Square

CONT : 12  
VOL : 0.035

209

**C-5505** Oil Filter Full Flow Spin-On

CATERPILLAR 1R-0714  
HITACHI 4429728  
FIAT 71455273  
MITSUBISHI ME034878  
MITSUBISHI ME088519



H 1 : 162 (mm)  
OD 1 : 108 (mm)  
Thread Size : 1 1/8-16 UNF-2B  
Gasket Type : Square

CONT : 12  
VOL : 0.034

200

**C-5606** Oil Filter Full Flow Spin-On

KOMATSU 600-211-5242



H 1 : 136 (mm)  
OD 1 : 93 (mm)  
Thread Size : 1-12 UNF-2B  
ADBV : YES  
Gasket Type : Square

CONT : 12  
VOL : 0.021

205

**C-5615** Oil Filter Full Flow Spin-On

KOMATSU 600-211-6242



H 1 : 86 (mm)  
OD 1 : 93 (mm)  
Thread Size : 1-12 UNF-2B  
ADBV : YES  
Gasket Type : Square

CONT : 12  
VOL : 0.015

Note : Round Type Used With C-5604

210

**C-5616** Oil Filter Full Flow Spin-On  
KOMATSU 600-211-6242



H 1 : 84 (mm)  
OD 1 : 93 (mm)  
Thread Size : 1-12 UNF-2B  
BPV (kg/cm2) : 1.0  
ADBV : YES  
Gasket Type : Round

CONT : 25  
VOL : 0.036

Note : C-5604 (Height difference)

**C-5707** Oil Filter Combination Spin-On Seamless  
J.C.BAMFORD 02/910965  
CUMMINS 3401544  
KOMATSU 6742-01-4540



H 1 : 294 (mm)  
OD 1 : 118 (mm)  
Thread Size : 2 1/4-12 UNF-2B

CONT : 6  
VOL : 0.029

Note : Multilayer

**C-5715** Oil Filter Full Flow Spin-On  
MTU 0031843001  
CUMMINS 3313279  
MITSUBISHI 37540-01101  
CUMMINS 3889310  
KOMATSU CULF-670



H 1 : 246 (mm)  
OD 1 : 118 (mm)  
Thread Size : 1 1/2-12 UNF-2B

CONT : 6  
VOL : 0.029

Note : Height 286 MM Uses C-5701

**C-56190** Oil Filter Full Flow Spin-On  
KOMATSU 600-211-2110



H 1 : 80 (mm)  
OD 1 : 74 (mm)  
Thread Size : 3/4-16 UNF-2B  
BPV (kg/cm2) : 2.0 - 2.5  
ADBV : YES  
Gasket Type : Round

CONT : 50  
VOL : 0.036

Note : C-56191(bottom plate difference)

**C-5708** Oil Filter Full Flow Spin-On  
J.C.BAMFORD 32/925413  
CUMMINS 3937736



H 1 : 174 (mm)  
OD 1 : 93 (mm)  
Thread Size : 1 1/8-16 UNF-2B  
Gasket Type : Square

CONT : 12  
VOL : 0.027

Note : Glass Fiber media uses C-5733

**C-5718** Oil Filter By Pass Spin-On  
ISUZU 1-87310093-0  
CATERPILLAR 1W-8845  
J.C.BAMFORD 32/919502  
HITACHI 4285964



H 1 : 246 (mm)  
OD 1 : 115.5 (mm)  
Thread Size : 1 3/8-16 UNF-2B

CONT : 6  
VOL : 0.032

**C-56191** Oil Filter Full Flow Spin-On long life  
KOMATSU 600-211-2110  
CASE 87409203  
NEW HOLLAND (CNH) 87415600  
CUMMINS C6002112110



H 1 : 86.5 (mm)  
OD 1 : 76 (mm)  
Thread Size : 3/4-16 UNF-2B  
BPV (kg/cm2) : 1.0  
ADBV : YES  
Gasket Type : Square

CONT : 36  
VOL : 0.032

Note : C-56190(bottom plate difference)

**C-5710** Oil Filter Combination Spin-On Seamless  
HYUNDAI 11NB-70110  
CUMMINS 2882674  
CUMMINS 3101869  
LIUGONG 40C0434  
KOMATSU 600-211-1340



H 1 : 299 (mm)  
OD 1 : 118 (mm)  
Thread Size : M95X2.5-7H

CONT : 6  
VOL : 0.033

Note : Performance Grade Uses C-5724,C-57430

**C-5723** Oil Filter Combination Spin-On  
KOMATSU 6742-01-4120



H 1 : 280 (mm)  
OD 1 : 121 (mm)  
Thread Size : 2 1/4-12 UNF-2B  
Gasket Type : Square

CONT : 6  
VOL : 0.038

Note : C-5723 is upgrade version of C-5706

**C-5701** Oil Filter Full Flow Spin-On  
HITACHI 4085913  
KOMATSU 600-211-1231



H 1 : 286 (mm)  
OD 1 : 118 (mm)  
Thread Size : 1 1/2-12 UNF-2B  
Gasket Type : Square

CONT : 10  
VOL : 0.055

Note : related to:C-5605,C-5731,C-5715(short versions)

**C-5712** Oil Filter Full Flow Spin-On  
KOMATSU 6732-51-5141



H 1 : 145 (mm)  
OD 1 : 93 (mm)  
Thread Size : 1-16 UNF-2B  
ADBV : YES  
Gasket Type : Square

CONT : 12  
VOL : 0.023

**C-5730** Oil Filter Full Flow Spin-On Synthetic Media  
CUMMINS 3903264  
VOLVO 9912-90710



H 1 : 174 (mm)  
OD 1 : 93 (mm)  
Thread Size : 1-16 UNF-2B  
Gasket Type : Square

CONT : 12  
VOL : 0.030

**C-5703** Oil Filter Full Flow Spin-On  
HYUNDAI 11E1-70110  
GENERAL MOTORS 25011995  
CUMMINS 3903224  
KOMATSU 6732-51-5140  
CASE J908616



H 1 : 135 (mm)  
OD 1 : 93 (mm)  
Thread Size : 1-16 UNF-2B  
Gasket Type : Square

CONT : 12  
VOL : 0.018

**C-5713** Oil Filter Full Flow Spin-On Synthetic Media  
CUMMINS 4897898  
CASE 87803261  
FOTON C4897898A0571A



H 1 : 172 (mm)  
OD 1 : 93.5 (mm)  
Thread Size : M27X2-6H  
Gasket Type : Square

CONT : 12  
VOL : 0.026

Note : C-5734(Economical type of C-5713)

**C-5731** Oil Filter Full Flow Spin-On With Microfiber media  
CUMMINS 299670



H 1 : 260 (mm)  
OD 1 : 118 (mm)  
Thread Size : 1 1/2-12 UNF-2B  
Gasket Type : Square

CONT : 6  
VOL : 0.031

# Sakura Filter

# Technical Specification

**C-57390** Oil Filter Combination Spin-On Synthetic Media

CUMMINS 3973686  
CASE 87349575



H 1 : 234 (mm)  
OD 1 : 118 (mm)  
Thread Size : 2 1/4-12 UNF-2B

CONT : 6  
VOL : 0.030

226

**C-6204** Oil Filter Full Flow Spin-On

MERCEDES-BENZ 001 184 96 01  
DEUTZ 1173430  
CATERPILLAR 5W-6017  
ALLIS CHALMERS 61671600  
EVOBUS 7.119.226.04



H 1 : 206 (mm)  
OD 1 : 93 (mm)  
Thread Size : 1-12 UNF-2B  
BPV (kg/cm2) : 2.0 - 2.5  
ADBV : YES  
Gasket Type : Square

CONT : 25  
VOL : 0.057

Note : With Grip

231

**C-8012** Oil Filter Full Flow Spin-On

MAHINDRA 14501673990  
HITACHI 26300-21010  
HYUNDAI 26300-21010  
CHRYSLER 4186267  
MITSUBISHI 4253037



H 1 : 78 (mm)  
OD 1 : 86 (mm)  
Thread Size : M20X1.5-6H  
BPV (kg/cm2) : 1.0  
ADBV : YES  
Gasket Type : Square

CONT : 36  
VOL : 0.036

236

**C-57430** Oil Filter Full Flow Spin-On Synthetic Media

CUMMINS 4367100  
KOMATSU 600-211-1340



H 1 : 300 (mm)  
OD 1 : 118 (mm)  
Thread Size : M95X2.5-7H

CONT : 6  
VOL : 0.035

Note : upgrade of C-5710,C-5724

227

**C-6210** Oil Filter Full Flow Spin-On

VOLVO 423135-8



H 1 : 169 (mm)  
OD 1 : 93 (mm)  
Thread Size : 1-12 UNF-2B  
BPV (kg/cm2) : 1.0  
Gasket Type : Square

CONT : 12  
VOL : 0.023

232

**C-8016** Oil Filter Full Flow Spin-On

OPEL 650352  
RENAULT 7 700 638 670  
FORD 741M-6714-BA



H 1 : 87 (mm)  
OD 1 : 76 (mm)  
Thread Size : 3/4-16 UNF-2B  
Gasket Type : Square

CONT : 50  
VOL : 0.034

237

**C-5814** Oil Filter Full Flow Spin-On

MITSUBISHI 34740-00100



H 1 : 167 (mm)  
OD 1 : 93 (mm)  
Thread Size : 1-12 UNF-2B  
ADBV : YES  
Gasket Type : Round

CONT : 12  
VOL : 0.026

228

**C-7005** Oil Filter Full Flow Spin-On

GENERAL MOTORS 25010971  
CATERPILLAR 773899



H 1 : 260 (mm)  
OD 1 : 122 (mm)  
Thread Size : 1 1/2-12 UNF-2B  
Gasket Type : Square

CONT : 6  
VOL : 0.035

233

**C-8031** Oil Filter Full Flow Spin-On

CLARK 152499  
CUMMINS 152499  
CUMMINS 170200



H 1 : 139 (mm)  
OD 1 : 93 (mm)  
Thread Size : 13/16-16 UNF-2B  
BPV (kg/cm2) : 1.0  
Gasket Type : Square

CONT : 25  
VOL : 0.052

238

**C-6202** Oil Filter Full Flow Spin-On

DEMAG 206 089 40  
RENAULT 60 05 024 443



H 1 : 140 (mm)  
OD 1 : 93 (mm)  
Thread Size : 1-12 UNF-2B  
BPV (kg/cm2) : 1.0  
Gasket Type : Square

CONT : 25  
VOL : 0.041

Note : Without Nut

229

**C-7602** Oil Filter Full Flow Spin-On

STEIGER 18842  
DEMAG 25577440  
CLARK 6519239  
CASE A41725  
JOHN DEERE AR43634



H 1 : 174 (mm)  
OD 1 : 127 (mm)  
Thread Size : 1 1/2-16 UN-2B  
Gasket Type : Square

CONT : 6  
VOL : 0.025

234

**CA-5601-S** Cabin Air Filter Set Plastic framed Element

KOMATSU 77Z-97-00020



H 1 : 19.5 (mm)  
Length 1 : 303.5 (mm)  
Width 1 : 199 (mm)

CONT : 20  
VOL : 0.036

Note : 1 set= 3 pcs filter

239

**C-6203** Oil Filter Full Flow Spin-On

IVECO 1161934  
IVECO 1902136



H 1 : 169 (mm)  
OD 1 : 93 (mm)  
Thread Size : 1-12 UNF-2B  
BPV (kg/cm2) : 1.0  
Gasket Type : Square

CONT : 25  
VOL : 0.030

230

**C-7927** Oil Filter Combination Spin-On

KOMATSU CULF 3548  
CASE J919562



H 1 : 238 (mm)  
OD 1 : 121 (mm)  
Thread Size : 2 1/4-12 UNF-2B  
Gasket Type : Square

CONT : 6  
VOL : 0.030

235

**CA-5602** Cabin Air Filter Plastic framed Element

KOMATSU 20Y-979-6261



H 1 : 19.7 (mm)  
Length 1 : 266 (mm)  
Width 1 : 142 (mm)

CONT : 20  
VOL : 0.023

240

# Sakura Filter

# Technical Specification

**CA-5603-S** Cabin Air Filter Set Plastic framed Element  
 KOMATSU 14X-911-7741  
 KOMATSU 77Z-97-00010



H 1 : 19.5 (mm)  
 Length 1 : 202.5 (mm)  
 Width 1 : 199 (mm)

CONT : 20  
 VOL : 0.024

Note : 1 set= 2 pcs filter

**CA-56120** Cabin Air Filter Paper framed Element  
 KOMATSU 2A5-979-1551



H 1 : 29 (mm)  
 Length 1 : 203.5 (mm)  
 Width 1 : 218.6 (mm)

CONT : 20  
 VOL : 0.045

Note : For Carbon type please check CAC number.

**CAC-56120** Cabin Air Filter Paper framed Element with activated charcoal  
 KOMATSU 2A5-979-1551

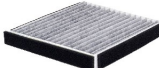

H 1 : 29 (mm)  
 Length 1 : 203.5 (mm)  
 Width 1 : 218.6 (mm)

CONT : 20  
 VOL : 0.051

Note : For Standard type please check CA number.

**CA-56041** Cabin Air Filter Plastic framed Element  
 KOMATSU 14X-911-7750  
 KOMATSU 17M-911-3530  
 HITACHI 4234793  
 KOMATSU 569-076-1190  
 FIAT 71498266



H 1 : 51 (mm)  
 Length 1 : 220 (mm)  
 Width 1 : 163 (mm)

CONT : 20  
 VOL : 0.049

**CA-56130** Cabin Air Filter Plastic Element  
 KOMATSU 114-X11-3850



H 1 : 26.5 (mm)  
 Length 1 : 236.5 (mm)  
 Width 1 : 201 (mm)

CONT : 20  
 VOL : 0.047

**F-1303** Fuel Filter Metal End Cap Element  
 ISUZU 13240-029  
 NISSAN 16403-90026  
 NISSAN 16444-90000  
 HINO 23401-1030



H 1 : 105 (mm)  
 OD 1 : 74 (mm)  
 OD 2 : 74 (mm)  
 ID 1 : 16 (mm)  
 ID 2 : 16 (mm)

CONT : 50  
 VOL : 0.040

**CA-56070** Cabin Air Filter Paper framed Element  
 KOMATSU 203-979-6840



H 1 : 24 (mm)  
 Length 1 : 306 (mm)  
 Length 2 : 236 (mm)  
 Width 1 : 198 (mm)

CONT : 20  
 VOL : 0.047

**CA-56140** Cabin Air Filter Recirculation Foam Element  
 KOMATSU EM0055



H 1 : 12 (mm)  
 Length 1 : 488 (mm)  
 Width 1 : 88 (mm)

CONT : 50  
 VOL : 0.031

**F-1501** Fuel Filter Metal End Cap Element  
 NISSAN 16403-37000  
 NISSAN 16403-37225  
 ISUZU 5-87810005-0



H 1 : 57 (mm)  
 OD 1 : 74 (mm)  
 OD 2 : 74 (mm)  
 ID 1 : 16 (mm)  
 ID 2 : 16 (mm)

CONT : 24  
 VOL : 0.012

**CA-56080** Cabin Air Filter Plastic framed Element  
 KOMATSU 208-979-7740



H 1 : 19.5 (mm)  
 Length 1 : 199 (mm)  
 Width 1 : 101.5 (mm)

CONT : 20  
 VOL : 0.013

**CA-56150** Cabin Air Filter Metal framed Element  
 KOMATSU 23B-950-2170  
 KOMATSU 23B-950-2171

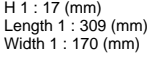

H 1 : 17 (mm)  
 Length 1 : 309 (mm)  
 Width 1 : 170 (mm)

CONT : 25  
 VOL : 0.056

**F-1801** Fuel Filter Metal End Cap Element  
 NISSAN 16444-90001  
 NISSAN 16444-90026  
 NISSAN 16444-90127



H 1 : 143 (mm)  
 H 2 : 140 (mm)  
 OD 1 : 91.5 (mm)  
 OD 2 : 91.5 (mm)  
 ID 1 : 15 (mm)  
 ID 2 : 15 (mm)

CONT : 50  
 VOL : 0.073

**CA-56100** Cabin Air Filter Metal framed Element  
 KOMATSU 209-97-96260  
 KOMATSU 421-07-12312



H 1 : 55.8 (mm)  
 Length 1 : 253.5 (mm)  
 Width 1 : 153 (mm)

CONT : 20  
 VOL : 0.057

**CA-5676** Cabin Air Filter Soft PU framed Element  
 KOMATSU 426-07-32441  
 KOMATSU 427-07-22120



H 1 : 46 (mm)  
 Length 1 : 312 (mm)  
 Width 1 : 255 (mm)

CONT : 20  
 VOL : 0.092

**F-2601** Fuel Filter Metal End Cap Element  
 MERCEDES-BENZ 1457431261  
 IVECO 190605  
 DAEWOO 65.12503-5003



H 1 : 113 (mm)  
 H 2 : 107 (mm)  
 OD 1 : 64 (mm)  
 OD 2 : 64 (mm)  
 ID 1 : 12.8 (mm)  
 ID 2 : 12.8 (mm)

CONT : 50  
 VOL : 0.035

Note : Paper Protector

**F-2603** Fuel Filter Metal End Cap Element

MERCEDES-BENZ 000 477 31 15  
DAIMLER BENZ 4220900051  
STEYR-DAIMLER-PUCH 614080740



H 1 : 145 (mm)  
H 2 : 130 (mm)  
OD 1 : 84.5 (mm)  
OD 2 : 84.5 (mm)  
ID 1 : 13 (mm)  
ID 2 : 13 (mm)

CONT : 50  
VOL : 0.062

256

**F-5207** Fuel Filter Metal End Cap Element

YANMAR 119810-55650  
YANMAR 124550-55700  
KUBOTA 16271-43560



H 1 : 87.5 (mm)  
H 2 : 85 (mm)  
OD 1 : 35 (mm)  
OD 2 : 35 (mm)  
ID 1 : 11.5 (mm)

CONT : 50  
VOL : 0.009

261

**F-5601** Fuel Filter Metal End Cap Element

KOMATSU 6610-72-8600



H 1 : 235 (mm)  
H 2 : 235 (mm)  
OD 1 : 126 (mm)  
OD 2 : 126 (mm)  
ID 1 : 25 (mm)  
ID 2 : 25 (mm)

CONT : 20  
VOL : 0.110

Note : Hanger, Paper Protector

266

**F-2604** Fuel Filter Metal End Cap Element

MERCEDES-BENZ 000 477 40 15  
MERCEDES-BENZ 000 477 45 15  
MERCEDES-BENZ 355 470 01 92



H 1 : 145 (mm)  
H 2 : 138 (mm)  
OD 1 : 83 (mm)  
OD 2 : 83 (mm)  
ID 1 : 14 (mm)  
ID 2 : 14 (mm)

CONT : 50  
VOL : 0.062

257

**F-5210** Fuel Filter Metal End Cap Element

YANMAR 129100-55650  
KUBOTA 15521-43160  
KUBOTA 607



H 1 : 89 (mm)  
OD 1 : 50 (mm)  
OD 2 : 50 (mm)  
ID 1 : 20 (mm)

CONT : 50  
VOL : 0.017

262

**F-56040** Fuel Filter Metal End Cap Element

KOMATSU 600-311-9971



H 1 : 42 (mm)  
H 2 : 38.5 (mm)  
OD 1 : 60 (mm)  
OD 2 : 50 (mm)  
ID 1 : 37 (mm)  
ID 2 : 37 (mm)

CONT : 50  
VOL : 0.015

267

**F-2622** Fuel Filter Metal End Cap Element

MERCEDES-BENZ 4773815  
DAEWOO 65125035001  
CASE 714401R92  
CLAAS 99104



H 1 : 112 (mm)  
H 2 : 102 (mm)  
OD 1 : 69 (mm)  
OD 2 : 69 (mm)  
ID 1 : 19 (mm)  
ID 2 : 19 (mm)

CONT : 50  
VOL : 0.034

258

**F-5214** Fuel Filter Metal End Cap Element

YANMAR 171081-55910  
CASE 282211A1  
ISUZU 5-87810874-0



H 1 : 49.5 (mm)  
H 2 : 47 (mm)  
OD 1 : 35 (mm)  
OD 2 : 35 (mm)  
ID 1 : 11.5 (mm)

CONT : 100  
VOL : 0.010

Note : Paper Wire Mesh

263

**F-56050** Fuel Filter Wire Mesh supported Element

KOMATSU 569-04-81270



H 1 : 145.5 (mm)  
H 2 : 140.5 (mm)  
OD 1 : 73 (mm)  
OD 2 : 76 (mm)  
ID 1 : 34 (mm)

CONT : 25  
VOL : 0.034

Note : Construction & Mining, Komatsu Dump Truck HD-465-7

268

**F-2626** Fuel Filter Metal End Cap Element

KOMATSU 6110-70-6202



H 1 : 145 (mm)  
H 2 : 130 (mm)  
OD 1 : 84.5 (mm)  
OD 2 : 84.5 (mm)  
ID 1 : 13 (mm)  
ID 2 : 13 (mm)

CONT : 50  
VOL : 0.062

Gasket Type : Square

259

**F-5218** Fuel Filter Metal End Cap Element

YANMAR 121850-55710



H 1 : 70 (mm)  
H 2 : 67 (mm)  
OD 1 : 35 (mm)  
OD 2 : 35 (mm)  
ID 1 : 11.5 (mm)

CONT : 50  
VOL : 0.013

Note : wire mesh Screen Fuel Strainer

264

**F-56060** Fuel Filter Metal End Cap Element

KOMATSU 20Y-04-J1130



H 1 : 193 (mm)  
OD 1 : 95 (mm)  
ID 1 : 25 (mm)

CONT : 12  
VOL : 0.029

269

**F-5202** Fuel Filter Metal End Cap Element

YANMAR 104500-55710  
HITACHI 4294842  
ISUZU 5-87810269-0  
JOHN DEERE CH15553  
FORD SBA130366040



H 1 : 69 (mm)  
H 2 : 66.5 (mm)  
OD 1 : 35 (mm)  
OD 2 : 35 (mm)  
ID 1 : 11 (mm)

CONT : 100  
VOL : 0.015

Note :

260

**F-5501** Fuel Filter Metal End Cap Element

CATERPILLAR 4H-8792  
CATERPILLAR 9H-4729



H 1 : 164 (mm)  
H 2 : 160.5 (mm)  
OD 1 : 88 (mm)  
OD 2 : 88 (mm)  
ID 1 : 25 (mm)  
ID 2 : 25 (mm)

CONT : 25  
VOL : 0.044

Note : Paper Protector

265

**F-5701** Fuel Filter Metal End Cap Element

CUMMINS 139097  
CUMMINS 256834



H 1 : 251.2 (mm)  
H 2 : 238 (mm)  
OD 1 : 147.7 (mm)  
OD 2 : 147.7 (mm)  
ID 1 : 25 (mm)  
ID 2 : 25 (mm)

CONT : 9  
VOL : 0.074

Note : Hanger, Paper Protector

270

**F-6502** Fuel Filter Secondary Metal End Cap Element

EUCLID 5573261  
CASE G-148B 1959



H 1 : 93 (mm)  
H 2 : 83 (mm)  
OD 1 : 74 (mm)  
OD 2 : 74 (mm)  
ID 1 : 26 (mm)  
ID 2 : 26 (mm)

CONT : 50  
VOL : 0.045

271

**FC-1006** Fuel Filter Spin-On

SUZUKI 15410-78E00  
SUZUKI 15411-78E00



H 1 : 120 (mm)  
OD 1 : 80 (mm)  
Thread Size : M20X1.5-6H  
Thread Nut Size : M22X1.5-6H  
Gasket Type : Round

CONT : 50  
VOL : 0.053

276

**FC-1503** Fuel Filter Spin-On High Efficiency

ISUZU 1-13240009-0  
ISUZU 1-13240041-0



H 1 : 125 (mm)  
OD 1 : 90 (mm)  
Thread Size : 3/4-16 UNF-2B  
Gasket Type : Round

CONT : 25  
VOL : 0.035

281

**F-6503** Fuel Filter Metal End Cap Element

CUMMINS 104790  
GENERAL MOTORS 5574508



H 1 : 199 (mm)  
H 2 : 189 (mm)  
OD 1 : 75.5 (mm)  
OD 2 : 75.5 (mm)  
ID 1 : 24.5 (mm)  
ID 2 : 24.5 (mm)

CONT : 50  
VOL : 0.073

272

**FC-1016** Fuel Filter Spin-On

MITSUBISHI ME 006066



H 1 : 80 (mm)  
OD 1 : 90 (mm)  
Thread Size : M20X1.5-6H  
Gasket Type : Square

CONT : 36  
VOL : 0.032

277

**FC-1702** Fuel Filter Can-type Housing

VW GROUP 061 198 552  
NISSAN 16403-76200  
VOLVO 236628  
VOLVO 236628/4



H 1 : 71 (mm)  
OD 1 : 84 (mm)  
OD 2 : 86.5 (mm)  
ID 1 : 19.5 (mm)  
ID 2 : 19.5 (mm)

CONT : 50  
VOL : 0.036

Note : rolled paper version

282

**F-6504** Fuel Filter Metal End Cap Element

EUCLID 5524979  
GENERAL MOTORS 6436719  
ATLAS COPCO 9709002102



H 1 : 217.8 (mm)  
H 2 : 201 (mm)  
OD 1 : 109.5 (mm)  
OD 2 : 109.5 (mm)  
ID 1 : 16 (mm)  
ID 2 : 16 (mm)

CONT : 12  
VOL : 0.043

Note : Hanger

273

**FC-1108** Fuel Filter Spin-On

TOYOTA 23390-33010  
TOYOTA 23390-64450  
DAIHATSU 23390-64450-000



H 1 : 122 (mm)  
OD 1 : 67.5 (mm)  
Thread Size : 3/4-16 UNF-2B  
Thread Nut Size : M36X1.5-6H  
Gasket Type : Round

CONT : 50  
VOL : 0.039

Note : not for common rail engine

278

**FC-1801** Fuel Filter Spin-On

NISSAN 16403-09W00  
NISSAN 16403-27000



H 1 : 80 (mm)  
OD 1 : 80 (mm)  
Thread Size : 3/4-16 UNF-2B  
Gasket Type : Round

CONT : 50  
VOL : 0.037

283

**F-6505** Fuel Filter Metal End Cap Element

EUCLID 5574961  
GENERAL MOTORS 5574961



H 1 : 139 (mm)  
H 2 : 134 (mm)  
OD 1 : 74 (mm)  
OD 2 : 74 (mm)  
ID 1 : 26 (mm)  
ID 2 : 26 (mm)

CONT : 25  
VOL : 0.034

274

**FC-1303** Fuel Filter Spin-On

HINO 23401-1190  
HINO 23401-1371  
HINO 23401-1400



H 1 : 125 (mm)  
OD 1 : 102 (mm)  
Thread Size : 1-14 UNS-2B  
Gasket Type : Round

CONT : 12  
VOL : 0.022

Note : Seat Zinc Coating

279

**FC-1802** Fuel Filter Spin-On

NISSAN 16405-34W00  
NISSAN 16405-R8104  
NISSAN 16405-R8300



H 1 : 116 (mm)  
OD 1 : 80 (mm)  
Thread Size : 3/4-16 UNF-2B  
Thread Nut Size : M10X1.5  
Gasket Type : Round

CONT : 50  
VOL : 0.050

Note : Rolled paper version see FC-1819

284

**F-7302** Fuel Filter Sock Element

CASE 434871R91  
GENERAL MOTORS 5575032



H 1 : 213 (mm)  
H 2 : 213 (mm)  
OD 1 : 75 (mm)  
OD 2 : 75 (mm)  
ID 1 : 31.5 (mm)  
ID 2 : 31.5 (mm)

CONT : 25  
VOL : 0.052

275

**FC-1501** Fuel Filter Spin-On

NISSAN 16403-89TA1  
NISSAN 16403-J5500  
HITACHI 4285643



H 1 : 87 (mm)  
OD 1 : 80 (mm)  
Thread Size : 3/4-16 UNF-2B  
Gasket Type : Round

CONT : 50  
VOL : 0.039

280

**FC-1810** Fuel Filter Spin-On with head body

NISSAN 16403-99013  
NISSAN 16403-NY001



H 1 : 145 (mm)  
OD 1 : 93 (mm)  
Thread Size : 1-14 UNS-2B  
Gasket Type : Square

CONT : 12  
VOL : 0.024

285



**FC-5103** Fuel Filter Can-type Housing

ALLIS CHALMERS 1919100  
MANITOU 49660  
CASE K915319



H 1 : 71 (mm)  
OD 1 : 85 (mm)  
OD 2 : 89 (mm)  
ID 1 : 39 (mm)  
ID 2 : 15 (mm)

CONT : 50  
VOL : 0.036

286

**FC-5521** Fuel Filter Spin-On

CUMMINS 3973232  
NEW HOLLAND (CNH) 87360572



H 1 : 174 (mm)  
OD 1 : 93 (mm)  
Thread Size : 7/8-14 UNF-2B  
Gasket Type : Square

CONT : 12  
VOL : 0.027

291

**FC-5606** Fuel Filter Spin-On

KOMATSU 600-311-8282  
KOMATSU 600-311-8293



H 1 : 150 (mm)  
H 2 : 141 (mm)  
OD 1 : 93 (mm)  
Thread Size : 1-14 UNS-2B  
Gasket Type : Square

CONT : 12  
VOL : 0.020

Note : Drain Nut

296

**FC-5201** Fuel Filter Spin-On

YANMAR 123907-55800



H 1 : 150 (mm)  
OD 1 : 90 (mm)  
Thread Size : M20X1.5-6H  
Gasket Type : Round

CONT : 25  
VOL : 0.052

287

**FC-5601** Fuel Filter Spin-On

KOMATSU 600-311-8220  
KOMATSU 6136-71-6120



H 1 : 143 (mm)  
OD 1 : 80 (mm)  
Thread Size : 3/4-16 UNF-2B  
Gasket Type : Round

CONT : 25  
VOL : 0.031

292

**FC-5610** Fuel Filter Spin-On

KOMATSU 600-311-8321



H 1 : 145 (mm)  
OD 1 : 93 (mm)  
Thread Size : 1-14 UNS-2B  
Gasket Type : Square

CONT : 12  
VOL : 0.023

Note :

297

**FC-5403** Fuel Filter Spin-On With Drain Plug

ATLAS COPCO 1619-2684  
DEUTZ 2133558  
DEUTZ 2133943



H 1 : 173.4 (mm)  
H 2 : 148 (mm)  
OD 1 : 76 (mm)  
Thread Size : M16X1.5-6H  
Gasket Type : Square

CONT : 25  
VOL : 0.041

Note :

288

**FC-5602** Fuel Filter Spin-On

ISUZU 1-13240044-0  
KOMATSU 600-311-8291  
ISUZU X1.3240021



H 1 : 175 (mm)  
OD 1 : 80 (mm)  
Thread Size : 1-14 UNS-2B  
Gasket Type : Round

CONT : 12  
VOL : 0.026

293

**FC-5612** Fuel Filter Spin-On

KOMATSU 600-311-3510  
KOMATSU 600-319-3510



H 1 : 286 (mm)  
OD 1 : 118 (mm)  
Thread Size : 1 1/4-12 UNF-2B  
Gasket Type : Square

CONT : 6  
VOL : 0.038

Note : High performance grade uses FC-5622

298

**FC-54050** Fuel Filter Secondary Spin-On

THERMO-KING 11.3855  
GALION 120301  
CASE 359251C1  
CASE 674293C1  
KOMATSU 674293C1



H 1 : 220 (mm)  
OD 1 : 93 (mm)  
Thread Size : 7/8-14 UNF-2B  
Gasket Type : Square

CONT : 12  
VOL : 0.031

289

**FC-5604** Fuel Filter Spin-On

KOMATSU 600-311-6220  
KOMATSU 600-311-6221  
KOMATSU 600-311-7410



H 1 : 87 (mm)  
OD 1 : 80 (mm)  
Thread Size : 3/4-16 UNF-2B  
Gasket Type : Round

CONT : 50  
VOL : 0.039

294

**FC-5613** Fuel Filter Spin-On High Efficiency

KOMATSU 6754-71-6130  
KOMATSU 6754-71-6140  
KOMATSU 6754-79-6130



H 1 : 174 (mm)  
OD 1 : 93 (mm)  
Thread Size : M20X1.5-6H  
Gasket Type : Square

CONT : 12  
VOL : 0.025

Note : absolute micron rating 4.69, single layer media

299

**FC-5501** Fuel Filter Spin-On

CATERPILLAR 1P-2299



H 1 : 174 (mm)  
OD 1 : 93 (mm)  
Thread Size : 1-14 UNS-2B  
Gasket Type : Square

CONT : 25  
VOL : 0.052

Note : High Performance Grade Uses FC-5523

290

**FC-5605** Fuel Filter Spin-On

KOMATSU 600-311-8221



H 1 : 148 (mm)  
OD 1 : 76 (mm)  
Thread Size : 3/4-16 UNF-2B  
Gasket Type : Square

CONT : 25  
VOL : 0.027

Note : FC-5605=Height 148 MM, FC-5618= Height 114.7 MM

295

**FC-5614** Fuel Filter Spin-On High Efficiency

KOMATSU 600-311-3520



H 1 : 286 (mm)  
OD 1 : 115.5 (mm)  
Thread Size : 1 5/8-12 UNF-2B  
Gasket Type : Square

CONT : 6  
VOL : 0.033

Note : For high pressure fuel injection systems

300

**FC-5615** Fuel Filter Spin-On High Efficiency



CUMMINS 4942437  
CUMMINS 4946635  
YALE & TOWNE 580090996  
KOMATSU 600-311-3530  
KOMATSU 600-319-3530

H 1 : 143.5 (mm)  
OD 1 : 80 (mm)  
Thread Size : M22X1.5-6H  
Gasket Type : Round

CONT : 25  
VOL : 0.034

Note : For High Pressure Fuel Injection Systems

**FC-56290** Fuel Filter Spin-On High Efficiency



KOMATSU 600-311-3870  
KOMATSU 600-319-3870

H 1 : 148 (mm)  
OD 1 : 80 (mm)  
Thread Size : 13/16-16 UNF-2B  
Gasket Type : Round

CONT : 25  
VOL : 0.034

Note : for Komatsu Excavator PC70-8

**FC-5703** Fuel Filter Spin-On High Efficiency



MTU 0010925601  
CUMMINS 299202  
CUMMINS 3313306  
KOMATSU 600-311-7130

H 1 : 286 (mm)  
OD 1 : 118 (mm)  
Thread Size : 1 1/4-12 UNF-2B  
Gasket Type : Square

CONT : 6  
VOL : 0.030

**FC-5621** Fuel Filter Spin-On



KOMATSU 600-311-9120  
KOMATSU 600-311-9121

H 1 : 174 (mm)  
OD 1 : 93 (mm)  
OD 2 : 92.7 (mm)  
Thread Size : 1-14 UNS-2B  
Thread Nut Size : M8X1.25  
Gasket Type : Square

CONT : 12  
VOL : 0.024

**FC-56300** Fuel Filter Spin-On High Efficiency



KOMATSU 600-311-3841  
KOMATSU 600-319-3841

H 1 : 275 (mm)  
OD 1 : 125 (mm)  
Thread Size : 1 3/8-12 UNF-2B  
Gasket Type : Square

CONT : 6  
VOL : 0.033

**FC-5704** Fuel Filter Spin-On



VOLVO 241672  
VOLVO 243004  
MASSEY-FERGUSON 2871513M1

H 1 : 123 (mm)  
OD 1 : 76 (mm)  
Thread Size : M16X1.5-6H  
Gasket Type : Square

CONT : 50  
VOL : 0.047

Note : With Center Tube

**FC-5622** Fuel Filter Spin-On High Efficiency



KOMATSU 600-311-3310  
KOMATSU 600-311-3510  
KOMATSU 600-319-3310  
KOMATSU 600-319-3510

H 1 : 286 (mm)  
OD 1 : 118 (mm)  
Thread Size : 1 1/4-12 UNF-2B  
Gasket Type : Square

CONT : 6  
VOL : 0.032

Note : For high pressure fuel injection systems

**FC-56310** Fuel Filter Spin-On High Efficiency



KOMATSU 22H-04-11240

H 1 : 100 (mm)  
H 2 : 100 (mm)  
OD 1 : 80 (mm)  
Thread Size : M20X1.5-6H  
Gasket Type : Round

CONT : 50  
VOL : 0.041

Note : for Komatsu PC56-7

**FC-5713** Fuel Filter Spin-On



CUMMINS 3959612

H 1 : 174 (mm)  
OD 1 : 93 (mm)  
Thread Size : 7/8-14 UNF-2B  
Gasket Type : Square

CONT : 12  
VOL : 0.027

Note : 5 micron

**FC-56230** Fuel Filter Spin-On High Efficiency



KOMATSU 600-311-3550  
KOMATSU 600-319-3550

H 1 : 286 (mm)  
OD 1 : 115.5 (mm)  
Thread Size : 1 5/8-12 UNF-2B  
Gasket Type : Square

CONT : 6  
VOL : 0.034

Note : For high pressure fuel injection systems

**FC-56320** Fuel Filter Spin-On High Efficiency



KOMATSU 600-319-3881

H 1 : 148 (mm)  
OD 1 : 80 (mm)  
Thread Size : 13/16-16 UNF-2B  
Gasket Type : Round

CONT : 24  
VOL : 0.031

Note : Alternate parts FC-56290

**FC-5715** Fuel Filter Spin-On With Drain Plug



KHD(KLOCKNER-HUMBOLT-DEUTZ ) 1174482  
J.C.BAMFORD 32/912001

H 1 : 163 (mm)  
OD 1 : 81.5 (mm)  
Thread Size : M16X1.5-6H  
Thread Nut Size : M8X1.25  
Gasket Type : Square

CONT : 25  
VOL : 0.037

**FC-56270** Fuel Filter Spin-On High Efficiency



KOMATSU 600-319-3750

H 1 : 174 (mm)  
OD 1 : 93 (mm)  
Thread Size : 7/8-14 UNF-2B  
Gasket Type : Square

CONT : 12  
VOL : 0.027

**FC-5702** Fuel Filter Spin-On



MITSUBISHI 32540-20300  
MITSUBISHI 32562-20300  
HITACHI 4085912

H 1 : 175 (mm)  
OD 1 : 93 (mm)  
Thread Size : 1-14 UNS-2B  
Gasket Type : Square

CONT : 12  
VOL : 0.030

Note : Drain nut

**FC-5720** Fuel Filter Spin-On



CUMMINS 154709  
CUMMINS 3315844

H 1 : 135 (mm)  
OD 1 : 93 (mm)  
Thread Size : 1-14 UNS-2B  
Gasket Type : Square

CONT : 12  
VOL : 0.021

Note : Is a short version of FC-57270

**FC-5721** Fuel Filter Spin-On



CUMMINS 156172  
FIAT-ALLIS 70697633  
FORD 749F9176AAA  
VOLVO 79250023

H 1 : 136 (mm)  
OD 1 : 93 (mm)  
Thread Size : 1-14 UNS-2B  
Gasket Type : Square

CONT : 12  
VOL : 0.023

316

**FC-6502** Fuel Filter Secondary Spin-On



GENERAL MOTORS 25010778  
GENERAL MOTORS 6438840

Primary Filter uses FC-6501

H 1 : 175 (mm)  
OD 1 : 93 (mm)  
Thread Size : 13/16-12 UNF-2B  
Gasket Type : Square

CONT : 12  
VOL : 0.025

321

**FS-5601** Fuel Filter Metal body In-Line



CASE 194199A1  
KOMATSU 2070-4A1100

H 1 : 94 (mm)  
H 2 : 60 (mm)  
OD 1 : 50 (mm)  
OD 2 : 44 (mm)  
Inlet : 13 (mm)  
Outlet : 13 (mm)

CONT : 50  
VOL : 0.019

326

**FC-57290** Fuel Filter Spin-On High Efficiency



CUMMINS 4964234

H 1 : 262 (mm)  
OD 1 : 118 (mm)  
Thread Size : 2 1/4-12 UNF-2B

CONT : 6  
VOL : 0.032

317

**FC-6505** Fuel Filter Spin-On



GENERAL MOTORS 23518528  
GENERAL MOTORS 25011024

H 1 : 228 (mm)  
OD 1 : 118 (mm)  
Thread Size : 1 1/4-12 UNF-2B  
Gasket Type : Square

CONT : 6  
VOL : 0.027

322

**FS-5701** Fuel Filter Metal body In-Line

CUMMINS 3826094  
NEW HOLLAND (CNH) 86597473

H 1 : 96 (mm)  
OD 1 : 44.5 (mm)  
Inlet : 10 (mm)  
Outlet : 10 (mm)

CONT : 12  
VOL : 0.005

327

**FC-6202** Fuel Filter Spin-On



MERCEDES-BENZ 000 092 83 01  
MERCEDES-BENZ 000 092 94 01  
DEUTZ 1161003

H 1 : 140 (mm)  
OD 1 : 93 (mm)  
Thread Size : M16X1.5-6H  
Gasket Type : Square

CONT : 25  
VOL : 0.041

318

**FC-6506** Fuel Filter Spin-On



DETROIT DIESEL 23518532  
GENERAL MOTORS 23518532  
GENERAL MOTORS 25011026

H 1 : 228 (mm)  
OD 1 : 118 (mm)  
Thread Size : 1 1/16-16 UNF-2B  
Gasket Type : Square

CONT : 6  
VOL : 0.027

323

**H-2706** Hydraulic Oil Filter Suction Wire Mesh supported Element

YANMAR 172162-73700  
HITACHI 4210224

H 1 : 134.8 (mm)  
H 2 : 128 (mm)  
OD 1 : 150 (mm)  
OD 2 : 150 (mm)  
ID 1 : 87 (mm)  
Thread Size : M10X1.5-6H

CONT : 6  
VOL : 0.028

328

**FC-6205** Fuel Filter Spin-On



DEUTZ 1174424  
CROSLAND 5003

H 1 : 79 (mm)  
OD 1 : 76 (mm)  
Thread Size : M16X1.5-6H  
Gasket Type : Square

CONT : 50  
VOL : 0.031

Note : With center tube

319

**FC-7903** Fuel Filter Secondary Spin-On High Efficiency



J.C.BAMFORD 02/910155  
CUMMINS 3903640  
CUMMINS 3931063

H 1 : 115 (mm)  
OD 1 : 76 (mm)  
Thread Size : M16X1.5-6H  
Gasket Type : Square

CONT : 25  
VOL : 0.023

324

**H-2709** Hydraulic Oil Filter Metal End Cap Element

KOMATSU 07063-01383  
KOMATSU 208-60-61150  
HITACHI 4287634  
HITACHI 76580323

H 1 : 450 (mm)  
OD 1 : 180 (mm)  
OD 2 : 180 (mm)  
ID 1 : 110 (mm)  
ID 2 : 110 (mm)

CONT : 9  
VOL : 0.173

329

**FC-6501** Fuel Filter Primary Spin-On



GENERAL MOTORS 25014274  
GENERAL MOTORS 6438839

Secondary Filter uses FC-6502

H 1 : 203 (mm)  
OD 1 : 93 (mm)  
Thread Size : 1-12 UNF-2B  
Gasket Type : Square

CONT : 12  
VOL : 0.028

320

**FC-7933** Fuel Filter Spin-On



CASE 672603C2

H 1 : 200 (mm)  
OD 1 : 108 (mm)  
Thread Size : 7/8-14 UNF-2B  
Gasket Type : Square

CONT : 6  
VOL : 0.021

325

**H-42300** Hydraulic Breather Foam Element

KOMATSU 423-60-35460

H 1 : 14 (mm)  
OD 1 : 47 (mm)  
OD 2 : 47 (mm)  
ID 1 : 33 (mm)  
ID 2 : 33 (mm)

CONT : 100  
VOL : 0.015

330

# Sakura Filter

# Technical Specification

**H-5406** Hydraulic Oil Filter Metal End Cap Element

INTERNATIONAL HARVESTER 631144 C1  
INTERNATIONAL HARVESTER 631144 C2



H 1 : 228 (mm)  
OD 1 : 114 (mm)  
OD 2 : 114 (mm)  
ID 1 : 58.5 (mm)  
ID 2 : 13.5 (mm)

CONT : 20  
VOL : 0.074

331

**H-55270** Hydraulic Oil Filter Metal End Cap Element with synthetic media

CATERPILLAR 4T-3131



H 1 : 231 (mm)  
OD 1 : 101 (mm)  
OD 2 : 101 (mm)  
ID 1 : 59 (mm)  
ID 2 : 59 (mm)

CONT : 12  
VOL : 0.028

336

**H-5608** Hydraulic Oil Filter Metal End Cap Element

KOMATSU 130-60-48210



H 1 : 278.5 (mm)  
OD 1 : 65 (mm)  
OD 2 : 65 (mm)  
ID 1 : 25.5 (mm)  
ID 2 : 25.5 (mm)

CONT : 25  
VOL : 0.041

341

**H-5503** Hydraulic Oil Filter Metal End Cap Element

CATERPILLAR 1R-0720  
CATERPILLAR 4J-6064



H 1 : 228 (mm)  
OD 1 : 130 (mm)  
OD 2 : 130 (mm)  
ID 1 : 84.4 (mm)  
ID 2 : 84.4 (mm)

CONT : 20  
VOL : 0.105

Note : Performance grade uses H-5526

332

**H-55280** Hydraulic Oil Filter Metal End Cap Element with synthetic media

CATERPILLAR 132-8876  
CATERPILLAR 4T-3132



H 1 : 228.2 (mm)  
H 2 : 225 (mm)  
OD 1 : 130 (mm)  
OD 2 : 130 (mm)  
ID 1 : 84.4 (mm)  
ID 2 : 84.4 (mm)

CONT : 6  
VOL : 0.031

337

**H-5609** Hydraulic Oil Filter Metal End Cap Element Cellulose media

KOMATSU 07063-01142  
KOMATSU 07063-01412  
KOMATSU 195-60-16320



H 1 : 300.5 (mm)  
OD 1 : 150 (mm)  
OD 2 : 150 (mm)  
ID 1 : 110 (mm)  
ID 2 : 110 (mm)

CONT : 6  
VOL : 0.059

342

**H-5504** Hydraulic Oil Filter Metal End Cap Element

CATERPILLAR 1R-0719  
CATERPILLAR 2M-3943  
CATERPILLAR 9M-9740



H 1 : 234 (mm)  
OD 1 : 101 (mm)  
OD 2 : 101 (mm)  
ID 1 : 59 (mm)  
ID 2 : 59 (mm)

CONT : 20  
VOL : 0.071

333

**H-5601** Hydraulic Oil Filter Metal End Cap Element

KOMATSU 144-60-11160



H 1 : 277 (mm)  
OD 1 : 100 (mm)  
OD 2 : 100 (mm)  
ID 1 : 60 (mm)  
ID 2 : 60 (mm)

CONT : 25  
VOL : 0.092

338

**H-5610** Hydraulic Oil Filter Metal End Cap Element

KOMATSU 07063-01100  
KOMATSU 141-60-18270  
KOMATSU 175-60-27380



H 1 : 292 (mm)  
OD 1 : 130 (mm)  
OD 2 : 130 (mm)  
ID 1 : 86 (mm)  
ID 2 : 86 (mm)

CONT : 6  
VOL : 0.040

343

**H-5519** Hydraulic Oil Filter Metal End Cap Element

SUMITOMO KRJ 1599



H 1 : 291 (mm)  
OD 1 : 112 (mm)  
OD 2 : 112 (mm)  
ID 1 : 70 (mm)  
ID 2 : 70 (mm)

CONT : 9  
VOL : 0.049

334

**H-5606** Hydraulic Oil Filter Metal End Cap Element

KOMATSU 175-49-11580  
KOMATSU 2-3EB-66-21140



H 1 : 233.3 (mm)  
H 2 : 231 (mm)  
OD 1 : 100 (mm)  
OD 2 : 100 (mm)  
ID 1 : 42 (mm)  
ID 2 : 35.8 (mm)

CONT : 20  
VOL : 0.074

339

**H-56100** Hydraulic Oil Filter Metal End Cap Element

KOMATSU 22P-60-21161



H 1 : 104.5 (mm)  
H 2 : 99.5 (mm)  
OD 1 : 110 (mm)  
OD 2 : 110 (mm)  
ID 1 : 61 (mm)  
ID 2 : 61 (mm)

CONT : 25  
VOL : 0.048

344

**H-5526** Hydraulic Oil Filter Metal End Cap Element With Microfiber media

CATERPILLAR 4J-6064  
CATERPILLAR 9W-6428



H 1 : 228 (mm)  
OD 1 : 130 (mm)  
OD 2 : 130 (mm)  
ID 1 : 85 (mm)  
ID 2 : 85 (mm)

CONT : 12  
VOL : 0.062

335

**H-5607** Hydraulic Oil Filter Metal End Cap Element

KOMATSU 07063-01054  
KOMATSU 154-60-12170  
KOMATSU ZZ0706301054



H 1 : 211 (mm)  
OD 1 : 100 (mm)  
OD 2 : 100 (mm)  
ID 1 : 60 (mm)  
ID 2 : 60 (mm)

CONT : 20  
VOL : 0.059

340

**H-5611** Hydraulic Oil Filter Metal End Cap Element

KOMATSU 101-60-15170  
KOMATSU 101-60-15171



H 1 : 143 (mm)  
OD 1 : 64.8 (mm)  
OD 2 : 64.8 (mm)  
ID 1 : 25.5 (mm)  
ID 2 : 25.5 (mm)

CONT : 50  
VOL : 0.050

345

**H-56110** Hydraulic Oil Filter Metal End Cap Element  
KOMATSU 3EC-66-71540



H 1 : 133.5 (mm)  
H 2 : 131 (mm)  
OD 1 : 83 (mm)  
OD 2 : 83 (mm)  
ID 1 : 41.8 (mm)  
ID 2 : 41.8 (mm)

CONT : 25  
VOL : 0.038

346

**H-5625** Hydraulic Oil Filter Metal End Cap Element  
YANMAR 172141-73760  
KOMATSU 311781-31140



H 1 : 178 (mm)  
OD 1 : 89 (mm)  
OD 2 : 89 (mm)  
ID 1 : 60 (mm)  
ID 2 : 60 (mm)

CONT : 25  
VOL : 0.057

351

**H-5639** Hydraulic Oil Filter Metal End Cap Element with synthetic media  
KOMATSU 208-60-71121  
KOMATSU 208-60-71122A



H 1 : 200 (mm)  
OD 1 : 180 (mm)  
OD 2 : 180 (mm)  
ID 1 : 110 (mm)  
ID 2 : 110 (mm)

CONT : 6  
VOL : 0.051

356

**H-5613** Hydraulic Oil Filter Metal End Cap Element  
KOMATSU 205-60-51450



H 1 : 197 (mm)  
H 2 : 190 (mm)  
OD 1 : 150 (mm)  
OD 2 : 150 (mm)  
ID 1 : 73.5 (mm)  
Thread Size : M10X1.5-6H

CONT : 9  
VOL : 0.053

347

**H-5629** Hydraulic Oil Filter Metal End Cap Element with synthetic media  
KOMATSU 207-60-71180



H 1 : 200 (mm)  
OD 1 : 150 (mm)  
OD 2 : 150 (mm)  
ID 1 : 92 (mm)  
ID 2 : 92 (mm)

CONT : 10  
VOL : 0.069

352

**H-5641** Hydraulic Oil Filter Metal End Cap Element  
KOMATSU 144-49-13853



H 1 : 162.6 (mm)  
H 2 : 139.5 (mm)  
OD 1 : 60 (mm)  
OD 2 : 60 (mm)  
ID 1 : 26.5 (mm)  
ID 2 : 26.5 (mm)

CONT : 25  
VOL : 0.025

357

**H-5618** Hydraulic Oil Filter Metal End Cap Element  
MITSUBISHI 385-10100021  
MITSUBISHI 385-10100022  
KOMATSU 424-16-11140



H 1 : 229.6 (mm)  
H 2 : 227 (mm)  
OD 1 : 110 (mm)  
OD 2 : 110 (mm)  
ID 1 : 44 (mm)  
ID 2 : 44 (mm)

CONT : 20  
VOL : 0.074

348

**H-56292** Hydraulic Oil Filter Wire Mesh supported Element  
KOMATSU 207-60-71183



H 1 : 205 (mm)  
H 2 : 200 (mm)  
OD 1 : 150 (mm)  
OD 2 : 150 (mm)  
ID 1 : 92 (mm)  
ID 2 : 92 (mm)

CONT : 9  
VOL : 0.060

Note : 2000 Hoken Komatsu Excavator

353

**H-5646** Hydraulic Oil Filter Metal End Cap Element Cellulose media  
KOMATSU 207-60-71180



H 1 : 200 (mm)  
OD 1 : 150 (mm)  
OD 2 : 150 (mm)  
ID 1 : 92 (mm)  
ID 2 : 92 (mm)

CONT : 10  
VOL : 0.062

Note : H-5629 (Media difference)

358

**H-5620** Hydraulic Oil Filter Metal End Cap Element  
KOMATSU 281-16-11290  
KOMATSU 287-16-11510



H 1 : 233 (mm)  
OD 1 : 100 (mm)  
OD 2 : 100 (mm)  
ID 1 : 42 (mm)  
ID 2 : 42 (mm)

CONT : 20  
VOL : 0.074

349

**H-5632** Hydraulic Oil Filter Element  
KOMATSU 3EB-66-11711  
KOMATSU 3EB6-61-1710  
KOMATSU 3EB7-61-1710  
KOMATSU 3EB7-61-1711



H 1 : 165 (mm)  
H 2 : 152 (mm)  
OD 1 : 90 (mm)  
OD 2 : 90 (mm)  
Thread Size : 3/4 BSPT

CONT : 25  
VOL : 0.053

354

**H-5652** Hydraulic Oil Filter Metal End Cap Element  
KOMATSU 285-62-17320A



H 1 : 51.8 (mm)  
OD 1 : 52 (mm)  
OD 2 : 52 (mm)  
ID 1 : 37.5 (mm)  
ID 2 : 37.5 (mm)

CONT : 50  
VOL : 0.011

359

**H-5622** Hydraulic Oil Filter Metal End Cap Element  
KOMATSU 198-49-11440



H 1 : 291.5 (mm)  
OD 1 : 112 (mm)  
OD 2 : 112 (mm)  
ID 1 : 70 (mm)  
ID 2 : 70 (mm)

CONT : 10  
VOL : 0.051

350

**H-5635** Hydraulic Oil Filter Metal End Cap Element  
KOMATSU 22B-60-11160



H 1 : 138.5 (mm)  
H 2 : 130.5 (mm)  
OD 1 : 125 (mm)  
OD 2 : 124 (mm)  
ID 1 : 97.8 (mm)  
Thread Size : M10X1.5-6H

CONT : 12  
VOL : 0.036

355

**H-56530** Hydraulic Oil Filter Metal End Cap Element with synthetic media  
KOMATSU 22L-60-22120



H 1 : 131 (mm)  
OD 1 : 83.2 (mm)  
OD 2 : 83.2 (mm)  
ID 1 : 42.2 (mm)  
ID 2 : 42.2 (mm)

CONT : 25  
VOL : 0.034

360

# Sakura Filter

# Technical Specification

**H-56540** Hydraulic Oil Filter Metal End Cap Element Synthetic Media  
KOMATSU 21W-60-41121



H 1 : 100 (mm)  
OD 1 : 110 (mm)  
OD 2 : 110 (mm)  
ID 1 : 61 (mm)  
ID 2 : 61 (mm)

CONT : 12  
VOL : 0.021

361

**H-56650** Hydraulic Oil Filter Metal End Cap Element With Microfiber media  
KOMATSU 14X-60-31150



H 1 : 200 (mm)  
OD 1 : 110 (mm)  
OD 2 : 110 (mm)  
ID 1 : 61 (mm)  
ID 2 : 61 (mm)

CONT : 9  
VOL : 0.029

366

**H-56770** Hydraulic Oil Filter Metal End Cap Element  
KOMATSU 209-38-12470  
KOMATSU 421-43-27920



H 1 : 82.5 (mm)  
OD 1 : 42.5 (mm)  
OD 2 : 42.5 (mm)  
ID 1 : 21 (mm)

CONT : 50  
VOL : 0.019

371

**H-56570** Hydraulic Oil Filter Transmission Wire Mesh supported Element  
KOMATSU 195-13-13420



H 1 : 90 (mm)  
H 2 : 85.5 (mm)  
OD 1 : 57 (mm)  
OD 2 : 57 (mm)  
ID 1 : 43 (mm)  
ID 2 : 6.6 (mm)

CONT : 50  
VOL : 0.028

362

**H-56652** Hydraulic Oil Filter Metal End Cap Element  
KOMATSU 423-60-45461



H 1 : 204 (mm)  
OD 1 : 110 (mm)  
OD 2 : 110 (mm)  
ID 1 : 61 (mm)  
ID 2 : 61 (mm)

CONT : 12  
VOL : 0.041

367

**H-62110** Hydraulic Oil Filter Metal End Cap Element  
KOMATSU 6964737  
LIEBHERR 736 4368



H 1 : 213 (mm)  
H 2 : 167 (mm)  
OD 1 : 81.5 (mm)  
OD 2 : 71 (mm)  
ID 1 : 40 (mm)

CONT : 9  
VOL : 0.019

372

**H-56580** Hydraulic Oil Filter Metal End Cap Element  
KOMATSU 569-43-83920



H 1 : 207.5 (mm)  
H 2 : 203 (mm)  
OD 1 : 51 (mm)  
OD 2 : 51 (mm)  
ID 1 : 23 (mm)

CONT : 12  
VOL : 0.010

363

**H-56690** Hydraulic Oil Filter Metal End Cap Element  
KOMATSU 207-60-61250



H 1 : 144 (mm)  
OD 1 : 30 (mm)  
OD 2 : 34 (mm)  
ID 1 : 21 (mm)

CONT : 25  
VOL : 0.015

368

**H-65030** Hydraulic Oil Filter Transmission Metal End Cap Element  
VOLVO 15052  
HITACHI 1930779  
GENERAL MOTORS 25010836  
GENERAL MOTORS 25011193  
ALLIS CHALMERS 618179



H 1 : 228 (mm)  
H 2 : 226 (mm)  
OD 1 : 109.5 (mm)  
OD 2 : 109.5 (mm)  
ID 1 : 38.3 (mm)  
ID 2 : 38.3 (mm)

CONT : 12  
VOL : 0.043

373

**H-56600** Hydraulic Oil Filter Metal End Cap Element with synthetic media  
KOMATSU 07063-51100



H 1 : 292 (mm)  
OD 1 : 130 (mm)  
OD 2 : 130 (mm)  
ID 1 : 86 (mm)  
ID 2 : 86 (mm)

CONT : 1  
VOL : 0.010

364

**H-56700** Hydraulic Oil Filter Wire Mesh supported Element  
KOMATSU 421-43-H0P43



H 1 : 71 (mm)  
H 2 : 65.5 (mm)  
OD 1 : 56 (mm)  
OD 2 : 56 (mm)  
ID 1 : 27 (mm)

CONT : 50  
VOL : 0.025

Note : Komatsu wheel Loader WA320-3H Active, WA420-3H

369

**H-7105** Hydraulic Oil Filter additional part Metal End Cap Element With Microfiber media  
VOLVO 14532686  
HITACHI 4157882



H 1 : 86 (mm)  
H 2 : 82.5 (mm)  
OD 1 : 42.5 (mm)  
OD 2 : 42.5 (mm)  
ID 1 : 21.5 (mm)

CONT : 50  
VOL : 0.019

374

**H-56610** Hydraulic Breather Foam Element  
KOMATSU 204-60-21470  
KOMATSU 20Y-60-21470



H 1 : 23 (mm)  
OD 1 : 47 (mm)  
OD 2 : 47 (mm)  
ID 1 : 33 (mm)  
ID 2 : 33 (mm)

CONT : 100  
VOL : 0.008

365

**H-56740** Hydraulic Oil Filter Aluminium casting end cap, Element  
KOMATSU 562-15-11570



H 1 : 255 (mm)  
H 2 : 138.5 (mm)  
OD 1 : 78 (mm)  
OD 2 : 70 (mm)  
ID 1 : 10 (mm)  
Thread Size : M10X1.5-6H

CONT : 25  
VOL : 0.058

Note : with magnet

370

**H-7911** Hydraulic Oil Filter Metal End Cap Element  
KOMATSU 07063-01210  
KOMATSU 205-60-51430



H 1 : 450 (mm)  
OD 1 : 150 (mm)  
OD 2 : 150 (mm)  
ID 1 : 110 (mm)  
ID 2 : 110 (mm)

CONT : 6  
VOL : 0.080

Note : Without gasket

375

# Sakura Filter

# Technical Specification

**H-7972** Hydraulic Oil Filter Metal End Cap Element With Microfiber media

FAIREY ARLON 370L110A  
FAIREYAR 370L123A  
FAIREYAR 370L123GDH20  
CATERPILLAR 3I1955



H 1 : 101.5 (mm)  
H 2 : 94.5 (mm)  
OD 1 : 93 (mm)  
OD 2 : 93 (mm)  
ID 1 : 47 (mm)

CONT : 25  
VOL : 0.036

376

**HC-5402** Hydraulic Oil Filter Spin-On

INTERNATIONAL HARVESTER  
1103452C2  
INTERNATIONAL HARVESTER  
1103462-C1



H 1 : 225 (mm)  
OD 1 : 127 (mm)  
Thread Size : 3X8

CONT : 6  
VOL : 0.031

381

**HC-5601** Hydraulic Oil Filter Spin-On

KOMATSU 113-60-23160



H 1 : 228 (mm)  
OD 1 : 108 (mm)  
Thread Size : 1 1/8-16 UNF-2B  
Gasket Type : Square

CONT : 6  
VOL : 0.023

386

**H-85680** Hydraulic Oil Filter Metal End Cap Element

SUMITOMO KRJ15830  
SUMITOMO KRJ20710



H 1 : 454 (mm)  
H 2 : 449 (mm)  
OD 1 : 150 (mm)  
OD 2 : 150 (mm)  
ID 1 : 110 (mm)  
ID 2 : 110 (mm)

CONT : 1  
VOL : 0.013

377

**HC-5502** Hydraulic Oil Filter Spin-On

DEMAG 04425274  
DEMAG 4425274  
JOHN DEERE AZ36942



H 1 : 305 (mm)  
OD 1 : 136 (mm)  
Thread Size : 1 1/2-16 UN-2B  
ADBV : YES  
Gasket Type : Square

CONT : 6  
VOL : 0.050

382

**HC-5602** Hydraulic Oil Filter Spin-On

KOMATSU 113-60-43320  
KOMATSU 113-60-43321  
KOMATSU 209-607-6210  
HITACHI 4205684  
KUBOTA 68773-62230



H 1 : 171 (mm)  
OD 1 : 125 (mm)  
Thread Size : M48X2-6H

CONT : 6  
VOL : 0.026

387

**HC-1119** Hydraulic Oil Filter Transmission Spin-On

TOYOTA 32670-12620-71



H 1 : 80 (mm)  
OD 1 : 74 (mm)  
Thread Size : 3/4-16 UNF-2B  
BPV (kg/cm2) : 1.0  
ADBV : YES  
Gasket Type : Round

CONT : 50  
VOL : 0.030

378

**HC-5507** Hydraulic Oil Filter Spin-On Synthetic Media

CATERPILLAR 144-6691  
DEUTZ 4118911  
CLARK 6661248  
NEW HOLLAND (CNH) 920019190



H 1 : 152 (mm)  
OD 1 : 94.5 (mm)  
Thread Size : 1 3/8-12 UNF-2B

CONT : 12  
VOL : 0.024

383

**HC-5603** Hydraulic Oil Filter Return Spin-On

KOMATSU 21N-60-12210  
YAMASHIN CSP-10L-10



H 1 : 289 (mm)  
OD 1 : 127 (mm)  
Thread Size : M48X2-6H

CONT : 6  
VOL : 0.046

388

**HC-2701** Hydraulic Oil Filter Transmission Spin-On

HITACHI 4230376  
HITACHI 4286837  
KOMATSU BW252116



H 1 : 200 (mm)  
OD 1 : 93 (mm)  
Thread Size : 1-12 UNF-2B  
Thread Nut Size : M24X1.5  
BPV (kg/cm2) : 2.5  
Gasket Type : Square

CONT : 12  
VOL : 0.036

379

**HC-5508** Hydraulic Oil Filter Spin-On Synthetic Media

KOMATSU 1281327H1  
CASE 1346028C1  
CATERPILLAR 9T5916



H 1 : 240 (mm)  
OD 1 : 94.5 (mm)  
Thread Size : 1 3/8-12 UNF-2B

CONT : 12  
VOL : 0.036

Note : with Glass Fiber Media

384

**HC-56060** Hydraulic Oil Filter Spin-On

KOMATSU 418-18-34160



H 1 : 155 (mm)  
OD 1 : 82.5 (mm)  
ID 1 : 155 (mm)  
Thread Size : M45X1.5-6H  
Gasket Type : Round

CONT : 12  
VOL : 0.019

Note : for Komatsu Wheel Loader WA200-5

389

**HC-45050** Hydraulic Oil Filter Transmission Spin-On Synthetic Media

CASE-IH CNH 1302541  
CASE-IH CNH 181167A1  
CUMMINS 181167A1



H 1 : 152 (mm)  
OD 1 : 94.5 (mm)  
Thread Size : 13/16-16 UNF-2B  
Gasket Type : Round

CONT : 12  
VOL : 0.024

Note : Aluminium casting version

380

**HC-55220** Hydraulic Oil Filter Spin-On With Microfiber media

CATERPILLAR 1261815  
CHARLES MACHINE 159074



H 1 : 152 (mm)  
OD 1 : 94.5 (mm)  
Thread Size : 1 3/8-12 UNF-2B

CONT : 12  
VOL : 0.024

385

**HC-76080** Hydraulic Oil Filter Spin-On Synthetic Media

CASE 1266751H2  
CASE 294721A1  
J.C.BAMFORD 32905501  
NEW HOLLAND (CNH) 9821387  
JOHN DEERE AL77061



H 1 : 152 (mm)  
OD 1 : 94.5 (mm)  
Thread Size : 1 3/8-12 UNF-2B

CONT : 12  
VOL : 0.024

Note : with Glass Fiber Media

390

# Sakura Filter

# Technical Specification

**HC-76130** Hydraulic Oil Filter Transmission Spin-On With Microfiber media

ZF 0501323154  
J.C.BAMFORD 32925905  
CASE 8603535  
CASE 87519452  
JOHN DEERE AT336140



H 1 : 199 (mm)  
OD 1 : 94.5 (mm)  
Thread Size : 1 3/8-12 UNF-2B  
Thread Stud Size : M24X1.5

CONT : 12  
VOL : 0.024

391

**O-18051** Oil Filter By Pass Metal End Cap Element

NISSAN 15274-90226  
NISSAN 15274-90227  
NISSAN 15274-99126  
NISSAN 15274-99227



H 1 : 245 (mm)  
H 2 : 235 (mm)  
OD 1 : 130 (mm)  
OD 2 : 130 (mm)  
ID 1 : 15.5 (mm)  
ID 2 : 15.5 (mm)

CONT : 25  
VOL : 0.119

Note : Paper Protector

396

**O-5501** Oil Filter Full Flow Metal End Cap Element

CATERPILLAR 5S-0484  
CATERPILLAR 7M-3800



H 1 : 233 (mm)  
OD 1 : 97 (mm)  
OD 2 : 97 (mm)  
ID 1 : 42 (mm)  
ID 2 : 42 (mm)

CONT : 25  
VOL : 0.066

Note : Paper Protector

401

**HC-7901** Hydraulic Oil Filter Spin-On

INTERNATIONAL HARVESTER 075912103  
KOBELCO 2446U141S2



H 1 : 130 (mm)  
OD 1 : 93 (mm)  
Thread Size : 1 1/8-16 UNF-2B  
Gasket Type : Round

CONT : 12  
VOL : 0.020

Note : Seat assy zinc coating

392

**O-1809** Oil Filter Combination Metal End Cap Element

NISSAN 15274-90225  
NISSAN 15274-90228  
NISSAN 15274-90229



H 1 : 192 (mm)  
H 2 : 182 (mm)  
OD 1 : 100 (mm)  
OD 2 : 100 (mm)  
ID 1 : 40 (mm)  
ID 2 : 16.5 (mm)

CONT : 25  
VOL : 0.061

397

**O-5601** Oil Filter Full Flow Metal End Cap Element

KOMATSU 6110-53-5120  
KOMATSU 6114-50-5100  
KOMATSU 6120-50-5103



H 1 : 233.7 (mm)  
H 2 : 231.5 (mm)  
OD 1 : 100 (mm)  
OD 2 : 100 (mm)  
ID 1 : 42 (mm)  
ID 2 : 42 (mm)

CONT : 20  
VOL : 0.080

Note : Paper Protector

402

**HC-7906** Hydraulic Oil Filter Spin-On

J.C.BAMFORD 32/901701



H 1 : 178 (mm)  
OD 1 : 128.8 (mm)  
Thread Size : 1 1/4-11  
Gasket Type : Square

CONT : 6  
VOL : 0.028

393

**O-1901** Oil Filter Full Flow Metal End Cap Element

PERKINS 101606  
FORD 2701-E6731A



H 1 : 99 (mm)  
H 2 : 97 (mm)  
OD 1 : 97 (mm)  
OD 2 : 97 (mm)  
ID 1 : 34 (mm)  
ID 2 : 34 (mm)

CONT : 50  
VOL : 0.060

Note : Paper protector

398

**O-5603** Oil Filter Full Flow Metal End Cap Element

KOMATSU 6610-50-4400  
KOMATSU 6610-50-5100  
KOMATSU 6610-51-4400



H 1 : 237 (mm)  
H 2 : 231 (mm)  
OD 1 : 128 (mm)  
OD 2 : 128 (mm)  
ID 1 : 56.4 (mm)  
ID 2 : 56.4 (mm)

CONT : 25  
VOL : 0.128

Note : Paper Protector

403

**HC-7913** Hydraulic Oil Filter Spin-On

CLARK 234099  
CATERPILLAR 311980  
J.C.BAMFORD 4110147  
FIAT 906041007



H 1 : 140 (mm)  
OD 1 : 93.5 (mm)  
Thread Size : 2-16 UNF-2B  
Gasket Type : Square

CONT : 12  
VOL : 0.024

394

**O-1902** Oil Filter Full Flow Metal End Cap Element

MAZDA 0636-23-802  
MAZDA 0727-23-820A  
MERCURUISER 35-16595



H 1 : 114 (mm)  
H 2 : 112 (mm)  
OD 1 : 97 (mm)  
OD 2 : 97 (mm)  
ID 1 : 34 (mm)  
ID 2 : 34 (mm)

CONT : 50  
VOL : 0.066

Note : Paper protector

399

**O-5702** Oil Filter Full Flow Metal End Cap Element

CUMMINS 158139  
KOMATSU 6610-51-5100  
KOMATSU CULF-516



H 1 : 249 (mm)  
H 2 : 244.5 (mm)  
OD 1 : 126 (mm)  
OD 2 : 126 (mm)  
ID 1 : 39 (mm)  
ID 2 : 39 (mm)

CONT : 9  
VOL : 0.050

Note : Paper Protector

404

**O-1803** Oil Filter Full Flow Metal End Cap Element

NISSAN 15208-32200  
NISSAN 15208-32225  
INTERNATIONAL HARVESTER 3110452R91



H 1 : 141 (mm)  
H 2 : 137 (mm)  
OD 1 : 72.5 (mm)  
OD 2 : 72.5 (mm)  
ID 1 : 33 (mm)  
ID 2 : 33 (mm)

CONT : 50  
VOL : 0.051

Note : Paper Protector

395

**O-2619** Oil Filter Full Flow Metal End Cap Element

COMP AIR 1078A/06950



H 1 : 262 (mm)  
H 2 : 256 (mm)  
OD 1 : 90.5 (mm)  
OD 2 : 90.5 (mm)  
ID 1 : 50 (mm)  
ID 2 : 50 (mm)

CONT : 25  
VOL : 0.067

Note : Paper Protection

400

**O-5703** Oil Filter Full Flow Metal End Cap Element

FORD 1461524  
CUMMINS 173174  
FORD 68MF6731BAA



H 1 : 195 (mm)  
H 2 : 189 (mm)  
OD 1 : 121 (mm)  
OD 2 : 121 (mm)  
ID 1 : 38.5 (mm)  
ID 2 : 39 (mm)

CONT : 12  
VOL : 0.047

405



**Sakura Filter**

**Technical Specification**

**O-5704** Oil Filter By Pass Can-type Depth

CUMMINS 101855  
SUMITOMO 136750  
CUMMINS 256838

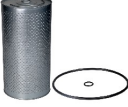

H 1 : 382 (mm)  
H 2 : 376 (mm)  
OD 1 : 197 (mm)  
OD 2 : 197 (mm)  
ID 1 : 22 (mm)  
ID 2 : 22 (mm)

CONT : 6  
VOL : 0.111

406

**SFC-1905-10** Fuel/Water Separator Secondary Spin-On 10 Micron

MASSEY-FERGUSON 108615W1  
BOMAG 31701062  
LIEBHERR 7364111  
KOBELCO YN02PU1010P1



H 1 : 169 (mm)  
H 2 : 156 (mm)  
OD 1 : 93 (mm)  
Thread Size : 1-14 UNS-2B  
Thread Nut Size : 1 1/4"X10 UNS-2B  
Gasket Type : Square

CONT : 12  
VOL : 0.026

Note : bowl not included

411

**SFC-5601-02** Fuel/Water Separator Spin-On High Efficiency

CUMMINS 3089916  
KOMATSU 600-311-3110  
KOMATSU 600-311-3111  
KOMATSU 600-319-3111A



H 1 : 311.4 (mm)  
H 2 : 286 (mm)  
OD 1 : 118 (mm)  
Thread Size : 1 1/4-12 UNF-2B

CONT : 6  
VOL : 0.039

Note : High efficiency filter for high pressure fuel injection systems

416

**O-5705** Oil Filter By Pass Can-type Depth

CUMMINS 256839



H 1 : 248 (mm)  
OD 1 : 196.5 (mm)  
OD 2 : 196.5 (mm)  
ID 1 : 27 (mm)  
ID 2 : 27 (mm)

CONT : 9  
VOL : 0.120

407

**SFC-19100** Fuel/Water Separator Spin-On

KOMATSU 600-311-3620  
KOMATSU 600-319-3610



H 1 : 169 (mm)  
H 2 : 156 (mm)  
OD 1 : 93 (mm)  
Thread Size : 1-14 UNS-2B  
Thread Nut Size : 1 1/4"X10 UNS-2A  
Gasket Type : Square

CONT : 12  
VOL : 0.030

Note : bowl not included

412

**SFC-56020** Fuel/Water Separator Spin-On 10 Micron

KOMATSU 600-311-3400  
KOMATSU 600-311-4510  
KOMATSU 600-311-4540  
KOBELCO LV21P01018P1-DK



H 1 : 255 (mm)  
OD 1 : 118 (mm)  
Thread Size : 1 1/4-12 UNF-2B  
Gasket Type : Square

CONT : 6  
VOL : 0.039

Note : For high pressure fuel injection systems suction side only

417

**O-6503** Oil Filter Full Flow Metal End Cap Element

GENERAL MOTORS 357304  
GENERAL MOTORS 5573014  
GENERAL MOTORS 5573102



H 1 : 231 (mm)  
H 2 : 227 (mm)  
OD 1 : 109.5 (mm)  
OD 2 : 109.5 (mm)  
ID 1 : 37 (mm)  
ID 2 : 37 (mm)

CONT : 12  
VOL : 0.043

Note : Metal Protector

408

**SFC-19100B** Fuel/Water Separator Spin-On With Bowl

KOMATSU 600-311-3620  
KOMATSU 600-319-3610  
KOMATSU 600-319-3620



H 1 : 198 (mm)  
H 2 : 156 (mm)  
OD 1 : 93 (mm)  
Thread Size : 1-14 UNS-2B  
Thread Nut Size : 1 1/4"X10 UNS-2A  
Gasket Type : Square

CONT : 12  
VOL : 0.049

Note : SFC-19100 and FB-19100

413

**SFC-56020B** Fuel/Water Separator Spin-On With Bowl 10 Micron

KOMATSU 600-319-4540



H 1 : 255 (mm)  
OD 1 : 118 (mm)  
Thread Size : 1 1/4-12 UNF-2B  
Gasket Type : Square

CONT : 6  
VOL : 0.038

Note : SFC-56020 and FB-1813

418

**O-7901** Oil Filter Full Flow Metal End Cap Element

PERKINS 30211  
CROSLAND 403  
GENERAL MOTORS 6435092



H 1 : 153 (mm)  
H 2 : 151 (mm)  
OD 1 : 73 (mm)  
OD 2 : 73 (mm)  
ID 1 : 37 (mm)  
ID 2 : 37 (mm)

CONT : 50  
VOL : 0.050

Note : Paper Protector

409

**SFC-45030** Fuel/Water Separator Spin-On With Drain

CUMMINS 2830348  
NEW HOLLAND (CNH) 87803192  
CASE-IH CNH 87803194



H 1 : 148 (mm)  
OD 1 : 76 (mm)  
Thread Size : M16X1.5-6H  
Gasket Type : Square

CONT : 12  
VOL : 0.019

414

**SFC-56040** Fuel/Water Separator Spin-On 10 Micron

CUMMINS 4941237  
KOMATSU 600-311-4120  
KOMATSU 600-319-4110



H 1 : 118.5 (mm)  
OD 1 : 93 (mm)  
Thread Size : M24X1.5-6H  
Gasket Type : Square

CONT : 12  
VOL : 0.022

Note : For high pressure fuel injection systems suction side only

419

**SF-52150** Fuel/Water Separator Metal End Cap Element

YANMAR 120324-55760



H 1 : 60 (mm)  
H 2 : 60 (mm)  
OD 1 : 73 (mm)  
OD 2 : 73 (mm)  
ID 1 : 11 (mm)  
ID 2 : 11 (mm)

CONT : 50  
VOL : 0.024

410

**SFC-5509-10** Fuel/Water Separator Spin-On 10 Micron

CUMMINS 3406889  
CUMMINS 3954891  
CUMMINS 3954904  
CUMMINS 4070801



H 1 : 211 (mm)  
OD 1 : 93 (mm)  
Thread Size : 1-14 UNS-2B  
Gasket Type : Square

CONT : 12  
VOL : 0.036

415

**SFC-56050** Fuel/Water Separator Spin-On High Efficiency

KOMATSU 600-319-5610



H 1 : 175 (mm)  
OD 1 : 136 (mm)  
Thread Size : M36X1.5-6H  
Gasket Type : Square

CONT : 6  
VOL : 0.027

Note : 10 micron, bowl not included

420

**SFC-56060** Fuel/Water Separator Spin-On  
KOMATSU 600-319-5910



H 1 : 165 (mm)  
H 2 : 147 (mm)  
OD 1 : 108 (mm)  
Thread Size : M36X1.5-6H

CONT : 12  
VOL : 0.032

Note : Komatsu Excavator PC60-8

**SFC-5707** Fuel/Water Separator Spin-On With Drain Plug  
MTU 0010925601  
CUMMINS 3309437  
CUMMINS 3313304  
HITACHI 4202934



H 1 : 311.4 (mm)  
H 2 : 286 (mm)  
OD 1 : 115.5 (mm)  
Thread Size : 1 1/4-12 UNF-2B  
Gasket Type : Square

CONT : 6  
VOL : 0.036

**WC-56010** Coolant Filter Spin-On  
KOMATSU 600-411-1171  
KOBELCO LV52V01002P1

H 1 : 200.4 (mm)  
OD 1 : 108 (mm)  
Thread Size : 11/16-16 UNF-2B  
Gasket Type : Square

CONT : 6  
VOL : 0.020

**SFC-5611-10** Fuel/Water Separator Secondary Spin-On 10 Micron  
KOMATSU 600-311-3410  
KOMATSU 600-319-3240A



H 1 : 255 (mm)  
OD 1 : 118 (mm)  
Thread Size : 1 1/4-12 UNF-2B  
Gasket Type : Square

CONT : 6  
VOL : 0.032

Note : For high pressure fuel injection systems suction side only

**SFC-5708** Fuel/Water Separator Spin-On  
CUMMINS 3286503  
CUMMINS 3843760  
CUMMINS 3903202



H 1 : 140 (mm)  
OD 1 : 76 (mm)  
Thread Size : M16X1.5-6H

CONT : 25  
VOL : 0.033

Note : with drain plug

**WC-5703** Coolant Filter Spin-On  
CUMMINS 3318319  
HITACHI 4266063  
KOMATSU 6742-01-3490

H 1 : 136 (mm)  
OD 1 : 93 (mm)  
Thread Size : 11/16-16 UNF-2B  
Gasket Type : Square

CONT : 12  
VOL : 0.020

Note : Coolants = 23 units

**SFC-5611-10B** Fuel/Water Separator Secondary Spin-On With Bowl 10 Micron  
KOMATSU 600-311-3410  
KOMATSU 600-319-3240A



H 1 : 345 (mm)  
H 2 : 255 (mm)  
OD 1 : 118 (mm)  
Thread Size : 1 1/4-12 UNF-2B  
Gasket Type : Square

CONT : 6  
VOL : 0.039

Note : For high pressure fuel injection systems suction side only

**SFC-5709-10** Fuel/Water Separator Spin-On 10 Micron  
CATERPILLAR 256-8753  
CUMMINS 3329289  
HITACHI 4377880



H 1 : 245 (mm)  
OD 1 : 93 (mm)  
Thread Size : 1-14 UNS-2B  
Gasket Type : Square

CONT : 6  
VOL : 0.019

**WC-5705** Coolant Filter Spin-On  
CUMMINS 299080  
CUMMINS 3100304  
CUMMINS 3305367

H 1 : 100 (mm)  
OD 1 : 93 (mm)  
Thread Size : 11/16-16 UNF-2B  
Gasket Type : Square

CONT : 12  
VOL : 0.018

Note : Coolants = 4 units

**SFC-5705** Fuel/Water Separator Spin-On  
ISUZU 1-13240044-1  
CUMMINS 3308638  
CUMMINS 3315843  
SUNWARD 750201011130



H 1 : 174 (mm)  
OD 1 : 93 (mm)  
Thread Size : 1-14 UNS-2B  
Gasket Type : Square

CONT : 12  
VOL : 0.026

**SFC-7301** Fuel/Water Separator Spin-On  
GENERAL MOTORS 25312317



H 1 : 191 (mm)  
OD 1 : 93 (mm)  
Thread Size : 1-12 UNF-2B  
Gasket Type : Square

CONT : 12  
VOL : 0.033

**WC-5706** Coolant Filter Spin-On  
KOMATSU 600-411-1140  
KOMATSU 600-411-1191

H 1 : 100 (mm)  
OD 1 : 93 (mm)  
Thread Size : 11/16-16 UNF-2B  
Gasket Type : Square

CONT : 12  
VOL : 0.018

Note : Coolants = 6 units

**SFC-5706** Fuel/Water Separator Spin-On  
J.C.BAMFORD 02/910150  
J.C.BAMFORD 02/910150A  
HYUNDAI 11E1-70210  
CUMMINS 3935274  
LIUGONG 53C0051



H 1 : 163.7 (mm)  
H 2 : 134 (mm)  
OD 1 : 93 (mm)  
OD 2 : 92.7 (mm)  
Thread Size : 13/16-18 UNF-2B  
Thread Nut Size : M14X2  
Gasket Type : Square

CONT : 12  
VOL : 0.021

**TC-56010** Oil Filter Transmission Spin-On With Removal Nut  
KAWASAKI 31115-70010  
KOMATSU 714-07-28711  
KOMATSU 714-07-28712  
KOMATSU 714-07-28713



H 1 : 260 (mm)  
H 2 : 248 (mm)  
OD 1 : 106 (mm)  
Thread Size : M60X2-6H  
Gasket Type : Square

CONT : 6  
VOL : 0.047

**WC-5707** Coolant Filter Spin-On  
INGERSOLL RAND 35357276  
KOMATSU 600-411-1180  
KOMATSU 6134-61-8110  
KOMATSU 6710-61-8110

H 1 : 135 (mm)  
OD 1 : 93 (mm)  
Thread Size : 11/16-16 UNF-2B  
Gasket Type : Square

CONT : 12  
VOL : 0.020

Note : Coolants = 8 units

**WC-5708** Coolant Filter Spin-On

GENERAL MOTORS 23507189  
 FIAT 4393504  
 CASE 441365C1



H 1 : 136 (mm)  
 OD 1 : 93 (mm)  
 Thread Size : 11/16-16 UNF-2B  
 Gasket Type : Square

CONT : 12  
 VOL : 0.027

Note : Coolant = 15 units

436

**WC-5711** Coolant Filter Spin-On

CUMMINS 3315115  
 CUMMINS 3316462  
 CUMMINS 4058964



H 1 : 100 (mm)  
 OD 1 : 93 (mm)  
 Thread Size : 11/16-16 UNF-2B  
 Gasket Type : Square

CONT : 12  
 VOL : 0.014

Note : Coolants = 8 units

437

**WC-5712** Coolant Filter Spin-On

CUMMINS 3100307  
 CUMMINS 3315114  
 CUMMINS 3316053



H 1 : 135 (mm)  
 OD 1 : 93 (mm)  
 Thread Size : 11/16-16 UNF-2B  
 Gasket Type : Square

CONT : 12  
 VOL : 0.020

Note : Coolants = 12 units

438

**WC-5713** Coolant Filter Spin-On

HITACHI 4228689  
 INGERSOLL RAND 57165805



H 1 : 136 (mm)  
 OD 1 : 93 (mm)  
 Thread Size : 11/16-16 UNF-2B  
 Gasket Type : Square

CONT : 12  
 VOL : 0.022

Note : Coolants = 15 units

439

**WC-6901** Coolant Filter Spin-On

CUMMINS 3305371  
 INGERSOLL RAND 56985971



H 1 : 189 (mm)  
 OD 1 : 93 (mm)  
 Thread Size : 11/16-16 UNF-2B  
 Gasket Type : Square

CONT : 12  
 VOL : 0.036

Note : Coolants = 23 units

440