

# VECTOR

PREMIUM QUALITY  
FILTERS



## KOREAN

### HEAVY DUTY SUB-CATALOG





# Table of Contents

DAEWU	.....	1
DOOSAN	.....	2
HYUNDAI	.....	3
SAMSUNG	.....	4

**DAEWO**

**1**

# Engine Application

A

# Sakura Filter

# ENGINE APPLICATION

MODEL/APPLICATION	SAKURA NO	MODEL/APPLICATION	SAKURA NO	MODEL/APPLICATION	SAKURA NO
<b>DAEWOO</b>		<b>DAEWOO</b>		<b>DAEWOO</b>	
<b>1340XL</b> (LOADERS) YANMAR 4TNE84		Air Filter Secondary.....	A-6008	<b>DH210W/V</b> (EXCAVATORS)	
Fuel Filter.....	F-5210	Air Filter Primary.....	A-5627	Hydraulic Oil Filter.....	H-2704
<b>170 5 SERIES</b> (LOADERS) 170 5 SERIES		Hydraulic Oil Filter.....	H-2704	<b>DH220ED</b> (EXCAVATORS)	
Air Filter Secondary.....	A-5635	<b>DH130-II</b> (EXCAVATORS)		Air Filter Primary.....	A-7954
Fuel/Water Separator.....	SFC-5705	Air Filter Secondary.....	A-6008	Fuel Filter.....	F-2622
Hydraulic Oil Filter.....	H-7923	Air Filter Set.....	A-5663-S	Fuel Filter.....	F-2621
<b>170 5 SERIES</b> (LOADERS)		Air Filter Primary.....	A-5627	Fuel Filter.....	F-2601
Air Filter Secondary.....	A-5635	Hydraulic Oil Filter.....	H-2704	Hydraulic Oil Filter.....	H-2704
Air Filter Set.....	A-5654-S	<b>DH130W</b> (EXCAVATORS)		Oil Filter Full Flow.....	C-8901
Air Filter Primary.....	A-5639	Air Filter Secondary.....	A-6008	<b>DH220LC</b> (EXCAVATORS)	
Fuel/Water Separator.....	SFC-5705	Air Filter Set.....	A-5663-S	Air Filter Set.....	A-5663-S
Hydraulic Oil Filter.....	H-7911	Air Filter Primary.....	A-5627	Air Filter Primary.....	AS-1024
Oil Filter Full Flow.....	C-5611	Hydraulic Oil Filter.....	H-2704	Air Filter Set.....	AS-1024-S
<b>300LC-V</b> (EXCAVATORS) DAEWOO DE12T		<b>DH170</b> (EXCAVATORS) PERKINS 1006-6 6HR		Air Filter Primary.....	A-5627
Air Filter Secondary.....	A-89060	Air Filter Secondary.....	A-6008	Air Filter Secondary.....	A-6009
<b>340LC-V</b> (EXCAVATORS) DAEWOO DE12TIS		Air Filter Set.....	A-5663-S	Fuel Filter.....	F-2622
Air Filter Secondary.....	A-89060	Air Filter Primary.....	A-5627	Fuel Filter.....	F-2601
<b>450</b> (LOADERS) CUMMINS B3.3 , 2004-UP		Fuel Filter.....	FC-5103	Fuel Filter.....	F-2621
Air Filter Set.....	A-76410-S	Hydraulic Oil Filter.....	H-2704	Hydraulic Oil Filter.....	H-2704
Air Filter Secondary.....	A-8599	Oil Filter Full Flow.....	C-5102	<b>DH280</b> (EXCAVATORS) DAEWOO D2366	
Air Filter.....	A-76410	<b>DH180LC</b> (EXCAVATORS) RENAULTV D0846 HM		Air Filter Primary.....	A-2210
<b>450 PLUS</b> (LOADERS) CUMMINS B3.3 , 2004-UP		Air Filter Secondary.....	A-6009	Fuel Filter.....	F-2604
Oil Filter Full Flow.....	C-56191	Air Filter Primary.....	AS-1024	Fuel Filter.....	F-2603
<b>460</b> (LOADERS) CUMMINS B3.3 , 2004-UP		Air Filter Set.....	AS-1024-S	Hydraulic Oil Filter.....	H-2704
Air Filter Set.....	AS-9231-S	Hydraulic Oil Filter.....	H-2704	Hydraulic Oil Filter.....	H-89030
Air Filter Secondary.....	A-5016	<b>DH150LC-7</b> (EXCAVATORS) DAEWOO DB58TIS		Oil Filter Full Flow.....	C-7942
Air Filter Primary.....	AS-9231	Hydraulic Oil Filter.....	H-89030	<b>DH280ED</b> (EXCAVATORS)	
<b>460</b> (LOADERS) CUMMINS B3.3 , 2004		<b>DH150W-7</b> (EXCAVATORS) DAEWOO DB58TIS		Air Filter Secondary.....	A-7619
Air Filter Secondary.....	A-5016	Hydraulic Oil Filter.....	H-89030	Fuel Filter.....	F-2604
<b>470 PLUS</b> (LOADERS) CUMMINS B3.3T , 2004-UP		<b>DH200LC</b> (EXCAVATORS) RENAULTV D0846 HM		Fuel Filter.....	F-2603
Oil Filter Full Flow.....	C-56191	Air Filter Primary.....	AS-1024	Hydraulic Oil Filter.....	H-2704
<b>D40S</b> (FORKLIFTS) PERKINS , 1995-UP		Air Filter Secondary.....	A-6009	Oil Filter Full Flow.....	C-7942
Air Filter Primary.....	A-5537	Air Filter Set.....	AS-1024-S	<b>DH220</b> (EXCAVATORS)	
Air Filter Set.....	A-5537-S	Fuel Filter.....	F-2601	Hydraulic Oil Filter.....	H-2704
Air Filter Secondary.....	A-5536	Fuel Filter.....	F-2622	<b>DH215-9</b> (EXCAVATORS)	
<b>DH130</b> (EXCAVATORS) ISUZU 6BB1		Fuel Filter.....	F-2621	Cabin Air Filter.....	CA-89100
Air Filter Primary.....	AS-7805	Hydraulic Oil Filter.....	H-2704	<b>DH220-9</b> (EXCAVATORS)	
Air Filter Secondary.....	A-7806	<b>DH200W</b> (EXCAVATORS) DAEWOO D1146		Cabin Air Filter.....	CA-89100
Air Filter Set.....	AS-5656-S	Air Filter Secondary.....	A-6009	<b>DH225-9</b> (EXCAVATORS)	
Hydraulic Oil Filter.....	H-2704	Air Filter Secondary.....	A-6008	Cabin Air Filter.....	CA-89100
<b>DH130-2</b> (EXCAVATORS) DAEWOO DB58		Air Filter Set.....	AS-1024-S	<b>DH215-7</b> (EXCAVATORS) DAEWOO DB58TI	
Air Filter Set.....	A-5663-S	Air Filter Primary.....	A-5627	Hydraulic Oil Filter.....	H-89030
		Air Filter Set.....	A-5663-S	<b>DH220LC-7</b> (EXCAVATORS) DAEWOO DB58TI	
		Air Filter Primary.....	AS-1024	Hydraulic Oil Filter.....	H-89030
		Fuel Filter.....	F-2601		
		Fuel Filter.....	F-2621		
		Fuel Filter.....	F-2622		
		Hydraulic Oil Filter.....	H-2704		

MODEL/APPLICATION	SAKURA NO	MODEL/APPLICATION	SAKURA NO	MODEL/APPLICATION	SAKURA NO
<b>DAEWOO</b>					
DH225LC-7 (EXCAVATORS) DAEWOO DB58TIS		DX140W-3 (EXCAVATORS) DOOSAN DL06K 0 , 2012		Air Filter Primary.....	AS-1024
Hydraulic Oil Filter.....	H-89030	Hydraulic Oil Filter Pilot.....	H-89050	Air Filter Secondary.....	A-6009
DH258LC-7 (EXCAVATORS) DAEWOO DE08TIS		DX160LC (EXCAVATORS) DOOSAN DL06 0 , 2008		Hydraulic Oil Filter.....	H-2704
Hydraulic Oil Filter.....	H-89030	Hydraulic Oil Filter Pilot.....	H-89050	<b>MEGA 200-III (LOADERS)</b>	
DH320 (EXCAVATORS) DAEWOO D2366		DX160W-3 (EXCAVATORS) DOOSAN 0 , 2013		Hydraulic Oil Filter.....	H-2704
Air Filter Primary.....	A-2210	Hydraulic Oil Filter Pilot.....	H-89050	<b>MEGA 200TC-V (LOADERS) 2004-UP</b>	
Fuel Filter.....	F-2604	DX170 (EXCAVATORS) DOOSAN 0 , 2012		Fuel/Water Separator.....	SFC-5705
Fuel Filter.....	F-2603	Hydraulic Oil Filter Pilot.....	H-89050	<b>MEGA 300 (LOADERS) DAEWOO D2366T , 2004-UP</b>	
Hydraulic Oil Filter.....	H-2704	DX210W (EXCAVATORS) DOOSAN DL06 0 , 2007		Air Filter Primary.....	A-2210
Oil Filter Full Flow.....	C-7942	Hydraulic Oil Filter Pilot.....	H-89050	Fuel Filter.....	F-2604
DH320 (EXCAVATORS) DAEWOO D2366T		DX300LC (EXCAVATORS) DOOSAN DL08 , 2005-UP		Fuel Filter.....	F-2603
Hydraulic Oil Filter.....	H-89030	Air Filter Primary.....	AS-8579	Hydraulic Oil Filter.....	H-2704
DH450 (EXCAVATORS) DAEWOO D2848T		Air Filter Primary.....	AS-8579M	<b>MEGA 300 (LOADERS) DAEWOO DE12T , 2004-UP</b>	
Fuel Filter.....	F-2603	Air Filter Set.....	AS-8579-S	Fuel/Water Separator.....	SFC-5701-10
Fuel Filter.....	F-2604	Air Filter Secondary.....	A-8580	<b>MEGA 300 (LOADERS)</b>	
Hydraulic Oil Filter.....	H-2704	Fuel/Water Separator.....	SFC-7939-30	Air Filter Primary.....	A-2210
Hydraulic Oil Filter.....	H-7911	Fuel/Water Separator.....	SFC-7939-30B	Fuel Filter.....	F-2604
DH50 (EXCAVATORS) DAEWOO DC24		Hydraulic Oil Filter.....	H-2719	Fuel Filter.....	F-2603
Air Filter Primary.....	AS-1014	DX75 (EXCAVATORS) YANMAR 4TNV94		Hydraulic Oil Filter.....	H-2704
Fuel Filter.....	FC-1007	Fuel Filter Primary.....	FC-52030	<b>MEGA 400 (LOADERS)</b>	
DH60-7 (EXCAVATORS) YANMAR 4TNV49L		G20E-3 (FORKLIFTS) DAEWOO G424		Air Filter Primary.....	A-2210
Fuel Filter Primary.....	FC-52030	Air Filter Secondary.....	A-8599	Fuel Filter.....	F-2604
DH80-7 (EXCAVATORS) YANMAR 4TNV98L		Air Filter Set.....	A-76410-S	Fuel Filter.....	F-2603
Fuel Filter Primary.....	FC-52030	Air Filter.....	A-76410	Hydraulic Oil Filter.....	H-2704
Hydraulic Oil Filter.....	H-89030	G20S-2 (FORKLIFTS) HERCULES 1404 2.7L		<b>MEGA 400-3 (LOADERS)</b>	
DSL601 (LOADERS) YANMAR 4TNE84		Oil Filter Full Flow.....	C-5504	Air Filter Secondary.....	A-5408
Air Filter Set.....	AS-9231-S	G255 (FORKLIFTS)		Air Filter Primary.....	A-6113
Air Filter Primary.....	AS-9231	Air Filter Primary.....	A-5537	Fuel/Water Separator.....	SFC-5705
Air Filter Secondary.....	A-5016	Air Filter Secondary.....	A-5536	Hydraulic Oil Filter.....	HC-6802
Oil Filter Full Flow.....	C-1011	Air Filter Set.....	A-5537-S	Hydraulic Oil Filter.....	H-7911
DSL602 (LOADERS) YANMAR 4TNE84		M400 (LOADERS)		Oil Filter Full Flow.....	C-7942
Air Filter Secondary.....	A-5016	Hydraulic Oil Filter.....	H-2704	<b>MEGA 400V (LOADERS) DAEWOO DE12T</b>	
DSL702 (LOADERS)		MEGA 500 (LOADERS) CUMMINS QSM11		Fuel/Water Separator.....	SFC-5701-10
Air Filter.....	A-76410	Coolant Filter.....	WC-5705	Hydraulic Oil Filter.....	H-7911
Air Filter Set.....	A-76410-S	Fuel/Water Separator.....	SFC-5709-10	<b>MEGA 250 (LOADERS)</b>	
DX140W (EXCAVATORS) DOOSAN 0 -2009		MEGA 500-V (LOADERS) CUMMINS QSM11		Hydraulic Oil Filter Transmission..	HC-76130
Hydraulic Oil Filter Pilot.....	H-89050	Coolant Filter.....	WC-5713	<b>MEGA 400-III (LOADERS) DAEWOO D2366T</b>	
DX140LC (EXCAVATORS) DOOSAN DL06 0 , 2008		Fuel/Water Separator.....	SFC-5509-10	Hydraulic Oil Filter.....	HC-5503
Hydraulic Oil Filter Pilot.....	H-89050	Fuel/Water Separator.....	SFC-5709-10	<b>MK111 S 220 (LOADERS)</b>	
DX190W (EXCAVATORS) DOOSAN DL06 0 , 2007		MEGA 200 (LOADERS) DAEWOO DB58T , 2004-UP		Hydraulic Oil Filter.....	H-2704
Hydraulic Oil Filter Pilot.....	H-89050	Air Filter Set.....	AS-1024-S	<b>RACER (EXCAVATORS)</b>	
				Oil Filter Full Flow.....	C-6701
				<b>S220LC-III (EXCAVATORS)</b>	

MODEL/APPLICATION	SAKURA NO	MODEL/APPLICATION	SAKURA NO	MODEL/APPLICATION	SAKURA NO
<b>DAEWOO</b>		<b>DAEWOO</b>		<b>DAEWOO</b>	
<b>S220LC-III</b> (EXCAVATORS)		Air Filter Set.....	A-5663-S	Hydraulic Oil Filter.....	H-2704
Air Filter Primary.....	A-5627	Air Filter Secondary.....	A-6008	Oil Filter Full Flow.....	C-8901
Air Filter Secondary.....	A-6008	Air Filter Primary.....	A-5627	<b>SOLAR 170W-III</b> (EXCAVATORS) DAEWOO D1146 0	
Air Filter Set.....	A-5663-S	Oil Filter Full Flow.....	C-5611	Hydraulic Oil Filter Pilot.....	H-89050
Fuel Filter.....	F-2622	<b>SOLAR 130LCV</b> (EXCAVATORS) DAEWOO DB58T		<b>SOLAR 170WV</b> (EXCAVATORS) DAEWOO DB58TI	
Fuel Filter.....	F-2621	Air Filter Set.....	A-5654-S	Air Filter Secondary.....	A-5635
Fuel Filter.....	F-2601	Air Filter Primary.....	A-5639	Air Filter Set.....	A-5654-S
Hydraulic Oil Filter.....	H-2704	Oil Filter Full Flow.....	C-5611	Air Filter Primary.....	A-5639
Oil Filter Full Flow.....	C-8901	<b>SOLAR 130V</b> (EXCAVATORS)		Hydraulic Oil Filter.....	H-7911
<b>S330</b> (EXCAVATORS)		Hydraulic Oil Filter.....	H-2704	Oil Filter Full Flow.....	C-5611
Air Filter Secondary.....	A-6008	<b>SOLAR 130W</b> (EXCAVATORS)		<b>SOLAR 170WV</b> (EXCAVATORS) DAEWOO DB58T 0	
Air Filter Primary.....	A-2210	Air Filter Primary.....	A-5627	Hydraulic Oil Filter Pilot.....	H-89050
<b>S330-III</b> (EXCAVATORS)		Air Filter Secondary.....	A-6008	<b>SOLAR 180WV</b> (EXCAVATORS) DAEWOO 0 , 2005	
Air Filter Primary.....	A-2210	Air Filter Set.....	A-5663-S	Hydraulic Oil Filter Pilot.....	H-89050
Fuel Filter.....	F-2603	Hydraulic Oil Filter.....	H-2704	<b>SOLAR 200V</b> (EXCAVATORS)	
Fuel Filter.....	F-2604	<b>SOLAR 130W-III</b> (EXCAVATORS) DAEWOO DB58T		Air Filter Secondary.....	A-5635
Hydraulic Oil Filter.....	H-7911	Air Filter Primary.....	A-5627	Air Filter Set.....	A-5654-S
Oil Filter Full Flow.....	C-7942	Air Filter Secondary.....	A-6008	Air Filter Primary.....	A-5639
<b>S400LC-III</b> (EXCAVATORS)		Air Filter Set.....	A-5663-S	<b>SOLAR 200W-III</b> (EXCAVATORS) DAEWOO D1146	
Air Filter Primary.....	A-2210	Hydraulic Oil Filter.....	H-2704	Air Filter Primary.....	A-5627
Fuel Filter.....	F-2604	<b>SOLAR 130W-III</b> (EXCAVATORS) DAEWOO DB58T 0		Air Filter Secondary.....	A-6008
Fuel Filter.....	F-2603	Hydraulic Oil Filter Pilot.....	H-89050	Air Filter Set.....	A-5663-S
Hydraulic Oil Filter.....	H-7911	<b>SOLAR 140WV</b> (EXCAVATORS) DOOSAN DB58TS 0		Fuel Filter.....	F-2621
Oil Filter Full Flow.....	C-7942	Hydraulic Oil Filter Pilot.....	H-89050	Fuel Filter.....	F-2601
<b>S450-III</b> (EXCAVATORS)		<b>SOLAR 170-III</b> (EXCAVATORS) DAEWOO DB58T		Fuel Filter.....	F-2622
Air Filter Primary.....	A-89050	Air Filter Secondary.....	A-6008	Hydraulic Oil Filter.....	H-2704
Air Filter Set.....	A-89050-S	Air Filter Set.....	A-5663-S	<b>SOLAR 200W-III</b> (EXCAVATORS) DAEWOO D1146 0	
Fuel Filter.....	F-2604	Air Filter Primary.....	A-5627	Hydraulic Oil Filter Pilot.....	H-89050
Fuel Filter.....	F-2603	Fuel Filter.....	F-2601	<b>SOLAR 200WV</b> (EXCAVATORS) DAEWOO DB58TI	
Hydraulic Oil Filter.....	H-7911	Fuel Filter.....	F-2622	Air Filter Primary.....	A-5639
Oil Filter Full Flow.....	C-8901	Fuel Filter.....	F-2621	Air Filter Secondary.....	A-5635
<b>SOLAR 015</b> (EXCAVATORS) ISUZU 3KR1		Hydraulic Oil Filter.....	H-2704	Air Filter Set.....	A-5654-S
Air Filter Primary.....	AS-1014	Hydraulic Oil Filter.....	H-7911	Hydraulic Oil Filter.....	H-7911
<b>SOLAR 025</b> (EXCAVATORS) ISUZU 3KR1		Hydraulic Oil Filter.....	H-2719	Oil Filter Full Flow.....	C-5611
Air Filter Primary.....	AS-1014	Oil Filter Full Flow.....	C-8901	Oil Filter Full Flow.....	C-5611
<b>SOLAR 035</b> (EXCAVATORS) ISUZU 3LD1		Oil Filter Full Flow.....	C-5611	<b>SOLAR 200WV</b> (EXCAVATORS) DOOSAN 0 , 2004	
Air Filter Primary.....	AS-1014	<b>SOLAR 170LCV</b> (EXCAVATORS) DAEWOO DB58T		Hydraulic Oil Filter Pilot.....	H-89050
<b>SOLAR 035</b> (EXCAVATORS) ISUZU 3KR1		Fuel/Water Separator.....	SFC-5701-10	<b>SOLAR 210WV</b> (EXCAVATORS) DAEWOO DB58TI5 0 , 2006	
Air Filter Primary.....	AS-1014	Hydraulic Oil Filter.....	H-7911	Hydraulic Oil Filter Pilot.....	H-89050
<b>SOLAR 050</b> (EXCAVATORS) DAEWOO DC24		Oil Filter Full Flow.....	C-5611	<b>SOLAR 220</b> (EXCAVATORS) DAEWOO D1146	
Air Filter Set.....	AS-1024-S	<b>SOLAR 170W-III</b> (EXCAVATORS) DAEWOO D1146N		Air Filter Secondary.....	A-6009
Air Filter Secondary.....	A-6009	Air Filter Secondary.....	A-6008	Air Filter Set.....	AS-1024-S
Air Filter Primary.....	AS-1024	Air Filter Set.....	A-5663-S	Air Filter Primary.....	AS-1024
Fuel Filter.....	F-2604	Air Filter Primary.....	A-5627	<b>SOLAR 220III</b> (EXCAVATORS)	
<b>SOLAR 130</b> (EXCAVATORS) DAEWOO DB58		Fuel Filter.....	F-2621	Hydraulic Oil Filter.....	H-2704
Air Filter Set.....	AS-1024-S	Fuel Filter.....	F-2601		
Air Filter Secondary.....	A-6009	Fuel Filter.....	F-2622		
Air Filter Primary.....	AS-1024	Fuel/Water Separator.....	SFC-5701-10		
Fuel Filter.....	F-2604				

MODEL/APPLICATION	SAKURA NO	MODEL/APPLICATION	SAKURA NO
<b>DAEWOO</b>		<b>DAEWOO</b>	
<b>SOLAR 220LCIII (EXCAVATORS) DAEWOO D1146</b>		<b>SOLAR 450 (EXCAVATORS) DAEWOO DV15T</b>	
Air Filter Set.....	A-5663-S	Air Filter Primary.....	AS-1024
Air Filter Secondary.....	A-6008	Air Filter Secondary.....	A-6009
Air Filter Primary.....	A-5627	Air Filter Set.....	AS-1024-S
Fuel Filter.....	F-2601	Fuel Filter.....	F-2604
Fuel Filter.....	F-2622	<b>SOLAR 55 (EXCAVATORS) ISUZU A-43B1</b>	
Fuel Filter.....	F-2621	Air Filter Primary.....	AS-1014
Hydraulic Oil Filter.....	H-2704	Fuel Filter.....	FC-1801
Oil Filter Full Flow.....	C-8901	Oil Filter Full Flow.....	C-1538
<b>SOLAR 220V (EXCAVATORS)</b>		Oil Filter Full Flow.....	C-1511
Hydraulic Oil Filter.....	H-2704	<b>SOLAR 70 III (EXCAVATORS)</b>	
<b>SOLAR 280 (EXCAVATORS)</b>		Hydraulic Oil Filter.....	H-2704
Air Filter Primary.....	A-2210	Oil Filter Full Flow.....	C-5611
Fuel Filter.....	F-2604	<b>SOLAR LC320 (EXCAVATORS) DAEWOO D1146TI</b>	
<b>SOLAR 280LC-III (EXCAVATORS) DAEWOO D2366</b>		Fuel Filter.....	F-2603
Air Filter Secondary.....	A-6008	Hydraulic Oil Filter.....	H-2704
Air Filter Primary.....	A-2210	<b>SOLAR 400LC-V (EXCAVATORS) DAEWOO DE12</b>	
Fuel Filter.....	F-2604	Hydraulic Oil Filter.....	H-2719
Fuel Filter.....	F-2603	<b>SOLAR 290LCV (EXCAVATORS) DAEWOO D1146TI</b>	
Hydraulic Oil Filter.....	H-7911	Air Filter Set.....	A-89050-S
Oil Filter Full Flow.....	C-7942	Air Filter Primary.....	A-89050
<b>SOLAR 290LL (EXCAVATORS) DAEWOO D1146T</b>		Hydraulic Oil Filter.....	H-2709
Fuel Filter.....	F-2603	<b>SOLAR 290LL (EXCAVATORS) DAEWOO D1146T</b>	
Hydraulic Oil Filter.....	H-2704	Fuel Filter.....	F-2603
<b>SOLAR 300LCV (EXCAVATORS) DAEWOO , 2005-UP</b>		Hydraulic Oil Filter.....	H-2704
Air Filter Primary.....	A-89050	<b>SOLAR 300LCV (EXCAVATORS) DAEWOO , 2005-UP</b>	
Air Filter Set.....	A-89050-S	Air Filter Primary.....	A-89050
Fuel/Water Separator.....	SFC-5705	Air Filter Set.....	A-89050-S
Fuel/Water Separator.....	SFC-5701-10	Fuel/Water Separator.....	SFC-5705
Hydraulic Oil Filter.....	H-2709	Hydraulic Oil Filter.....	H-2709
Hydraulic Oil Filter.....	H-2719	<b>SOLAR 330 (EXCAVATORS) DAEWOO DE12T</b>	
<b>SOLAR 330 (EXCAVATORS) DAEWOO DE12T</b>		Air Filter Set.....	AS-1024-S
Air Filter Set.....	AS-1024-S	Air Filter Primary.....	AS-1024
Air Filter Primary.....	AS-1024	Air Filter Secondary.....	A-6009
Air Filter Secondary.....	A-6009	Fuel Filter.....	F-2604
Fuel Filter.....	F-2604	<b>SOLAR 340LCV (EXCAVATORS) DAEWOO DE12TIS (S/N: 1041-UP) , 2002-UP</b>	
<b>SOLAR 340LCV (EXCAVATORS) DAEWOO DE12TIS (S/N: 1041-UP) , 2002-UP</b>		Air Filter Primary.....	A-89050
Air Filter Primary.....	A-89050	Air Filter Set.....	A-89050-S
Air Filter Set.....	A-89050-S	Fuel/Water Separator.....	SFC-5705
Fuel/Water Separator.....	SFC-5705	Hydraulic Oil Filter.....	H-2719
Hydraulic Oil Filter.....	H-2719	<b>SOLAR 420LCV (EXCAVATORS) DAEWOO DE12TIS</b>	
<b>SOLAR 420LCV (EXCAVATORS) DAEWOO DE12TIS</b>		Fuel/Water Separator.....	SFC-5701-10
Fuel/Water Separator.....	SFC-5701-10		

















# Technical Specification

**B**



# Sakura Filter

# Technical Specification

<p><b>A-2210</b> Air Filter Primary Metal End Cap Element</p>  <p>FIAT 0068473-3 LOESING 021779 ISUZU 1-14215-018-0 ISUZU 1-14215007-0 NISSAN 16546-96011 Secondary Filter uses A-6008 Set Filter uses A-6117-S H 1 : 342.7 (mm) H 2 : 330 (mm) OD 1 : 234 (mm) OD 2 : 234 (mm) ID 1 : 123 (mm) ID 2 : 17 (mm)</p> <p>CONT : 4 VOL : 0.093</p>	<p><b>A-5537-S</b> Air Filter Set Soft PU end cap Element</p>  <p>CATERPILLAR 6I-1450+6I-1451</p> <p>Primary Filter uses A-5537 Secondary Filter uses A-5536 H 1 : 167 (mm) H 2 : 155 (mm) OD 1 : 207 (mm) OD 2 : 207 (mm) ID 1 : 105.5 (mm)</p> <p>CONT : 4 VOL : 0.041</p>	<p><b>A-5663-S</b> Air Filter Set Metal End Cap Element</p>  <p>KOMATSU 600-181-6050</p> <p>Primary Filter uses A-5627 Secondary Filter uses A-6008 H 1 : 380 (mm) H 2 : 330 (mm) OD 1 : 235 (mm) OD 2 : 187 (mm) ID 1 : 120 (mm) ID 2 : 17 (mm)</p> <p>CONT : 1 VOL : 0.030</p>
<p><b>A-5016</b> Air Filter Secondary Metal End Cap Element</p>  <p>FORD 272744 NELSON 70497N CASE D82775</p> <p>Primary Filter uses AS-9231 Set Filter uses AS-9231-S H 1 : 335.4 (mm) H 2 : 330 (mm) OD 1 : 115.5 (mm) OD 2 : 60.5 (mm) ID 1 : 48.5 (mm) ID 2 : 17 (mm)</p> <p>CONT : 9 VOL : 0.055</p>	<p><b>A-5627</b> Air Filter Primary Metal End Cap Element</p>  <p>KOBELCO 2451-U311-3 DAEWOO 2474-6006A DAEWOO 2474-6006B</p> <p>Secondary Filter uses A-6008 Set Filter uses A-5663-S H 1 : 394 (mm) H 2 : 381 (mm) OD 1 : 235 (mm) OD 2 : 187 (mm) ID 1 : 120 (mm) ID 2 : 17 (mm)</p> <p>CONT : 1 VOL : 0.026</p>	<p><b>A-6008</b> Air Filter Secondary Metal End Cap Element</p>  <p>LOESING 020940 ISUZU 1-14215047-0 ISUZU 1-1425-046-1 NISSAN 16546-96010</p> <p>Primary Filter uses A-5627 Set Filter uses A-5663-S H 1 : 330 (mm) OD 1 : 146 (mm) OD 2 : 116.5 (mm) ID 1 : 88 (mm) ID 2 : 17 (mm)</p> <p>CONT : 9 VOL : 0.083</p>
<p><b>A-5408</b> Air Filter Secondary Metal End Cap Element</p>  <p>LOESING 020939 ISUZU 1-14215034-0 ISUZU 1-14215036-0 NISSAN 16546-96014</p> <p>Primary Filter uses A-6113 Set Filter uses A-5653-S H 1 : 406 (mm) OD 1 : 192 (mm) OD 2 : 162.5 (mm) ID 1 : 134 (mm) ID 2 : 17 (mm)</p> <p>CONT : 9 VOL : 0.167</p> <p>Note : Is a Secondary Air filter for A-6113,A-54490</p>	<p><b>A-5635</b> Air Filter Secondary Metal End Cap Element</p>  <p>DAEWOO 2474-9054 KOMATSU 600-181-6730 MITSUBISHI ME033839</p> <p>Primary Filter uses A-5639 Set Filter uses A-5654-S H 1 : 415 (mm) H 2 : 402 (mm) OD 1 : 133.5 (mm) OD 2 : 133.5 (mm) ID 1 : 105 (mm) ID 2 : 17 (mm)</p> <p>CONT : 9 VOL : 0.086</p>	<p><b>A-6009</b> Air Filter Secondary Metal End Cap Element</p>  <p>LOESING 020941 NISSAN 16546-96004 KOBELCO 2451U206-3 KOMATSU 600-181-8360 ISUZU 9-14215017-0</p> <p>Primary Filter uses AS-1024 Set Filter uses AS-1024-S H 1 : 397 (mm) H 2 : 397 (mm) OD 1 : 146 (mm) OD 2 : 166.5 (mm) ID 1 : 88 (mm) ID 2 : 17 (mm)</p> <p>CONT : 9 VOL : 0.101</p>
<p><b>A-5536</b> Air Filter Secondary Soft PU end cap Element</p>  <p>CATERPILLAR 6I-1451</p> <p>Primary Filter uses A-5537 Set Filter uses A-5537-S H 1 : 148 (mm) H 2 : 144 (mm) OD 1 : 108 (mm) OD 2 : 101 (mm) ID 1 : 71 (mm)</p> <p>CONT : 25 VOL : 0.064</p>	<p><b>A-5639</b> Air Filter Primary Metal End Cap Element</p>  <p>KOBELCO 2451-U324-3 MITSUBISHI 3433000400</p> <p>Secondary Filter uses A-5635 Set Filter uses A-5654-S H 1 : 455 (mm) H 2 : 442 (mm) OD 1 : 263.5 (mm) OD 2 : 221 (mm) ID 1 : 136 (mm) ID 2 : 23 (mm)</p> <p>CONT : 1 VOL : 0.036</p>	<p><b>A-6113</b> Air Filter Primary Metal End Cap Element</p>  <p>FIAT 01901779 LOESING 022048 ISUZU 1-14215046-0 NISSAN 16546-96017</p> <p>Secondary Filter uses A-5408 Set Filter uses A-5653-S H 1 : 419 (mm) H 2 : 406 (mm) OD 1 : 282 (mm) OD 2 : 282 (mm) ID 1 : 171 (mm) ID 2 : 17 (mm)</p> <p>CONT : 1 VOL : 0.038</p>
<p><b>A-5537</b> Air Filter Primary Soft PU end cap Element</p>  <p>CATERPILLAR 6I-1450</p> <p>Secondary Filter uses A-5536 Set Filter uses A-5537-S H 1 : 167 (mm) H 2 : 155 (mm) OD 1 : 207 (mm) OD 2 : 207 (mm) ID 1 : 105.5 (mm)</p> <p>CONT : 4 VOL : 0.040</p>	<p><b>A-5654-S</b> Air Filter Set Metal End Cap Element</p>  <p>KOMATSU 600-181-6740</p> <p>Primary Filter uses A-5639 Secondary Filter uses A-5635 H 1 : 455 (mm) H 2 : 442 (mm) OD 1 : 263.5 (mm) OD 2 : 221 (mm) ID 1 : 135 (mm) ID 2 : 23 (mm)</p> <p>CONT : 1 VOL : 0.036</p>	<p><b>A-7619</b> Air Filter Secondary Metal End Cap Element</p>  <p>MASSEY-FERGUSON 3580724M1 LIEBHERR 7403951 JOHN DEERE RE42762</p> <p>Primary Filter uses AS-7621 Set Filter uses AS-7622-S H 1 : 394 (mm) H 2 : 381 (mm) OD 1 : 151 (mm) OD 2 : 151 (mm) ID 1 : 123 (mm) ID 2 : 17 (mm)</p> <p>CONT : 9 VOL : 0.120</p>



**A-76410** Air Filter Soft PU end cap Element



HYUNDAI 11FK-20080  
CASE 133720A1  
TOYOTA 17741U-2100-71  
LOESING 20666  
JOHN DEERE RE68043

H 1 : 312 (mm)  
H 2 : 304 (mm)  
OD 1 : 127.5 (mm)  
OD 2 : 127.5 (mm)  
ID 1 : 83 (mm)

CONT : 25  
VOL : 0.169

Note : Flame Retardant version of A-8505

**A-8599** Air Filter Secondary Soft PU end cap Element



KUBOTA 119005-12571  
CASE 133721A1  
HITACHI 4326841  
XCMG 819908758

Primary Filter uses A-8505  
Set Filter uses A-8602-S

H 1 : 303.5 (mm)  
H 2 : 298 (mm)  
OD 1 : 83 (mm)  
OD 2 : 79 (mm)  
ID 1 : 64 (mm)

CONT : 25  
VOL : 0.076

Note : Is a Secondary Air filter for A-5669,A-8505

**AS-1024** Air Filter Primary Metal End Cap Element With Sleeve



LOESING 020910  
NISSAN 16546-96003  
NISSAN 16546-96015  
NISSAN 16546-96026

Secondary Filter uses A-6009  
Set Filter uses AS-1024-S

H 1 : 419 (mm)  
H 2 : 406 (mm)  
OD 1 : 254 (mm)  
OD 2 : 201.5 (mm)  
ID 1 : 135.5 (mm)  
ID 2 : 17 (mm)

CONT : 1  
VOL : 0.031

**A-76410-S** Air Filter Set Soft PU end cap Element



CASE 133720A1+133721A1  
DAEWOO A213939+A213938  
JOHN DEERE RE68048+RE68049

Primary Filter uses A-76410  
Secondary Filter uses A-8599

H 1 : 312 (mm)  
H 2 : 304 (mm)  
OD 1 : 127.5 (mm)  
OD 2 : 127.5 (mm)  
ID 1 : 83 (mm)

CONT : 25  
VOL : 0.169

**A-89050** Air Filter Primary Metal End Cap Element



DAEWOO 2474-9051

Secondary Filter uses A-89060  
Set Filter uses A-89050-S

H 1 : 493 (mm)  
H 2 : 480 (mm)  
OD 1 : 276 (mm)  
OD 2 : 275 (mm)  
ID 1 : 165 (mm)  
ID 2 : 18 (mm)

CONT : 1  
VOL : 0.047

**AS-1024-S** Air Filter Set Metal End Cap Element With Sleeve



LOESING 020910+020941  
FIAT 1930751+1930790  
KOMATSU 6131-82-7011  
FIAT 70684732+1930790  
JOHN DEERE T46316+T46317

Primary Filter uses AS-1024  
Secondary Filter uses A-6009

H 1 : 419 (mm)  
H 2 : 406 (mm)  
OD 1 : 254 (mm)  
OD 2 : 201.5 (mm)  
ID 1 : 135.5 (mm)  
ID 2 : 17 (mm)

CONT : 1  
VOL : 0.031

**A-7806** Air Filter Secondary Metal End Cap Element



YANMAR 119131-12520  
ISUZU 14215-167  
DAEWOO 2474-9014

Primary Filter uses AS-7805  
Set Filter uses AS-5656-S

H 1 : 337 (mm)  
H 2 : 330 (mm)  
OD 1 : 85.5 (mm)  
OD 2 : 85.5 (mm)  
ID 1 : 57.5 (mm)  
ID 2 : 17 (mm)

CONT : 25  
VOL : 0.106

Note : Is a secondary Air Filter for AS-7805,AS-7813,A-7805

**A-89050-S** Air Filter Set Metal End Cap Element



DAEWOO 2474-9051+2474-9057

Primary Filter uses A-89050  
Secondary Filter uses A-89060

H 1 : 493 (mm)  
H 2 : 480 (mm)  
OD 1 : 276 (mm)  
OD 2 : 275 (mm)  
ID 1 : 134 (mm)  
ID 2 : 17 (mm)

CONT : 1  
VOL : 0.041

**AS-5656-S** Air Filter Set Metal End Cap Element With Sleeve



KOMATSU 600-181-9500

Primary Filter uses AS-7805  
Secondary Filter uses A-7806

H 1 : 392 (mm)  
H 2 : 381 (mm)  
OD 1 : 199 (mm)  
OD 2 : 155 (mm)  
ID 1 : 88 (mm)  
ID 2 : 17 (mm)

CONT : 9  
VOL : 0.169

**A-7954** Air Filter Primary Metal End Cap Element



ATLAS COPCO 3216-7082-01

Secondary Filter uses A-7809  
Set Filter uses A-7954-S

H 1 : 420 (mm)  
H 2 : 407 (mm)  
OD 1 : 234 (mm)  
OD 2 : 276 (mm)  
ID 1 : 122.5 (mm)  
ID 2 : 15 (mm)

CONT : 1  
VOL : 0.037

**A-89060** Air Filter Secondary Metal End Cap Element



DAEWOO 2474-9057

Primary Filter uses A-89050  
Set Filter uses A-89050-S

H 1 : 454 (mm)  
H 2 : 441 (mm)  
OD 1 : 162.5 (mm)  
OD 2 : 162.5 (mm)  
ID 1 : 134 (mm)  
ID 2 : 17 (mm)

CONT : 9  
VOL : 0.146

**AS-7805** Air Filter Primary Metal End Cap Element With Sleeve



IVECO 08014390  
MASSEY-FERGUSON 1093682M91

Secondary Filter uses A-7806  
Set Filter uses AS-5656-S

H 1 : 392 (mm)  
H 2 : 381 (mm)  
OD 1 : 199 (mm)  
OD 2 : 155 (mm)  
ID 1 : 88 (mm)  
ID 2 : 17 (mm)  
Gasket Type : Square

CONT : 9  
VOL : 0.169

Note : Long Life Versions Uses AS-7813

**A-8580** Air Filter Secondary Soft PU end cap Element



CATERPILLAR 142-1403  
ATLAS COPCO 3222-1881-92  
LIUGONG 40C0321  
HITACHI 4466268

Primary Filter uses A-8579  
Set Filter uses A-8579-S

H 1 : 500 (mm)  
H 2 : 494 (mm)  
OD 1 : 179 (mm)  
OD 2 : 174 (mm)  
ID 1 : 148 (mm)

CONT : 1  
VOL : 0.019

Note : Is a Secondary Air filter of A-8579M,A-8665M

**AS-1014** Air Filter Primary Metal End Cap Element With Sleeve



ISUZU 1-14215135-0  
TOYOTA 1001905  
YANMAR 171064-12540

Secondary Filter uses A-7919  
Set Filter uses AS-1014-S

H 1 : 288 (mm)  
H 2 : 279 (mm)  
OD 1 : 160 (mm)  
OD 2 : 134 (mm)  
ID 1 : 66.5 (mm)  
ID 2 : 17 (mm)

CONT : 9  
VOL : 0.090

**AS-8579** Air Filter Primary Soft PU end cap Element With Sleeve



VOLVO 11033996  
VOLVO BM 110339967  
CATERPILLAR 142-1340

Secondary Filter uses A-8580  
Set Filter uses AS-8579-S

H 1 : 521 (mm)  
H 2 : 510 (mm)  
OD 1 : 313 (mm)  
OD 2 : 313 (mm)  
ID 1 : 178 (mm)

CONT : 1  
VOL : 0.057



# Sakura Filter

# Technical Specification

**AS-8579-S** Air Filter Set Soft PU end cap Element With Sleeve

TEREX 15270188 + 15270189  
HITACHI 76612497+4466268  
SANY  
B22210000641+B22210000640

Primary Filter uses AS-8579  
Secondary Filter uses A-8580

H 1 : 521 (mm)  
H 2 : 510 (mm)  
OD 1 : 313 (mm)  
OD 2 : 313 (mm)  
ID 1 : 178 (mm)

CONT : 1  
VOL : 0.057

31

**C-1511** Oil Filter Full Flow Spin-On

ISUZU 8-94217272-0  
ISUZU 8-94360426-0  
ISUZU 8-94430983-0  
SANY A22210000569



H 1 : 100 (mm)  
OD 1 : 90 (mm)  
Thread Size : M20X1.5-6H  
BPV (kg/cm2) : 1.0  
ADBV : YES  
Gasket Type : Round

CONT : 25  
VOL : 0.029

36

**C-56191** Oil Filter Full Flow Spin-On long life

KOMATSU 600-211-2110  
CASE 87409203  
NEW HOLLAND (CNH) 87415600  
CUMMINS C6002112110



H 1 : 86.5 (mm)  
OD 1 : 76 (mm)  
Thread Size : 3/4-16 UNF-2B  
BPV (kg/cm2) : 1.0  
ADBV : YES  
Gasket Type : Square

CONT : 36  
VOL : 0.032

Note : C-56190(bottom plate difference)

41

**AS-8579M** Air Filter Primary Soft PU+Metal Element With Sleeve

HITACHI 76612497



Secondary Filter uses A-8580  
Set Filter uses AS-8579M-S

H 1 : 521 (mm)  
H 2 : 510 (mm)  
OD 1 : 313 (mm)  
OD 2 : 313 (mm)  
ID 1 : 178 (mm)

CONT : 1  
VOL : 0.060

Note : with metal reinforcement

32

**C-1538** Oil Filter Full Flow Spin-On

HOLDEN 8-9421-7272-2



H 1 : 95 (mm)  
OD 1 : 93 (mm)  
Thread Size : M20X1.5-6H  
BPV (kg/cm2) : 1.0  
ADBV : YES  
Gasket Type : Square

CONT : 25  
VOL : 0.037

Note : C-1503,C-1511 (bottom plate difference)

37

**C-6701** Oil Filter Full Flow Spin-On

GENERAL MOTORS 25010792  
OPEL 650381  
ISUZU 8-25010792-0



H 1 : 85.5 (mm)  
OD 1 : 76 (mm)  
Thread Size : M18X1.5-6H  
Gasket Type : Square

CONT : 50  
VOL : 0.034

42

**AS-9231** Air Filter Primary Metal End Cap Element With Sleeve

FORD 221406  
CATERPILLAR 3I-0823



Secondary Filter uses A-5016  
Set Filter uses AS-9231-S

H 1 : 362 (mm)  
H 2 : 355.5 (mm)  
OD 1 : 131.5 (mm)  
OD 2 : 104 (mm)  
ID 1 : 63 (mm)  
ID 2 : 17 (mm)

CONT : 9  
VOL : 0.070

33

**C-5102** Oil Filter Full Flow Spin-On

PERKINS 26540347  
PERKINS 2654407  
LIUGONG 53C0324



H 1 : 168 (mm)  
OD 1 : 93 (mm)  
Thread Size : 3/4-16 UNF-2B  
BPV (kg/cm2) : 1.0  
ADBV : YES  
Gasket Type : Square

CONT : 25  
VOL : 0.050

38

**C-7942** Oil Filter Full Flow Spin-On

DAEWOO 65.05510-5017  
DAEWOO 65.05510-5020



H 1 : 246.5 (mm)  
OD 1 : 116 (mm)  
Thread Size : 1 1/2-12 UNF-2B  
ADBV : YES  
Gasket Type : Square

CONT : 6  
VOL : 0.029

43

**AS-9231-S** Air Filter Set Metal End Cap Element With Sleeve

FORD 221406+272744



Primary Filter uses AS-9231  
Secondary Filter uses A-5016

H 1 : 362 (mm)  
H 2 : 355.5 (mm)  
OD 1 : 131.5 (mm)  
OD 2 : 104 (mm)  
ID 1 : 63 (mm)  
ID 2 : 17 (mm)

CONT : 9  
VOL : 0.079

34

**C-5504** Oil Filter Full Flow Spin-On

CATERPILLAR 1R-0734  
CATERPILLAR 9L-9054  
CATERPILLAR 9L-9200



H 1 : 145 (mm)  
OD 1 : 93 (mm)  
Thread Size : 1-12 UNF-2B  
BPV (kg/cm2) : 1.0  
ADBV : YES  
Gasket Type : Square

CONT : 25  
VOL : 0.041

39

**C-8901** Oil Filter Full Flow Spin-On

DAEWOO 65.05510.5022  
DAEWOO 65.05510.5022B  
DAEWOO 650.5510.5016



H 1 : 203 (mm)  
OD 1 : 118 (mm)  
Thread Size : 1 1/2-12 UNF-2B  
ADBV : YES  
Gasket Type : Round

CONT : 6  
VOL : 0.022

44

**C-1011** Oil Filter Full Flow Spin-On

JAC 1017100GG010  
NISSAN 15208-HC400  
HINO 15607-1920  
MAZDA JEYO-14-302  
MAZDA JEYO-14-302



H 1 : 85 (mm)  
OD 1 : 68 (mm)  
Thread Size : M20X1.5-6H  
BPV (kg/cm2) : 1.0  
ADBV : YES  
Gasket Type : Round

CONT : 50  
VOL : 0.026

Note : Gasket Square version uses C-1030

35

**C-5611** Oil Filter Full Flow Spin-On Synthetic Media

CUMMINS 3977910  
KOMATSU 6736-51-5142



H 1 : 174.4 (mm)  
OD 1 : 93 (mm)  
Thread Size : 1-16 UNF-2B  
ADBV : YES  
Gasket Type : Square

CONT : 12  
VOL : 0.027

Note : C-5610 cellulose media,C-5611 syntetic media

40

**CA-89100** Cabin Air Filter Plastic framed Element

DOOSAN 471-00119



H 1 : 34.5 (mm)  
Length 1 : 301 (mm)  
Width 1 : 147 (mm)

CONT : 20  
VOL : 0.068

Note : Daewoo Excavator model:DH225-9/DH220-9/DH215-9

45

**F-2601** Fuel Filter Metal End Cap Element

MERCEDES-BENZ 1457431261  
IVECO 190605  
DAEWOO 65.12503-5003



H 1 : 113 (mm)  
H 2 : 107 (mm)  
OD 1 : 64 (mm)  
OD 2 : 64 (mm)  
ID 1 : 13 (mm)  
ID 2 : 13 (mm)

CONT : 50  
VOL : 0.035

Note : Paper Protector

**F-5210** Fuel Filter Metal End Cap Element

YANMAR 129100-55650  
KUBOTA 15521-43160  
KUBOTA 607



H 1 : 89 (mm)  
OD 1 : 50 (mm)  
OD 2 : 50 (mm)  
ID 1 : 20 (mm)

CONT : 50  
VOL : 0.017

**H-2704** Hydraulic Oil Filter Metal End Cap Element

DAEWOO 2474-9003B  
DAEWOO 2474-9008  
HITACHI 4227353



H 1 : 456 (mm)  
H 2 : 438 (mm)  
OD 1 : 112 (mm)  
OD 2 : 112 (mm)  
ID 1 : 66 (mm)  
ID 2 : 66 (mm)

CONT : 10  
VOL : 0.079

**F-2603** Fuel Filter Metal End Cap Element

MERCEDES-BENZ 000 477 31 15  
DAIMLER BENZ 4220900051  
STEYR-DAIMLER-PUCH 614080740



H 1 : 145 (mm)  
H 2 : 130 (mm)  
OD 1 : 84.5 (mm)  
OD 2 : 84.5 (mm)  
ID 1 : 13 (mm)  
ID 2 : 13 (mm)

CONT : 50  
VOL : 0.062

**FC-1007** Fuel Filter Spin-On

CATERPILLAR 103-2901  
TOYOTA 233203391071



H 1 : 100 (mm)  
H 2 : 100 (mm)  
OD 1 : 80 (mm)  
Thread Size : M20X1.5-6H  
Gasket Type : Round

CONT : 50  
VOL : 0.041

**H-2709** Hydraulic Oil Filter Metal End Cap Element

KOMATSU 07063-01383  
KOMATSU 208-60-61150  
HITACHI 4287634  
HITACHI 76580323



H 1 : 450 (mm)  
OD 1 : 180 (mm)  
OD 2 : 180 (mm)  
ID 1 : 110 (mm)  
ID 2 : 110 (mm)

CONT : 9  
VOL : 0.173

**F-2604** Fuel Filter Metal End Cap Element

MERCEDES-BENZ 000 477 40 15  
MERCEDES-BENZ 000 477 45 15  
MERCEDES-BENZ 355 470 01 92



H 1 : 145 (mm)  
H 2 : 138 (mm)  
OD 1 : 83 (mm)  
OD 2 : 83 (mm)  
ID 1 : 14 (mm)  
ID 2 : 14 (mm)

CONT : 50  
VOL : 0.062

**FC-1801** Fuel Filter Spin-On

NISSAN 16403-09W00  
NISSAN 16403-27000



H 1 : 80 (mm)  
OD 1 : 80 (mm)  
Thread Size : 3/4-16 UNF-2B  
Gasket Type : Round

CONT : 50  
VOL : 0.037

**H-2719** Hydraulic Oil Filter Metal End Cap Element Cellulose media

HYUNDAI 31E3-0018  
HITACHI 4294135  
YAMASHIN DT-04-10-10



H 1 : 87 (mm)  
H 2 : 83.5 (mm)  
OD 1 : 42.5 (mm)  
OD 2 : 42.5 (mm)  
ID 1 : 21.5 (mm)

CONT : 50  
VOL : 0.011

Note : Wiremesh type uses H-5211

**F-2621** Fuel Filter Metal End Cap Element

MERCEDES-BENZ 352 470 00 92



H 1 : 114.6 (mm)  
H 2 : 101 (mm)  
OD 1 : 64 (mm)  
OD 2 : 64 (mm)  
ID 1 : 13 (mm)  
ID 2 : 13 (mm)

CONT : 50  
VOL : 0.032

**FC-5103** Fuel Filter Can-type Housing

ALLIS CHALMERS 1919100  
MANITOU 49660  
CASE K915319



H 1 : 71 (mm)  
OD 1 : 85 (mm)  
OD 2 : 89 (mm)  
ID 1 : 39 (mm)  
ID 2 : 15 (mm)

CONT : 50  
VOL : 0.036

**H-7911** Hydraulic Oil Filter Metal End Cap Element

KOMATSU 07063-01210  
KOMATSU 205-60-51430



H 1 : 450 (mm)  
OD 1 : 150 (mm)  
OD 2 : 150 (mm)  
ID 1 : 110 (mm)  
ID 2 : 110 (mm)

CONT : 6  
VOL : 0.080

Note : Without gasket

**F-2622** Fuel Filter Metal End Cap Element

MERCEDES-BENZ 4773815  
DAEWOO 65125035001  
CASE 714401R92  
CLAAS 99104



H 1 : 112 (mm)  
H 2 : 102 (mm)  
OD 1 : 69 (mm)  
OD 2 : 69 (mm)  
ID 1 : 19 (mm)  
ID 2 : 19 (mm)

CONT : 50  
VOL : 0.053

**FC-52030** Fuel Filter Primary Spin-On

YANMAR 123907-55801



H 1 : 159 (mm)  
OD 1 : 90 (mm)  
Thread Size : M20X1.5-6H  
Gasket Type : Round

CONT : 25  
VOL : 0.052

**H-7923** Hydraulic Oil Filter Element With Microfiber media

KOBELCO YN52V01011P1  
KOBELCO YN52V01016R100



H 1 : 249 (mm)  
H 2 : 231 (mm)  
OD 1 : 144 (mm)  
OD 2 : 142.5 (mm)  
ID 1 : 96.5 (mm)  
ID 2 : 96.5 (mm)  
Thread Size : 4 7/16-11 G

CONT : 12  
VOL : 0.082



# Sakura Filter

# Technical Specification

**H-89030** Hydraulic Oil Filter Metal End Cap Element

DAEWOO 2474-9016A  
DOOSAN 2474-9016A



H 1 : 146 (mm)  
H 2 : 140 (mm)  
OD 1 : 150 (mm)  
OD 2 : 150 (mm)  
ID 1 : 73.4 (mm)  
Thread Size : M12X1.75-6H

CONT : 9  
VOL : 0.045

61

**SFC-5509-10** Fuel/Water Separator Spin-On With Drain and Sensor Port 10 Micron

CUMMINS 3406889  
CUMMINS 3954891  
CUMMINS 3954904  
CUMMINS 4070801  
SANY B222100000462



H 1 : 211 (mm)  
OD 1 : 93 (mm)  
Thread Size : 1-14 UNS-2B  
Gasket Type : Square

CONT : 12  
VOL : 0.036

66

**SFC-7939-30B** Fuel/Water Separator Spin-On With Bowl 30 Micron

DAF 143 3649  
MAN 511.2503.0052  
SANY 60033346



H 1 : 319 (mm)  
OD 1 : 108 (mm)  
Thread Size : 1-14 UNS-2B  
Gasket Type : Square

CONT : 6  
VOL : 0.030

Note : SFC-7939-30 and FB-7939

71

**H-89050** Hydraulic Oil Filter Pilot Metal End Cap Element

DAEWOO 474-00009



H 1 : 136.5 (mm)  
H 2 : 133 (mm)  
OD 1 : 42.5 (mm)  
OD 2 : 42.5 (mm)  
ID 1 : 21.5 (mm)

CONT : 50  
VOL : 0.018

62

**SFC-5701-10** Fuel/Water Separator Spin-On 10 Micron

CASE 335341A1  
CUMMINS 3413084  
DAEWOO 65125035016



H 1 : 174 (mm)  
OD 1 : 93 (mm)  
Thread Size : 1-14 UNS-2B  
Gasket Type : Square

CONT : 12  
VOL : 0.031

67

**WC-5705** Coolant Filter Spin-On

CUMMINS 299080  
CUMMINS 3100304  
CUMMINS 3305367



H 1 : 100 (mm)  
OD 1 : 93 (mm)  
Thread Size : 11/16-16 UNF-2B  
Gasket Type : Square

CONT : 12  
VOL : 0.018

Note : Coolants 4 units

72

**HC-5503** Hydraulic Oil Filter Spin-On Synthetic Media

CATERPILLAR 1081153  
INGERSOLL RAND 51302214  
VOLVO BM 9658998



H 1 : 293 (mm)  
OD 1 : 122 (mm)  
Thread Size : 1 3/4-12 UNF-2B

CONT : 6  
VOL : 0.032

Note : with Glass Fiber media

63

**SFC-5705** Fuel/Water Separator Spin-On

ISUZU 1-13240044-1  
CUMMINS 3308638  
CUMMINS 3315843  
SUNWARD 750201011130



H 1 : 174 (mm)  
OD 1 : 93 (mm)  
Thread Size : 1-14 UNS-2B  
Thread Size : M14X2.0  
Gasket Type : Square

CONT : 12  
VOL : 0.026

68

**WC-5713** Coolant Filter Spin-On

HITACHI 4228689  
INGERSOLL RAND 57165805



H 1 : 136 (mm)  
OD 1 : 93 (mm)  
Thread Size : 11/16-16 UNF-2B  
Gasket Type : Square

CONT : 12  
VOL : 0.022

Note : Coolants 15 units

73

**HC-6802** Hydraulic Oil Filter Spin-On

LOESING 025105  
MASSEY-FERGUSON 2979653M1  
VOLVO 4787923  
INGERSOLL RAND 54672654



H 1 : 200 (mm)  
OD 1 : 93 (mm)  
Thread Size : 1-12 UNF-2B  
BPV (kg/cm2) : YES  
Gasket Type : Square

CONT : 12  
VOL : 0.034

64

**SFC-5709-10** Fuel/Water Separator Spin-On 10 Micron

CATERPILLAR 256-8753  
CUMMINS 3329289  
HITACHI 4377880  
SANY B222100000596



H 1 : 245 (mm)  
OD 1 : 93 (mm)  
Thread Size : 1-14 UNS-2B  
Gasket Type : Square

CONT : 6  
VOL : 0.019

69

**HC-76130** Hydraulic Oil Filter Transmission Spin-On With Microfiber media

ZF 0501323154  
J.C.BAMFORD 32925905  
CASE 8603535  
CASE 87519452  
JOHN DEERE AT336140



H 1 : 199 (mm)  
OD 1 : 94.5 (mm)  
Thread Size : 1 3/8-12 UNF-2B  
Thread Stud Size : M24X1.5

CONT : 12  
VOL : 0.024

65

**SFC-7939-30** Fuel/Water Separator Spin-On 30 Micron

DAF 143 3649  
MAN 51.12503.0052  
FAW 612600081294  
DOOSAN K1006529



H 1 : 229 (mm)  
OD 1 : 108 (mm)  
Thread Size : 1-14 UNS-2B  
Gasket Type : Square

CONT : 6  
VOL : 0.024

Note : bowl not included

70

**DOOSAN 2**



# Engine Application

A

# Sakura Filter

# ENGINE APPLICATION

MODEL/APPLICATION	SAKURA NO	MODEL/APPLICATION	SAKURA NO	MODEL/APPLICATION	SAKURA NO
<b>DOOSAN</b>		<b>DOOSAN</b>		<b>DOOSAN</b>	
D20S-7 ( <i>FORKLIFTS</i> ) DOOSAN D24NAP TIER4 , 2400, 2017 Oil Filter..... C-88360		Hydraulic Oil Filter..... H-89030		DX27Z ( <i>EXCAVATORS</i> ) YANMAR , 2007-UP Fuel Filter..... FC-1302 Oil Filter Full Flow..... C-1720	
D25S-7 ( <i>FORKLIFTS</i> ) DOOSAN D24NAP TIER4 , 2400, 2017 Oil Filter..... C-88360		DL420A ( <i>LOADERS</i> ) DOOSAN DE12TIS Cabin Air Filter..... CA-52010		DX210 ( <i>EXCAVATORS</i> )  Hydraulic Oil Filter Pilot..... H-89070 Hydraulic Oil Filter..... H-89060	
D30S-7 ( <i>FORKLIFTS</i> ) DOOSAN D24NAP TIER4 , 2400, 2017 Oil Filter..... C-88360		DL500 ( <i>LOADERS</i> ) CUMMINS QSM11 Hydraulic Oil Filter..... H-89030		DX225NLC ( <i>EXCAVATORS</i> ) DOOSAN DL06 Hydraulic Oil Filter..... H-89030 Oil Filter Full Flow..... C-88260	
D33S-7 ( <i>FORKLIFTS</i> ) DOOSAN D24NAP TIER4 , 2400, 2017 Oil Filter..... C-88360		DX140W ( <i>EXCAVATORS</i> ) DOOSAN DL06 Hydraulic Oil Filter..... H-89030 Oil Filter Full Flow..... C-88260		DX225LCA ( <i>EXCAVATORS</i> ) DB58TIS Air Filter Breather..... A-52210 Fuel/Water Separator..... SFC-89020	
DA40-5 ( <i>DUMP TRUCKS</i> ) DOOSAN Cabin Air Filter..... CA-88390		DX180LC ( <i>EXCAVATORS</i> ) DOOSAN DL06 Hydraulic Oil Filter..... H-89030 Oil Filter Full Flow..... C-88260		DX210W-5 ( <i>EXCAVATORS</i> ) DL06P Fuel/Water Separator..... SFC-89020	
DD80 ( <i>TRACTORS</i> ) DOOSAN DB85 Hydraulic Oil Filter..... HC-55240		DX140 ( <i>EXCAVATORS</i> )  Hydraulic Oil Filter..... H-89060 Hydraulic Oil Filter Pilot..... H-89070		DX200A ( <i>EXCAVATORS</i> ) DB58TIS Fuel/Water Separator..... SF-88040	
DH320 ( <i>EXCAVATORS</i> ) DOOSAN D2366T Hydraulic Oil Filter..... H-89030		DX140LC-5 ( <i>EXCAVATORS</i> ) PERKINS 1204F , 4400 Hydraulic Oil Filter..... H-52230		DX350 ( <i>EXCAVATORS</i> )  Hydraulic Oil Filter Pilot..... H-89070 Hydraulic Oil Filter..... H-89060	
DL250 ( <i>LOADERS</i> ) DOOSAN DL06 Hydraulic Oil Filter..... H-89030 Oil Filter Full Flow..... C-88260		DX140LC ( <i>EXCAVATORS</i> ) DOOSAN DL06 Hydraulic Oil Filter..... H-89030 Oil Filter Full Flow..... C-88260		DX360 ( <i>EXCAVATORS</i> )  Hydraulic Oil Filter Pilot..... H-89070 Hydraulic Oil Filter..... H-89060	
DL200 ( <i>LOADERS</i> ) DOOSAN DL06 Hydraulic Oil Filter..... H-89030 Oil Filter Full Flow..... C-88260		DX190W ( <i>EXCAVATORS</i> ) DOOSAN DL06 Hydraulic Oil Filter..... H-89030 Oil Filter Full Flow..... C-88260		DX300LC ( <i>EXCAVATORS</i> ) DOOSAN DL08 Hydraulic Oil Filter..... H-52250	
DL250TC ( <i>LOADERS</i> ) DOOSAN DL06 Hydraulic Oil Filter..... H-89030 Oil Filter Full Flow..... C-88260		DX210W ( <i>EXCAVATORS</i> ) DOOSAN DL06 , 2007-UP Air Filter Primary..... A-5666 Air Filter Secondary..... A-5667 Fuel Filter..... FC-5725 Fuel/Water Separator..... SFC-7903-30 Hydraulic Oil Filter..... H-2719		DX340LC ( <i>EXCAVATORS</i> ) DOOSAN DL08 , 2006-UP Air Filter Primary..... AS-8579 Air Filter Set..... AS-8579-S Air Filter Primary..... AS-8579M Air Filter Secondary..... A-8580 Fuel/Water Separator..... SFC-7939-30 Fuel/Water Separator..... SFC-7939-30B Hydraulic Oil Filter..... H-2719	
DL300 ( <i>EXCAVATORS</i> ) DOOSAN DL08 , 2005-UP Fuel/Water Separator..... SFC-7939-30 Fuel/Water Separator..... SFC-7939-30B		DX255LC ( <i>EXCAVATORS</i> ) DOOSAN DL06 , 2007-UP Air Filter Primary..... A-5666 Air Filter Secondary..... A-5667 Fuel Filter..... FC-5725 Fuel/Water Separator..... SFC-7903-30 Hydraulic Oil Filter..... H-2719		DX35Z ( <i>EXCAVATORS</i> ) YANMAR 3TNV88-SDB , 2006-UP Air Filter Primary..... A-8513 Air Filter Secondary..... A-5669 Fuel Filter..... FC-1302 Oil Filter Full Flow..... C-1720	
DL300 ( <i>LOADERS</i> ) DOOSAN DL08 Hydraulic Oil Filter..... H-89030		DX255LCV ( <i>EXCAVATORS</i> ) 2006-UP Air Filter Secondary..... A-5667 Air Filter Primary..... A-5666 Fuel Filter..... FC-5725 Fuel/Water Separator..... SFC-7903-30 Hydraulic Oil Filter..... H-2719		DX300-3 ( <i>EXCAVATORS</i> )  Hydraulic Oil Filter..... H-89060 Hydraulic Oil Filter Pilot..... H-89070	
DL350-3 ( <i>LOADERS</i> ) SCANIA DC09 Hydraulic Oil Filter..... H-52250				DX340LC-V ( <i>EXCAVATORS</i> ) 2005-UP Fuel/Water Separator..... SFC-7939-30	
DL400 ( <i>EXCAVATORS</i> ) CUMMINS QSL9 , 2005-UP Coolant Filter..... WC-5712 Fuel Filter..... FC-5521 Fuel/Water Separator..... SFC-7939-30 Fuel/Water Separator..... SFC-7939-30B					
DL400 ( <i>LOADERS</i> ) CUMMINS QSL9 Hydraulic Oil Filter..... H-89030					
DL450 ( <i>LOADERS</i> ) CUMMINS QSM11					



MODEL/APPLICATION	SAKURA NO	MODEL/APPLICATION	SAKURA NO
<b>DOOSAN</b>		<b>DOOSAN</b>	
<b>DX340LC-V</b> (EXCAVATORS) 2005-UP Fuel/Water Separator.....	SFC-7939-30B	<b>SOLAR 300LCV</b> (EXCAVATORS) DE08TIS Hydraulic Oil Filter.....	H-27321
<b>DX300LC-3</b> (EXCAVATORS) DOOSAN DL08K Hydraulic Oil Filter breaker.....	H-52260	<b>SOLAR 75V</b> (EXCAVATORS) YANMAR 4TNE98 Hydraulic Oil Filter.....	H-2704
<b>DX300LC-5</b> (EXCAVATORS) SCANIA DC09 Hydraulic Oil Filter breaker.....	H-52260	<b>SOLAR 330LCV</b> (EXCAVATORS) DE12T Hydraulic Oil Filter.....	H-27321
<b>DX420LC</b> (EXCAVATORS) DOOSAN DV11 , 2006-UP Air Filter Set..... Air Filter Primary..... Air Filter Primary..... Air Filter Secondary..... Fuel/Water Separator..... Fuel/Water Separator..... Hydraulic Oil Filter.....	AS-8579-S AS-8579M AS-8579 A-8580 SFC-7939-30B SFC-7939-30 H-2719		
<b>DX420LC-V</b> (EXCAVATORS) 2005-UP Fuel/Water Separator..... Fuel/Water Separator.....	SFC-7939-30B SFC-7939-30		
<b>DX480LC-V</b> (EXCAVATORS) 2005-UP Fuel/Water Separator..... Fuel/Water Separator.....	SFC-7939-30B SFC-7939-30		
<b>DX520LC-V</b> (EXCAVATORS) 2005-UP Fuel/Water Separator..... Fuel/Water Separator.....	SFC-7939-30B SFC-7939-30		
<b>DX700</b> (EXCAVATORS) ISUZU AH-6WG1X Fuel/Water Separator.....	SFC-89010		
<b>MEGA 500</b> (LOADERS) CUMMINS QSM11 , 2007-UP Coolant Filter..... Fuel/Water Separator.....	WC-5703 SFC-5709-10		
<b>S225NLC-V</b> (EXCAVATORS) DB58TIS Air Filter Breather.....	A-52210		
<b>S225NLC-V</b> (EXCAVATORS) DOOSAN DB58TIS Cabin Air Filter.....	CA-52010		
<b>SOLAR 160WV</b> (EXCAVATORS) DAEWOO DB58TIS , 2006-UP Air Filter Primary..... Air Filter Secondary..... Air Filter Set..... Fuel/Water Separator..... Hydraulic Oil Filter..... Hydraulic Oil Filter..... Hydraulic Oil Filter.....	A-5639 A-5635 A-5654-S SFC-5701-10 H-7911 H-2719 H-2704		
<b>SOLAR 175LCV</b> (EXCAVATORS) DAEWOO DB58TIS Fuel/Water Separator..... Hydraulic Oil Filter.....	SFC-5701-10 H-7911		

# Technical Specification

**B**



# Sakura Filter

# Technical Specification

**A-52210** Air Filter Breather Metal End Cap Element

DOOSAN K1029257



H 1 : 51 (mm)  
H 2 : 45 (mm)  
OD 1 : 67 (mm)  
OD 2 : 67 (mm)  
ID 1 : 43.5 (mm)  
ID 2 : 21 (mm)

CONT : 50  
VOL : 0.017

**A-5666** Air Filter Primary Soft PU end cap Element

LOESING 020622  
KOMATSU 1308462H1  
KOMATSU 600-185-4110  
JOHN DEERE AT178516



Secondary Filter uses A-5667  
Set Filter uses A-5668-S

H 1 : 483 (mm)  
H 2 : 470 (mm)  
OD 1 : 237 (mm)  
OD 2 : 237 (mm)  
ID 1 : 132 (mm)

CONT : 1  
VOL : 0.031

**AS-8579-S** Air Filter Set Soft PU end cap Element With Sleeve

TEREX 15270188 + 15270189  
HITACHI 76612497+4466268  
SANY  
B22210000641+B22210000640



Primary Filter uses AS-8579  
Secondary Filter uses A-8580

H 1 : 521 (mm)  
H 2 : 510 (mm)  
OD 1 : 313 (mm)  
OD 2 : 313 (mm)  
ID 1 : 178 (mm)

CONT : 1  
VOL : 0.057

**A-5569** Air Filter Secondary Soft PU end cap Element

VOLVO 11801160  
CATERPILLAR 1467473  
LIUGONG 40C0445  
JOHN DEERE M131803  
KOMATSU YM12905112530



Primary Filter uses A-8513  
Set Filter uses A-5570-S

H 1 : 265 (mm)  
H 2 : 259 (mm)  
OD 1 : 61 (mm)  
OD 2 : 59 (mm)  
ID 1 : 45 (mm)

CONT : 25  
VOL : 0.048

**A-5667** Air Filter Secondary Soft PU end cap Element

LOESING 022062  
KOMATSU 1308463H1  
CASE 249988A1  
KOMATSU 600-185-4120



Primary Filter uses A-5666  
Set Filter uses A-5668-S

H 1 : 469 (mm)  
H 2 : 463 (mm)  
OD 1 : 134 (mm)  
OD 2 : 125 (mm)  
ID 1 : 95.5 (mm)

CONT : 9  
VOL : 0.097

**AS-8579M** Air Filter Primary Soft PU+Metal Element With Sleeve

HITACHI 76612497



Secondary Filter uses A-8580  
Set Filter uses AS-8579M-S

H 1 : 521 (mm)  
H 2 : 510 (mm)  
OD 1 : 313 (mm)  
OD 2 : 313 (mm)  
ID 1 : 178 (mm)

CONT : 1  
VOL : 0.060

Note : with metal reinforcement

**A-5635** Air Filter Secondary Metal End Cap Element

DAEWOO 2474-9054  
KOMATSU 600-181-6730  
MITSUBISHI ME033839



Primary Filter uses A-8513  
Set Filter uses A-5654-S

H 1 : 415 (mm)  
H 2 : 402 (mm)  
OD 1 : 133.5 (mm)  
OD 2 : 133.5 (mm)  
ID 1 : 105 (mm)  
ID 2 : 17 (mm)

CONT : 9  
VOL : 0.086

**A-8513** Air Filter Primary Soft PU end cap Element

YANMAR 119808-12520  
NISSAN 16546-FJ100  
KOMATSU 3EB-02-38730  
SUNWARD 730403000157



Secondary Filter uses A-5569  
Set Filter uses A-5570-S

H 1 : 273.5 (mm)  
H 2 : 265 (mm)  
OD 1 : 104 (mm)  
OD 2 : 104 (mm)  
ID 1 : 61 (mm)

CONT : 25  
VOL : 0.110

Note : A-85134(with Flame Retardant Media)

**C-1720** Oil Filter Full Flow Spin-On

TCM 12163-82302  
YANMAR 129150-35152



H 1 : 100 (mm)  
OD 1 : 90 (mm)  
Thread Size : M20X1.5-6H  
BPV (kg/cm<sup>2</sup>) : 1.0  
ADB V : YES  
Gasket Type : Round

CONT : 36  
VOL : 0.040

**A-5639** Air Filter Primary Metal End Cap Element

KOBELCO 2451-U324-3  
MITSUBISHI 3433000400



Secondary Filter uses A-5635  
Set Filter uses A-5654-S

H 1 : 455 (mm)  
H 2 : 442 (mm)  
OD 1 : 263.5 (mm)  
OD 2 : 221 (mm)  
ID 1 : 136 (mm)  
ID 2 : 23 (mm)

CONT : 1  
VOL : 0.036

**A-8580** Air Filter Secondary Soft PU end cap Element

CATERPILLAR 142-1403  
ATLAS COPCO 3222-1881-92  
LIUGONG 40C0321  
HITACHI 4466268



Primary Filter uses A-8579  
Set Filter uses A-8579-S

H 1 : 500 (mm)  
H 2 : 494 (mm)  
OD 1 : 179 (mm)  
OD 2 : 174 (mm)  
ID 1 : 148 (mm)

CONT : 1  
VOL : 0.019

Note : Is a Secondary Air filter of A-8579M,A-8665M

**C-5707** Oil Filter Combination Spin-On Seamless

J.C.BAMFORD 02/910965  
CUMMINS 3401544  
FOTON 3401544F  
KOMATSU 6742-01-4540



H 1 : 294 (mm)  
OD 1 : 118 (mm)  
Thread Size : 2 1/4-12 UNF-2B  
Gasket Type : Square

CONT : 6  
VOL : 0.029

Note : Multilayer

**A-5654-S** Air Filter Set Metal End Cap Element

KOMATSU 600-181-6740



Primary Filter uses A-5639  
Secondary Filter uses A-5635

H 1 : 455 (mm)  
H 2 : 442 (mm)  
OD 1 : 263.5 (mm)  
OD 2 : 221 (mm)  
ID 1 : 135 (mm)  
ID 2 : 23 (mm)

CONT : 1  
VOL : 0.036

**AS-8579** Air Filter Primary Soft PU end cap Element With Sleeve

VOLVO 11033996  
VOLVO BM 110339967  
CATERPILLAR 142-1340



Secondary Filter uses A-8580  
Set Filter uses AS-8579-S

H 1 : 521 (mm)  
H 2 : 510 (mm)  
OD 1 : 313 (mm)  
OD 2 : 313 (mm)  
ID 1 : 178 (mm)

CONT : 1  
VOL : 0.057

**C-88260** Oil Filter Full Flow Spin-On

DOOSAN 400508-00036



H 1 : 200 (mm)  
OD 1 : 108 (mm)  
Thread Size : 1 1/2-16 UNF-2B  
Gasket Type : Square

CONT : 12  
VOL : 0.038

**C-88360** Oil Filter Spin-On  
BOBCAT 7343102



H 1 : 108 (mm)  
OD 1 : 93 (mm)  
Thread Size : 1-12 UNF-2B  
BPV (kg/cm2) : 1.0  
Gasket Type : Square

CONT : 25  
VOL : 0.034

16

**FC-5725** Fuel Filter Spin-On Synthetic Media  
DAF 1399760  
IVECO 2992241  
CUMMINS 4897833



H 1 : 191 (mm)  
OD 1 : 93 (mm)  
Thread Size : M20X1.5-6H  
Gasket Type : Square

CONT : 12  
VOL : 0.030

21

**H-52250** Hydraulic Oil Filter Metal End Cap Element  
DOOSAN 400504-00035



H 1 : 420 (mm)  
H 2 : 416 (mm)  
OD 1 : 178 (mm)  
OD 2 : 178 (mm)  
ID 1 : 109 (mm)  
ID 2 : 109 (mm)

CONT : 1  
VOL : 0.018

26

**CA-52010** Cabin Air Filter Plastic framed Element  
DOOSAN 400402-00001

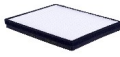

H 1 : 20 (mm)  
Length 1 : 211 (mm)  
Length 2 : 201 (mm)  
Width 1 : 182.5 (mm)  
Width 2 : 164 (mm)

CONT : 20  
VOL : 0.022

17

**H-2704** Hydraulic Oil Filter Metal End Cap Element  
DAEWOO 2474-9003B  
DAEWOO 2474-9008  
HITACHI 4227353



H 1 : 456 (mm)  
H 2 : 438 (mm)  
OD 1 : 112 (mm)  
OD 2 : 112 (mm)  
ID 1 : 66 (mm)  
ID 2 : 66 (mm)

CONT : 10  
VOL : 0.079

22

**H-52260** Hydraulic Oil Filter breaker Metal End Cap Element  
DOOSAN 474-00041



H 1 : 308.5 (mm)  
H 2 : 304.5 (mm)  
OD 1 : 60 (mm)  
OD 2 : 60 (mm)  
ID 1 : 33 (mm)  
ID 2 : 33 (mm)

CONT : 25  
VOL : 0.042

Note : Doosan Crawler Excavator DX300 LC

27

**CA-88390** Cabin Air Filter Paper framed Element



H 1 : 35 (mm)  
Length 1 : 224 (mm)  
Width 1 : 222 (mm)

CONT : 0  
VOL : 0.000

18

**H-2719** Hydraulic Oil Filter Metal End Cap Element Cellulose media  
HYUNDAI 31E3-0018  
HITACHI 4294135  
YAMASHIN DT-04-10-10



H 1 : 87 (mm)  
H 2 : 83.5 (mm)  
OD 1 : 42.5 (mm)  
OD 2 : 42.5 (mm)  
ID 1 : 21.5 (mm)

CONT : 50  
VOL : 0.011

Note : Wiremesh type uses H-5211

23

**H-7911** Hydraulic Oil Filter Metal End Cap Element  
KOMATSU 07063-01210  
KOMATSU 205-60-51430



H 1 : 450 (mm)  
OD 1 : 150 (mm)  
OD 2 : 150 (mm)  
ID 1 : 110 (mm)  
ID 2 : 110 (mm)

CONT : 6  
VOL : 0.080

Note : Without gasket

28

**FC-1302** Fuel Filter Spin-On  
TCM 20801-02112



H 1 : 75 (mm)  
OD 1 : 80 (mm)  
Thread Size : M20X1.5-6H  
Gasket Type : Round

CONT : 50  
VOL : 0.034

19

**H-27321** Hydraulic Oil Filter Wire Mesh supported Element  
DOOSAN 24719401A



H 1 : 196.5 (mm)  
H 2 : 190 (mm)  
OD 1 : 200 (mm)  
OD 2 : 200 (mm)  
ID 1 : 113 (mm)  
Thread Size : M10X1.5-6H

CONT : 4  
VOL : 0.044

Note : H-27320(Media wire mesh difference)

24

**H-89030** Hydraulic Oil Filter Metal End Cap Element  
DAEWOO 2474-9016A  
DOOSAN 2474-9016A



H 1 : 146 (mm)  
H 2 : 140 (mm)  
OD 1 : 150 (mm)  
OD 2 : 150 (mm)  
ID 1 : 73.4 (mm)  
Thread Size : M12X1.75-6H

CONT : 9  
VOL : 0.045

29

**FC-5521** Fuel Filter Spin-On  
SANY 21027915  
CUMMINS 3973232  
NEW HOLLAND (CNH) 87360572



H 1 : 174 (mm)  
OD 1 : 93 (mm)  
Thread Size : 7/8-14 UNF-2B  
Gasket Type : Square

CONT : 12  
VOL : 0.027

20

**H-52230** Hydraulic Oil Filter Metal End Cap Element With Microfiber media  
DOOSAN 400504-00225



H 1 : 419 (mm)  
H 2 : 414 (mm)  
OD 1 : 150 (mm)  
OD 2 : 150 (mm)  
ID 1 : 110 (mm)  
ID 2 : 110 (mm)

CONT : 1  
VOL : 0.012

25

**H-89060** Hydraulic Oil Filter Aluminium casting end cap, Element  
DOOSAN 400504-00240



H 1 : 134 (mm)  
H 2 : 127 (mm)  
OD 1 : 44 (mm)  
OD 2 : 42.5 (mm)  
ID 1 : 22.5 (mm)

CONT : 50  
VOL : 0.019

30

**H-89070** Hydraulic Oil Filter Pilot Aluminium casting end cap, Element  
DOOSAN 400504-00241



H 1 : 85 (mm)  
H 2 : 77.5 (mm)  
OD 1 : 44 (mm)  
OD 2 : 42.5 (mm)  
ID 1 : 22.5 (mm)

CONT : 50  
VOL : 0.014

31

**SFC-7903-30** Fuel/Water Separator Spin-On 30 Micron  
DOOSAN K1006530



H 1 : 149 (mm)  
OD 1 : 108 (mm)  
Thread Size : 1-14 UNS-2B  
Gasket Type : Square

CONT : 6  
VOL : 0.017

Note : bowl not included

36

**WC-5703** Coolant Filter Spin-On  
CUMMINS 3318319  
HITACHI 4266063  
KOMATSU 6742-01-3490



H 1 : 136 (mm)  
OD 1 : 93 (mm)  
Thread Size : 11/16-16 UNF-2B  
Gasket Type : Square

CONT : 12  
VOL : 0.018

Note : Coolants 23 units

41

**HC-55240** Hydraulic Oil Filter Aluminium casting seat, Spin-On Synthetic Media  
LOESING 20107  
CATERPILLAR 310568  
INGERSOLL RAND 90536046  
FORD 9576P163555



H 1 : 240 (mm)  
OD 1 : 94.5 (mm)  
Thread Size : 1 3/8-12 UNF-2B

CONT : 12  
VOL : 0.036

32

**SFC-7939-30** Fuel/Water Separator Spin-On 30 Micron  
DAF 143 3649  
MAN 51.12503.0052  
FAW 612600081294  
DOOSAN K1006529



H 1 : 229 (mm)  
OD 1 : 108 (mm)  
Thread Size : 1-14 UNS-2B  
Gasket Type : Square

CONT : 6  
VOL : 0.024

Note : bowl not included

37

**WC-5712** Coolant Filter Spin-On  
CUMMINS 3100307  
CUMMINS 3315114  
CUMMINS 3316053



H 1 : 135 (mm)  
OD 1 : 93 (mm)  
Thread Size : 11/16-16 UNF-2B  
Gasket Type : Square

CONT : 12  
VOL : 0.020

Note : Coolants 12 units

42

**SF-88040** Fuel/Water Separator Plastic End Cap Element  
DOOSAN 400508-00128



H 1 : 138 (mm)  
H 2 : 122 (mm)  
OD 1 : 88 (mm)  
OD 2 : 72 (mm)  
ID 1 : 34 (mm)

CONT : 50  
VOL : 0.080

Note : For Excavator Doosan DX200A

33

**SFC-7939-30B** Fuel/Water Separator Spin-On With Bowl 30 Micron  
DAF 143 3649  
MAN 511.2503.0052  
SANY 60033346



H 1 : 319 (mm)  
OD 1 : 108 (mm)  
Thread Size : 1-14 UNS-2B  
Gasket Type : Square

CONT : 6  
VOL : 0.030

Note : SFC-7939-30 and FB-7939

38

**SFC-5701-10** Fuel/Water Separator Spin-On 10 Micron  
CASE 335341A1  
CUMMINS 3413084  
DAEWOO 65125035016



H 1 : 174 (mm)  
OD 1 : 93 (mm)  
Thread Size : 1-14 UNS-2B  
Gasket Type : Square

CONT : 12  
VOL : 0.031

34

**SFC-89010** Fuel/Water Separator Spin-On Without Bowl  
DOOSAN 400508-00063



H 1 : 195 (mm)  
OD 1 : 108 (mm)  
Thread Size : M24X1.5-6H  
Gasket Type : Square

CONT : 12  
VOL : 0.039

39

**SFC-5709-10** Fuel/Water Separator Spin-On 10 Micron  
CATERPILLAR 256-8753  
CUMMINS 3329289  
HITACHI 4377880  
SANY B222100000596



H 1 : 245 (mm)  
OD 1 : 93 (mm)  
Thread Size : 1-14 UNS-2B  
Gasket Type : Square

CONT : 6  
VOL : 0.019

35

**SFC-89020** Fuel/Water Separator Spin-On  
DAEWOO 400508-00062  
DOOSAN 400508-00062



H 1 : 140 (mm)  
OD 1 : 108 (mm)  
Thread Size : M24X1.5-6H

CONT : 12  
VOL : 0.035

40



**HYUNDAI 3**

# Engine Application

A

MODEL/APPLICATION	SAKURA NO	MODEL/APPLICATION	SAKURA NO	MODEL/APPLICATION	SAKURA NO
<b>HYUNDAI</b>		<b>HYUNDAI</b>		<b>HYUNDAI</b>	
<b>160</b> (EXCAVATORS) CUMMINS QSB 5.9		<b>H-80</b> (DOZERS) CUMMINS		Air Filter Set.....	A-8652-S
Air Filter Set.....	AS-2833-S	Oil Filter Full Flow.....	C-5703	<b>HL770</b> (LOADERS) CUMMINS LTA10	
Air Filter Secondary.....	A-2832	<b>HDF20-5</b> (FORKLIFTS) YANMAR 4TNE98 , 2005-UP		Air Filter Primary.....	A-28710
Air Filter Primary.....	AS-2831	Fuel Filter.....	FC-1016	Air Filter Set.....	A-28730-S
<b>180</b> (EXCAVATORS) CUMMINS QSB 5.9		Oil Filter Full Flow.....	C-8012	Air Filter Primary.....	A-28770
Air Filter Primary.....	AS-2831	<b>HDF30 II</b> (FORKLIFTS) ISUZU		Air Filter Set.....	A-28770-S
Air Filter Secondary.....	A-2832	Oil Filter Full Flow.....	C-1538	Air Filter Secondary.....	A-28780
Air Filter Set.....	AS-2833-S	Oil Filter Full Flow.....	C-1511	Air Filter Secondary.....	A-7967
<b>210LC-7</b> (EXCAVATORS) CUMMINS , 2002-UP		<b>HDF35</b> (FORKLIFTS) PERKINS 1004.4		Cabin Air Filter.....	CA-28240
Oil Filter Full Flow.....	C-5714	Oil Filter Full Flow.....	C-5102	Coolant Filter.....	WC-5713
<b>290LC-7</b> (EXCAVATORS) CUMMINS , 2002-UP		<b>HL17</b> (LOADERS) CUMMINS 6BT5.9		Fuel/Water Separator.....	SFC-5705
Fuel Filter Secondary.....	FC-7903	Fuel Filter Secondary.....	FC-7903	Fuel/Water Separator Secondary..	SFC-1905-10
Fuel/Water Separator.....	SFC-5706	Fuel/Water Separator.....	SFC-5706	Hydraulic Oil Filter.....	H-2719
<b>290LC-7</b> (EXCAVATORS) CUMMINS CUMMINS , 2002		Hydraulic Oil Filter.....	H-2719	Hydraulic Oil Filter.....	HC-6802
Fuel Filter Secondary.....	FC-7903	Oil Filter Full Flow.....	C-5704	Oil Filter Combination.....	C-5723
<b>330LC-9A</b> (EXCAVATORS) CUMMINS QSL9		<b>HL25</b> (LOADERS) CUMMINS 6CT8.3		<b>HL770-7A</b> (LOADERS) CUMMINS QSL9-C220 , 2007-UP	
Cabin Air Filter.....	CA-28181	Coolant Filter.....	WC-5711	Air Filter Primary.....	A-28770
<b>33HDLL</b> (EXCAVATORS)		Fuel Filter Secondary.....	FC-7903	Coolant Filter.....	WC-5712
Air Filter Secondary.....	A-6009	Fuel/Water Separator.....	SFC-5706	Fuel/Water Separator.....	SFC-5711
Air Filter Set.....	AS-1024-S	Hydraulic Oil Filter Transmission...	HC-2701	Hydraulic Oil Filter.....	H-2719
Air Filter Primary.....	AS-1024	Hydraulic Oil Filter.....	H-2719	<b>HL770-7A</b> (LOADERS) CUMMINS QSL9-C280 , 2007-UP	
Fuel Filter Secondary.....	FC-7903	Oil Filter Full Flow.....	O-1010	Air Filter Primary.....	A-28770
Fuel/Water Separator.....	SFC-5706	Oil Filter Combination.....	C-5723	Air Filter Secondary.....	A-28780
Hydraulic Oil Filter.....	H-2725	<b>HL35</b> (LOADERS) CUMMINS LTA10-C290 , 2007-UP		Air Filter Primary.....	A-28770
Hydraulic Oil Filter.....	HC-7940	Coolant Filter.....	WC-5713	Air Filter Set.....	A-28770-S
Hydraulic Oil Filter.....	H-2719	Fuel/Water Separator.....	SFC-5705	<b>HL770-7A</b> (LOADERS) CUMMINS QSL9-C280 , 2007	
<b>42HDLL</b> (EXCAVATORS)		Oil Filter Combination.....	C-5723	Air Filter Set.....	A-28770-S
Air Filter Set.....	AS-1024-S	<b>HL35</b> (LOADERS) CUMMINS LTA10		Air Filter Primary.....	A-28770
Air Filter Primary.....	AS-1024	Air Filter Set.....	A-28730-S	Air Filter Secondary.....	A-28780
Air Filter Secondary.....	A-6009	Air Filter Secondary.....	A-7967	<b>HL720-3</b> (LOADERS) DEUTZ BF4M1012	
Coolant Filter.....	WC-5711	Air Filter Primary.....	A-28710	Air Filter Secondary.....	A-6705
Fuel Filter Secondary.....	FC-7903	Coolant Filter.....	WC-5712	Hydraulic Oil Filter.....	H-2719
Fuel/Water Separator.....	SFC-5706	Coolant Filter.....	WC-5713	Oil Filter Full Flow.....	C-6202
Hydraulic Oil Filter.....	HC-7940	Fuel/Water Separator Secondary...	SFC-1905-10	<b>HL730-3</b> (LOADERS) CUMMINS	
Hydraulic Oil Filter.....	H-2719	Fuel/Water Separator.....	SFC-5705	Air Filter Primary.....	AS-1024
Oil Filter Combination.....	C-5723	Hydraulic Oil Filter.....	H-2719	Air Filter Set.....	AS-1024-S
<b>770</b> (LOADERS) CUMMINS		Oil Filter Combination.....	C-5723	Air Filter Secondary.....	A-6009
Air Filter Primary.....	A-28770	<b>HL757-9</b> (LOADERS) CUMMINS QSB6.7 , 2012		Air Filter Secondary.....	A-6705
<b>770</b> (LOADERS) CUMMINS CUMMINS		Air Filter Primary.....	A-8650	Fuel Filter Secondary.....	FC-7903
Air Filter Secondary.....	A-28780	Air Filter Set.....	A-8652-S	Fuel/Water Separator.....	SFC-5706
Air Filter Primary.....	A-28770	<b>HL757TM-9</b> (LOADERS) CUMMINS QSB6.7 , 2012		Hydraulic Oil Filter.....	H-2719
Air Filter Set.....	A-28770-S	Air Filter Primary.....	A-8650	Hydraulic Oil Filter Transmission...	HC-2701
<b>H-70</b> (DOZERS) CUMMINS		Air Filter Set.....	A-8652-S	Oil Filter Full Flow.....	C-5703
Fuel/Water Separator.....	SFC-5708	<b>HL757XTD-9</b> (LOADERS) CUMMINS QSB6.7 , 2012		Oil Filter Full Flow.....	C-6202
Oil Filter Full Flow.....	C-5703	Air Filter Primary.....	A-8650	<b>HL730-3</b> (LOADERS) DEUTZ BF4M1012	
				Air Filter Secondary.....	A-6009



MODEL/APPLICATION	SAKURA NO	MODEL/APPLICATION	SAKURA NO	MODEL/APPLICATION	SAKURA NO
<b>HYUNDAI</b>		<b>HYUNDAI</b>		<b>HYUNDAI</b>	
<b>HL730-3</b> (LOADERS) DEUTZ BF4M1012		Hydraulic Oil Filter.....	H-2719	Air Filter Primary.....	A-28710
Air Filter Primary.....	AS-1024	Oil Filter Full Flow.....	C-5704	Air Filter Set.....	A-28730-S
Air Filter Set.....	AS-1024-S	Oil Filter Full Flow.....	C-5703	Air Filter Breather.....	A-71330
Air Filter Secondary.....	A-6705			Air Filter Secondary.....	A-7967
Fuel Filter Secondary.....	FC-7903	<b>HL750</b> (LOADERS) CUMMINS 6BT5.9		Fuel Filter.....	FC-45010
Fuel/Water Separator.....	SFC-5706	Fuel Filter Secondary.....	FC-7903	Fuel/Water Separator.....	SFC-5711
Hydraulic Oil Filter.....	H-2719	Fuel/Water Separator.....	SFC-5706	Oil Filter Full Flow.....	C-5708
Hydraulic Oil Filter Transmission...	HC-2701	Hydraulic Oil Filter.....	H-2719		
Oil Filter Full Flow.....	C-6202	Oil Filter Full Flow.....	C-5704	<b>HL770-7</b> (LOADERS) CUMMINS QSC8.3-C299 , 2007-UP	
Oil Filter Full Flow.....	C-5703			Fuel/Water Separator.....	SFC-5702-10
		<b>HL750TM</b> (LOADERS)			
<b>HL730-7</b> (LOADERS) CUMMINS B3.9C , 2004-UP		Fuel Filter Secondary.....	FC-7903	<b>HL770-7</b> (LOADERS) 2006-UP	
Air Filter Breather.....	A-71330	Fuel/Water Separator.....	SFC-5706	Air Filter Secondary.....	A-2832
Air Filter Primary.....	AS-2831	Hydraulic Oil Filter.....	H-2719	Air Filter Set.....	AS-2833-S
Air Filter Secondary.....	A-2832	Oil Filter Combination.....	C-5723	Air Filter Primary.....	AS-2831
Air Filter Set.....	AS-2833-S			Fuel/Water Separator.....	SFC-5702-10
Hydraulic Oil Filter.....	H-2719	<b>HL757-7</b> (LOADERS) CUMMINS QSB5.9-C173 , 2004-UP		Hydraulic Oil Filter.....	H-2719
		Air Filter Secondary.....	A-2832		
<b>HL730-7</b> (LOADERS)		Air Filter Breather.....	A-71330	<b>HL770XTD-7A</b> (LOADERS) CUMMINS QSL9-C280 , 2007-UP	
Cabin Air Filter.....	CA-28230	Air Filter Primary.....	AS-2831	Coolant Filter.....	WC-5712
		Air Filter Set.....	AS-2833-S		
<b>HL740-3</b> (LOADERS) CUMMINS		Fuel/Water Separator.....	SFC-55200	<b>HL780</b> (LOADERS) CUMMINS N14-C335 , 2007-UP	
Air Filter Set.....	AS-1024-S	Hydraulic Oil Filter.....	H-2719	Coolant Filter.....	WC-5703
Air Filter Primary.....	AS-1024			Fuel/Water Separator.....	SFC-5705
Air Filter Secondary.....	A-6009	<b>HL757-7</b> (LOADERS) 1998			
Fuel Filter Secondary.....	FC-7903	Cabin Air Filter.....	CA-28230	<b>HL780</b> (LOADERS) CUMMINS N14-C360 , 2007-UP	
Fuel/Water Separator.....	SFC-5706			Coolant Filter.....	WC-5703
Hydraulic Oil Filter.....	H-2719	<b>HL757-7A</b> (LOADERS) CUMMINS QSB6.7 , 2007-UP		Fuel Filter.....	FC-5702
Hydraulic Oil Filter Transmission...	HC-2701	Air Filter Breather.....	A-71330	Oil Filter Combination.....	C-5723
Oil Filter Full Flow.....	C-5703	Fuel Filter.....	FC-45010		
Oil Filter Full Flow.....	C-5704	Fuel/Water Separator.....	SFC-5711	<b>HL780-3</b> (LOADERS) CUMMINS N14 SERIES , 2004-UP	
		Oil Filter Full Flow.....	C-5708	Air Filter Set.....	A-6903-S
<b>HL740-7</b> (LOADERS) CUMMINS QSB5.9-C , 2004-UP		<b>HL760</b> (LOADERS) CUMMINS 6CT8.3		Air Filter Primary.....	A-6903
Air Filter Breather.....	A-71330	Air Filter Set.....	A-28730-S	Air Filter Secondary.....	A-6902
Air Filter Primary.....	AS-2831	Air Filter Secondary.....	A-7967	Coolant Filter.....	WC-5713
Air Filter Secondary.....	A-2832	Air Filter Primary.....	A-28710	Fuel/Water Separator Secondary..	SFC-1905-10
Air Filter Set.....	AS-2833-S	Coolant Filter.....	WC-5711	Fuel/Water Separator.....	SFC-5705
Fuel/Water Separator.....	SFC-55200	Fuel Filter Secondary.....	FC-7903	Hydraulic Oil Filter.....	HC-5503
Hydraulic Oil Filter.....	H-2719	Fuel/Water Separator.....	SFC-5706	Hydraulic Oil Filter.....	H-2719
		Hydraulic Oil Filter Transmission...	HC-2701	Oil Filter Combination.....	C-5723
<b>HL740-7A</b> (LOADERS) CUMMINS QSB6.7 , 2007-UP		Hydraulic Oil Filter.....	H-2719		
Air Filter Breather.....	A-71330	Hydraulic Oil Filter Transmission..	HC-76130	<b>HL780-3A</b> (LOADERS) 2004-UP	
Fuel Filter.....	FC-45010	Oil Filter Combination.....	C-5723	Air Filter Primary.....	A-6903
Hydraulic Oil Filter.....	H-2719			Air Filter Secondary.....	A-6902
Oil Filter Full Flow.....	C-5708	<b>HL760-7</b> (LOADERS) CUMMINS QSB5.9-C220 , 2007-UP		Air Filter Set.....	A-6903-S
		Oil Filter Full Flow.....	C-5708	Fuel/Water Separator.....	SFC-5709-10
<b>HL740-7A</b> (LOADERS) CUMMINS QSB6.7 , 2007		<b>HL760-7</b> (LOADERS) 2006-UP		Hydraulic Oil Filter Transmission..	HC-76130
Air Filter Secondary.....	A-28720	Air Filter Set.....	AS-2833-S	Hydraulic Oil Filter.....	H-2719
		Air Filter Secondary.....	A-2832		
<b>HL740TM-3</b> (LOADERS) CUMMINS		Air Filter Breather.....	A-71330	<b>HL780-7A</b> (LOADERS) CUMMINS QSM11 , 2006-UP	
Air Filter Secondary.....	A-6009	Air Filter Primary.....	AS-2831	Air Filter Secondary.....	A-6902
Air Filter Set.....	AS-1024-S	Hydraulic Oil Filter.....	H-2719	Air Filter Set.....	A-6903-S
Air Filter Primary.....	AS-1024	Oil Filter Full Flow.....	C-5708	Air Filter Primary.....	A-6903
Fuel Filter Secondary.....	FC-7903			Fuel/Water Separator.....	SFC-5709-10
Fuel/Water Separator.....	SFC-5706	<b>HL760-7A</b> (LOADERS) CUMMINS QSB6.7 , 2007-UP			
Hydraulic Oil Filter Transmission...	HC-2701			<b>HL730</b> (LOADERS) CUMMINS QSB 5.9	
				Air Filter Set.....	AS-2833-S

MODEL/APPLICATION	SAKURA NO	MODEL/APPLICATION	SAKURA NO	MODEL/APPLICATION	SAKURA NO
<b>HYUNDAI</b>		<b>HYUNDAI</b>		<b>HYUNDAI</b>	
<b>HL730</b> (LOADERS) CUMMINS QSB 5.9		Hydraulic Oil Filter.....	HC-7940	Fuel/Water Separator.....	SFC-5706
Air Filter Secondary.....	A-2832	Oil Filter Full Flow.....	C-5703	Hydraulic Oil Filter.....	HC-7940
Air Filter Primary.....	AS-2831	<b>R130LC</b> (EXCAVATORS) CUMMINS 4BTA3.9		Hydraulic Oil Filter.....	H-2719
<b>HL730-7A</b> (LOADERS) CUMMINS QSB4.5 , 2007-UP		Air Filter Secondary.....	A-5437	Hydraulic Oil Filter.....	H-2725
Air Filter Secondary.....	A-2832	Air Filter Breather.....	A-71330	<b>R140LC-7A</b> (EXCAVATORS) MITSUBISHI D04FD-TAA , 2008-UP	
Air Filter Primary.....	AS-2831	Air Filter Primary.....	AS-8502	Air Filter Breather.....	A-71330
Air Filter Set.....	AS-2833-S	Air Filter Set.....	AS-8502-S	<b>R140LC-7A</b> (EXCAVATORS) MITSUBISHI D04FD-TAA , 2008	
Air Filter Breather.....	A-71330	Fuel Filter Secondary.....	FC-7903	Cabin Air Filter.....	CA-28240
Oil Filter Full Flow.....	C-5708	Fuel/Water Separator.....	SFC-5706	<b>R140LC-7A</b> (EXCAVATORS) D04FD-TAA	
<b>HL770-3</b> (LOADERS)		Hydraulic Oil Filter.....	HC-7940	Oil Filter Full Flow.....	C-56141
Air Filter Primary.....	A-28770	Hydraulic Oil Filter.....	H-2719	<b>R140W-7A</b> (EXCAVATORS) MITSUBISHI D04FD-TAA , 2008-UP	
<b>HSL650-7</b> (LOADERS)		Oil Filter Full Flow.....	C-5703	Air Filter Breather.....	A-71330
Air Filter Secondary.....	A-8599	<b>R130W-3</b> (EXCAVATORS) 2006-UP		<b>R140W-7A</b> (EXCAVATORS) MITSUBISHI D04FD-TAA , 2008	
Air Filter Primary.....	A-8505	Air Filter Breather.....	A-71330	Hydraulic Oil Filter.....	HC-28130
Fuel Filter.....	FC-1804	Air Filter Set.....	AS-1024-S	<b>R140W-7A</b> (EXCAVATORS) MITSUBISHI D04FD-TAA , 2012	
Oil Filter Full Flow.....	C-7926	Air Filter Secondary.....	A-6009	Oil Filter Full Flow.....	C-56141
<b>HSL810</b> (LOADERS)		Air Filter Primary.....	AS-1024	<b>R140W-9</b> (EXCAVATORS) D04FD-TAA	
Fuel Filter.....	FC-1016	Fuel Filter Secondary.....	FC-7903	Oil Filter Full Flow.....	C-56141
Oil Filter Full Flow.....	C-8012	Fuel/Water Separator.....	SFC-5706	<b>R145CR -9</b> (EXCAVATORS) D04FD-TAA	
<b>HSL850-7</b> (LOADERS)		Hydraulic Oil Filter.....	HC-7940	Oil Filter Full Flow.....	C-56141
Fuel Filter.....	FC-1804	Hydraulic Oil Filter.....	H-2719	<b>R140LC-9</b> (EXCAVATORS) MITSUBISHI D04FD-TAA , 2012	
Oil Filter Full Flow.....	C-7921	Oil Filter Full Flow.....	C-5703	Cabin Air Filter.....	CA-28181
<b>HSL610</b> (LOADERS) YANMAR 4TNE88		<b>R140LC-7</b> (EXCAVATORS) 2006-UP		<b>R140LC-9</b> (EXCAVATORS) D04FD-TAA	
Oil Filter Full Flow.....	C-8012	Air Filter Breather.....	A-71330	Oil Filter Full Flow.....	C-56141
<b>LC250</b> (LOADERS)		Air Filter Set.....	AS-2833-S	<b>R140W-9</b> (EXCAVATORS) CUMMINS QSB6.7 , 2012	
Hydraulic Oil Filter.....	H-2725	Air Filter Secondary.....	A-2832	Cabin Air Filter.....	CA-28181
<b>R110-7</b> (EXCAVATORS) 2006-UP		Air Filter Primary.....	AS-2831	<b>R160LC-3</b> (EXCAVATORS) CUMMINS , 2006-UP	
Air Filter Breather.....	A-71330	Fuel Filter Secondary.....	FC-7903	Air Filter Secondary.....	A-6009
Air Filter Primary.....	AS-8502	Fuel/Water Separator.....	SFC-5706	Air Filter Breather.....	A-71330
Air Filter Secondary.....	A-5437	Hydraulic Oil Filter.....	H-2719	Air Filter Primary.....	AS-1024
Air Filter Set.....	AS-8502-S	Hydraulic Oil Filter.....	H-2725	Air Filter Set.....	AS-1024-S
Fuel Filter.....	FC-1010	Hydraulic Oil Filter.....	HC-7940	Fuel Filter Secondary.....	FC-7903
Hydraulic Oil Filter.....	H-2719	Oil Filter Full Flow.....	C-5703	Fuel/Water Separator.....	SFC-5706
Hydraulic Oil Filter.....	H-2725	<b>R140W-7</b> (EXCAVATORS) CUMMINS 4BTA3.9-C100 , 2007-UP		Hydraulic Oil Filter.....	HC-7940
Hydraulic Oil Filter.....	HC-7940	Fuel/Water Separator.....	SFC-5706	Hydraulic Oil Filter.....	H-2719
Oil Filter Full Flow.....	C-5614	Oil Filter Full Flow.....	C-5703	Oil Filter Full Flow.....	C-5703
<b>R110 -7A</b> (EXCAVATORS) D04FD-TAA		<b>R140LC-7</b> (EXCAVATORS) S/N: TIER II-UP , 2006-UP		<b>R140W-9</b> (EXCAVATORS) CUMMINS QSB6.7 , 2012	
Oil Filter Full Flow.....	C-56141	Air Filter Set.....	AS-2833-S	Cabin Air Filter.....	CA-28181
<b>R120W</b> (EXCAVATORS) CUMMINS 4BTA3.9		Air Filter Secondary.....	A-2832	<b>R160LC-3</b> (EXCAVATORS) CUMMINS , 2006-UP	
Air Filter Secondary.....	A-5437	Air Filter Primary.....	AS-2831	Air Filter Secondary.....	A-6009
Air Filter Primary.....	AS-8502	Fuel Filter Secondary.....	FC-7903	Air Filter Breather.....	A-71330
Air Filter Set.....	AS-8502-S	Fuel/Water Separator.....	SFC-5706	Air Filter Primary.....	AS-1024
Fuel Filter Secondary.....	FC-7903	Hydraulic Oil Filter.....	H-2719	Air Filter Set.....	AS-1024-S
Fuel/Water Separator.....	SFC-5706	Hydraulic Oil Filter.....	H-2725	Fuel Filter Secondary.....	FC-7903
Hydraulic Oil Filter.....	H-2719	Oil Filter Full Flow.....	C-5703	Fuel/Water Separator.....	SFC-5706
<b>R130W-7</b> (EXCAVATORS) 2006-UP		<b>R140W-7</b> (EXCAVATORS) CUMMINS 4BTA3.9-C115 , 2007-UP		Hydraulic Oil Filter.....	HC-7940
Air Filter Secondary.....	A-5437	Fuel/Water Separator.....	SFC-5706	Hydraulic Oil Filter.....	H-2719
Air Filter Primary.....	AS-8502	Oil Filter Full Flow.....	C-5703	Hydraulic Oil Filter.....	HC-7940
Air Filter Set.....	AS-8502-S	<b>R140W-9</b> (EXCAVATORS) 2006-UP		Oil Filter Full Flow.....	C-5703
Fuel Filter Secondary.....	FC-7903	Air Filter Secondary.....	A-2832	<b>R160LC-7</b> (EXCAVATORS) 2006-UP	
Fuel/Water Separator.....	SFC-5706	Air Filter Breather.....	A-71330	Air Filter Set.....	AS-2833-S
Hydraulic Oil Filter.....	H-2719	Air Filter Set.....	AS-2833-S	Air Filter Secondary.....	A-2832
<b>R140W-7A</b> (EXCAVATORS) 2006-UP		Air Filter Primary.....	AS-2831	Air Filter Breather.....	A-71330
Air Filter Secondary.....	A-5437	Fuel Filter Secondary.....	FC-7903	Air Filter Primary.....	AS-2831
Air Filter Primary.....	AS-8502	Hydraulic Oil Filter.....	H-2719	Fuel Filter.....	FC-1010
Air Filter Set.....	AS-8502-S	Hydraulic Oil Filter.....	H-2725	Hydraulic Oil Filter.....	H-2719
Fuel Filter Secondary.....	FC-7903	Hydraulic Oil Filter.....	HC-7940	Hydraulic Oil Filter.....	H-2725
Fuel/Water Separator.....	SFC-5706	Oil Filter Full Flow.....	C-5703	Hydraulic Oil Filter.....	HC-7940
Hydraulic Oil Filter.....	H-2719	<b>R140W-9</b> (EXCAVATORS) 2006-UP		Oil Filter Full Flow.....	C-2702
<b>R140W-7A</b> (EXCAVATORS) 2006-UP		Air Filter Secondary.....	A-2832	<b>R160LC-7</b> (EXCAVATORS) 2006-UP	
Air Filter Breather.....	A-71330	Air Filter Breather.....	A-71330	Air Filter Set.....	AS-2833-S
Air Filter Primary.....	AS-2831	Air Filter Set.....	AS-2833-S	Air Filter Secondary.....	A-2832
Fuel Filter.....	FC-1010	Air Filter Primary.....	AS-2831	Air Filter Breather.....	A-71330
Hydraulic Oil Filter.....	H-2719	Fuel Filter Secondary.....	FC-7903	Air Filter Primary.....	AS-2831
Hydraulic Oil Filter.....	H-2725	Hydraulic Oil Filter.....	H-2719	Fuel Filter.....	FC-1010
Hydraulic Oil Filter.....	HC-7940	Hydraulic Oil Filter.....	H-2725	Hydraulic Oil Filter.....	H-2719
Oil Filter Full Flow.....	C-2702	Hydraulic Oil Filter.....	HC-7940	Hydraulic Oil Filter.....	HC-7940
<b>R140W-9</b> (EXCAVATORS) 2006-UP		Oil Filter Full Flow.....	C-5703	Oil Filter Full Flow.....	C-2702
Air Filter Secondary.....	A-6009	<b>R140W-9</b> (EXCAVATORS) 2006-UP		<b>R160LC-7</b> (EXCAVATORS) 2006-UP	
Air Filter Breather.....	A-71330	Air Filter Secondary.....	A-2832	Air Filter Set.....	AS-2833-S
Air Filter Primary.....	AS-1024	Air Filter Breather.....	A-71330	Air Filter Secondary.....	A-2832
Air Filter Set.....	AS-1024-S	Air Filter Set.....	AS-2833-S	Air Filter Breather.....	A-71330
Fuel Filter Secondary.....	FC-7903	Air Filter Primary.....	AS-2831	Air Filter Primary.....	AS-2831
Fuel/Water Separator.....	SFC-5706	Fuel Filter.....	FC-1010	Fuel Filter.....	FC-1010
Hydraulic Oil Filter.....	HC-7940	Hydraulic Oil Filter.....	H-2719	Hydraulic Oil Filter.....	H-2719
Hydraulic Oil Filter.....	H-2719	Hydraulic Oil Filter.....	H-2725	Hydraulic Oil Filter.....	H-2725
Oil Filter Full Flow.....	C-5703	Hydraulic Oil Filter.....	HC-7940	Hydraulic Oil Filter.....	HC-7940
<b>R140W-9</b> (EXCAVATORS) 2006-UP		Oil Filter Full Flow.....	C-5703	Oil Filter Full Flow.....	C-2702
Air Filter Secondary.....	A-6009	<b>R140W-9</b> (EXCAVATORS) 2006-UP		<b>R160LC-7</b> (EXCAVATORS) 2006-UP	
Air Filter Breather.....	A-71330	Air Filter Secondary.....	A-2832	Air Filter Set.....	AS-2833-S
Air Filter Primary.....	AS-1024	Air Filter Breather.....	A-71330	Air Filter Secondary.....	A-2832
Air Filter Set.....	AS-1024-S	Air Filter Set.....	AS-2833-S	Air Filter Breather.....	A-71330
Fuel Filter Secondary.....	FC-7903	Air Filter Primary.....	AS-2831	Air Filter Primary.....	AS-2831
Fuel/Water Separator.....	SFC-5706	Fuel Filter.....	FC-1010	Fuel Filter.....	FC-1010
Hydraulic Oil Filter.....	HC-7940	Hydraulic Oil Filter.....	H-2719	Hydraulic Oil Filter.....	H-2719
Hydraulic Oil Filter.....	H-2719	Hydraulic Oil Filter.....	H-2725	Hydraulic Oil Filter.....	H-2725
Oil Filter Full Flow.....	C-5703	Hydraulic Oil Filter.....	HC-7940	Hydraulic Oil Filter.....	HC-7940
<b>R140W-9</b> (EXCAVATORS) 2006-UP		Oil Filter Full Flow.....	C-5703	Oil Filter Full Flow.....	C-2702
Air Filter Secondary.....	A-6009	<b>R140W-9</b> (EXCAVATORS) 2006-UP		<b>R160LC-7</b> (EXCAVATORS) 2006-UP	
Air Filter Breather.....	A-71330	Air Filter Secondary.....	A-2832	Air Filter Set.....	AS-2833-S
Air Filter Primary.....	AS-1024	Air Filter Breather.....	A-71330	Air Filter Secondary.....	A-2832
Air Filter Set.....	AS-1024-S	Air Filter Set.....	AS-2833-S	Air Filter Breather.....	A-71330
Fuel Filter Secondary.....	FC-7903	Air Filter Primary.....	AS-2831	Air Filter Primary.....	AS-2831
Fuel/Water Separator.....	SFC-5706	Fuel Filter.....	FC-1010	Fuel Filter.....	FC-1010
Hydraulic Oil Filter.....	HC-7940	Hydraulic Oil Filter.....	H-2719	Hydraulic Oil Filter.....	H-2719
Hydraulic Oil Filter.....	H-2719	Hydraulic Oil Filter.....	H-2725	Hydraulic Oil Filter.....	H-2725
Oil Filter Full Flow.....	C-5703	Hydraulic Oil Filter.....	HC-7940	Hydraulic Oil Filter.....	HC-7940
<b>R140W-9</b> (EXCAVATORS) 2006-UP		Oil Filter Full Flow.....	C-5703	Oil Filter Full Flow.....	C-2702
Air Filter Secondary.....	A-6009	<b>R140W-9</b> (EXCAVATORS) 2006-UP		<b>R160LC-7</b> (EXCAVATORS) 2006-UP	
Air Filter Breather.....	A-71330	Air Filter Secondary.....	A-2832	Air Filter Set.....	AS-2833-S
Air Filter Primary.....	AS-1024	Air Filter Breather.....	A-71330	Air Filter Secondary.....	A-2832
Air Filter Set.....	AS-1024-S	Air Filter Set.....	AS-2833-S	Air Filter Breather.....	A-71330
Fuel Filter Secondary.....	FC-7903	Air Filter Primary.....	AS-2831	Air Filter Primary.....	AS-2831
Fuel/Water Separator.....	SFC-5706	Fuel Filter.....	FC-1010	Fuel Filter.....	FC-1010
Hydraulic Oil Filter.....	HC-7940	Hydraulic Oil Filter.....	H-2719	Hydraulic Oil Filter.....	H-2719
Hydraulic Oil Filter.....	H-2719	Hydraulic Oil Filter.....	H-2725	Hydraulic Oil Filter.....	H-2725
Oil Filter Full Flow.....	C-5703	Hydraulic Oil Filter.....	HC-7940	Hydraulic Oil Filter.....	HC-7940

# Sakura Filter

# ENGINE APPLICATION

MODEL/APPLICATION	SAKURA NO	MODEL/APPLICATION	SAKURA NO	MODEL/APPLICATION	SAKURA NO
<b>HYUNDAI</b>		<b>HYUNDAI</b>		<b>HYUNDAI</b>	
<b>R160LC-7A</b> (EXCAVATORS) MITSUBISHI D04FD-TAA , 2008-UP		Air Filter Breather.....	A-71330	<b>R200W-7</b> (EXCAVATORS) 2006-UP	
Air Filter Breather.....	A-71330	Air Filter Secondary.....	A-6009	Air Filter Breather.....	A-71330
<b>R160LC-7A</b> (EXCAVATORS) D04FD-TAA		Air Filter Primary.....	AS-1024	Air Filter Set.....	AS-2833-S
Oil Filter Full Flow.....	C-56141	Air Filter Set.....	AS-1024-S	Air Filter Primary.....	AS-2831
<b>R160LC -9</b> (EXCAVATORS) D04FD-TAA		Fuel Filter Secondary.....	FC-7903	Air Filter Secondary.....	A-2832
Oil Filter Full Flow.....	C-56141	Fuel Filter.....	FC-1010	Fuel Filter Secondary.....	FC-7903
<b>R160LC-9</b> (EXCAVATORS) MITSUBISHI D04FD-TAA , 2012		Fuel/Water Separator.....	SFC-5706	Hydraulic Oil Filter.....	HC-7940
Cabin Air Filter.....	CA-28181	Hydraulic Oil Filter.....	H-2719	Hydraulic Oil Filter.....	H-2719
<b>R170W-3</b> (EXCAVATORS) CUMMINS 6BTA5.9		Hydraulic Oil Filter.....	H-2725	Hydraulic Oil Filter.....	H-2725
Air Filter Secondary.....	A-6009	Hydraulic Oil Filter.....	HC-7940	Oil Filter Full Flow.....	C-5704
Air Filter Set.....	AS-1024-S	<b>R180LC-7</b> (EXCAVATORS) 2006-UP		Air Filter Breather.....	A-71330
Air Filter Breather.....	A-71330	Air Filter Set.....	AS-2833-S	Fuel Filter.....	FC-1010
Air Filter Primary.....	AS-1024	Air Filter Breather.....	A-71330	Hydraulic Oil Filter.....	H-2719
Fuel Filter Secondary.....	FC-7903	Air Filter Secondary.....	A-2832	Hydraulic Oil Filter.....	H-2725
Fuel/Water Separator.....	SFC-5706	Air Filter Primary.....	AS-2831	Hydraulic Oil Filter.....	HC-7940
Hydraulic Oil Filter.....	H-2725	Fuel Filter.....	FC-1010	Oil Filter Full Flow.....	C-2702
Hydraulic Oil Filter.....	H-2719	Hydraulic Oil Filter.....	H-2719	<b>R180LC-7A</b> (EXCAVATORS) MITSUBISHI D04FD-TAA , 2008-UP	
Hydraulic Oil Filter.....	HC-7940	Hydraulic Oil Filter.....	H-2725	Air Filter Breather.....	A-71330
Oil Filter Full Flow.....	C-5704	Hydraulic Oil Filter.....	HC-7940	<b>R180LC-7A</b> (EXCAVATORS) MITSUBISHI D04FD-TAA , 2008	
<b>R170W-7</b> (EXCAVATORS) 2006-UP		Oil Filter Full Flow.....	C-2702	Cabin Air Filter.....	CA-28240
Air Filter Primary.....	AS-2831	<b>R180LC-7A</b> (EXCAVATORS) D04FD-TAA		Oil Filter Full Flow.....	C-56141
Air Filter Secondary.....	A-2832	<b>R180LC-9</b> (EXCAVATORS) MITSUBISHI D04FD-TAA , 2012		Cabin Air Filter.....	CA-28181
Air Filter Breather.....	A-71330	<b>R180LC-9</b> (EXCAVATORS) D04FD-TAA		Oil Filter Full Flow.....	C-56141
Air Filter Set.....	AS-2833-S	<b>R200W</b> (EXCAVATORS) CUMMINS 6BTA5.9		Cabin Air Filter.....	CA-28240
Fuel Filter.....	FC-1010	<b>R200W-3</b> (EXCAVATORS) 2006-UP		Air Filter Secondary.....	A-2832
Hydraulic Oil Filter.....	H-2725	Air Filter Primary.....	AS-2831	Air Filter Set.....	AS-2833-S
Hydraulic Oil Filter.....	H-2719	Air Filter Set.....	AS-1024-S	Air Filter Breather.....	A-71330
Hydraulic Oil Filter.....	HC-7940	Air Filter Breather.....	A-71330	Fuel Filter Secondary.....	FC-7903
Oil Filter Full Flow.....	C-2702	Fuel Filter.....	FC-1010	Fuel/Water Separator.....	SFC-5706
<b>R170W-7A</b> (EXCAVATORS) D04FD-TAA		Fuel/Water Separator.....	SFC-5706	Hydraulic Oil Filter.....	H-2719
Oil Filter Full Flow.....	C-56141	Hydraulic Oil Filter.....	H-2725	Hydraulic Oil Filter.....	HC-7940
<b>R170W-9</b> (EXCAVATORS) CUMMINS QSB6.7 , 2012		Hydraulic Oil Filter.....	HC-7940	<b>R210LC-7</b> (EXCAVATORS) CUMMINS 6BTA5.9-C210 , 2007-UP	
Cabin Air Filter.....	CA-28181	Oil Filter Full Flow.....	C-2702	Fuel/Water Separator.....	SFC-5706
<b>R180LC-3</b> (EXCAVATORS) CUMMINS 6BTS.9		<b>R200W-7</b> (EXCAVATORS) CUMMINS 6BTA5.9-C210 , 2007-UP		Fuel/Water Separator.....	SFC-5708
Air Filter Breather.....	A-71330	Fuel/Water Separator.....	SFC-5706	Oil Filter Full Flow.....	C-5714
Air Filter Secondary.....	A-6009	Oil Filter Full Flow.....	C-5714	<b>R210LC-7</b> (EXCAVATORS) CUMMINS 6BTS.9-C150 , 2007-UP	
Air Filter Set.....	AS-1024-S	<b>R210LC-3</b> (EXCAVATORS) HYUNDAI		Coolant Filter.....	WC-5703
Air Filter Primary.....	AS-1024			Fuel/Water Separator.....	SFC-5705
Fuel Filter Secondary.....	FC-7903			Oil Filter Full Flow.....	C-5715
Fuel Filter.....	FC-1010			Oil Filter By Pass.....	C-5718
Fuel/Water Separator.....	SFC-5706			<b>R210LC-7</b> (EXCAVATORS) CUMMINS NTC-400 (S/N: N60615729-UP) , 2007-UP	
Hydraulic Oil Filter.....	H-2719			Air Filter Breather.....	A-71330
Hydraulic Oil Filter.....	HC-7940			Air Filter Primary.....	AS-2831
Hydraulic Oil Filter.....	H-2725			Air Filter Set.....	AS-2833-S
Oil Filter Combination.....	0-1006			Fuel Filter Secondary.....	FC-7903
Oil Filter Full Flow.....	C-5704			Fuel/Water Separator.....	SFC-5706
				Hydraulic Oil Filter.....	H-2725
				Hydraulic Oil Filter.....	H-2719
				Hydraulic Oil Filter.....	HC-7940



MODEL/APPLICATION	SAKURA NO	MODEL/APPLICATION	SAKURA NO	MODEL/APPLICATION	SAKURA NO
<b>HYUNDAI</b>		<b>HYUNDAI</b>		<b>HYUNDAI</b>	
<b>R210LC-7</b> (EXCAVATORS) S/N: TIER II-UP , 2006-UP Air Filter Secondary..... A-2832 Air Filter Primary..... AS-2831 Air Filter Set..... AS-2833-S Fuel Filter Secondary..... FC-7903		<b>R250LC-3</b> (EXCAVATORS) CUMMINS 6BT5.9 Fuel Filter Secondary..... FC-7903 Fuel/Water Separator..... SFC-5706 Hydraulic Oil Filter..... H-2725 Hydraulic Oil Filter..... HC-7940 Hydraulic Oil Filter..... H-2719		Hydraulic Oil Filter..... H-2719 Hydraulic Oil Filter..... H-2725 Oil Filter Combination..... C-5723	
<b>R210LC-7A</b> (EXCAVATORS) CUMMINS QSB6.7 , 2008-UP Air Filter Breather..... A-71330 Fuel Filter..... FC-45010 Oil Filter Full Flow..... C-5708		<b>R250LC-7</b> (EXCAVATORS) CUMMINS 6BT5.9-C210 , 2007-UP Fuel/Water Separator..... SFC-5706 Oil Filter Full Flow..... C-5714		<b>R2800K</b> (EXCAVATORS) Oil Filter Full Flow..... O-1010	
<b>R210LC-7A</b> (EXCAVATORS) CUMMINS QSB6.7 , 2008 Cabin Air Filter..... CA-28240		<b>R250LC-7</b> (EXCAVATORS) CUMMINS 6BTAA5.9-C210 , 2007-UP Fuel/Water Separator..... SFC-5706 Oil Filter Full Flow..... C-5714		<b>R290LC</b> (EXCAVATORS) Air Filter Set..... AS-1024-S Air Filter Secondary..... A-6009 Air Filter Primary..... AS-1024 Coolant Filter..... WC-5711 Fuel Filter Secondary..... FC-7903 Fuel/Water Separator..... SFC-5706 Hydraulic Oil Filter..... HC-7940 Hydraulic Oil Filter..... H-2719 Oil Filter Combination..... C-5723	
<b>R210LC-7H</b> (EXCAVATORS) 2006-UP Air Filter Breather..... A-71330 Air Filter Secondary..... A-2832 Air Filter Primary..... AS-2831 Air Filter Set..... AS-2833-S Fuel Filter..... FC-1010 Hydraulic Oil Filter..... HC-7940 Hydraulic Oil Filter..... H-2725 Hydraulic Oil Filter..... H-2719 Oil Filter Combination..... O-1006		<b>R250LC-7</b> (EXCAVATORS) CUMMINS 6BTAA5.9-C210 , 2007-UP Fuel/Water Separator..... SFC-5706 Oil Filter Full Flow..... C-5714		<b>R290LC-3</b> (EXCAVATORS) CUMMINS 6CT8.3 Air Filter Secondary..... A-6009 Air Filter Primary..... AS-1024 Air Filter Set..... AS-1024-S Coolant Filter..... WC-5713 Coolant Filter..... WC-5711 Fuel Filter Secondary..... FC-7903 Fuel/Water Separator..... SFC-5706 Hydraulic Oil Filter..... HC-7940 Hydraulic Oil Filter..... H-2719 Oil Filter Combination..... C-5723	
<b>R210LC-7H</b> (EXCAVATORS) D6BT-C Fuel Filter Set..... FC-28200-S Fuel Filter Primary..... FC-28030		<b>R250LC-7</b> (EXCAVATORS) CUMMINS QSB6.7 , 2008-UP Fuel Filter..... FC-45010 Hydraulic Oil Filter..... HC-7940 Oil Filter Full Flow..... C-5708		<b>R290LC-3</b> (EXCAVATORS) HYUNDAI Air Filter Set..... AS-1024-S Air Filter Secondary..... A-6009 Air Filter Primary..... AS-1024 Coolant Filter..... WC-5713 Coolant Filter..... WC-5711 Fuel Filter Secondary..... FC-7903 Fuel/Water Separator..... SFC-5706 Hydraulic Oil Filter..... H-2719 Hydraulic Oil Filter..... H-2719 Oil Filter Combination..... C-5723	
<b>R210LC-9</b> (EXCAVATORS) CUMMINS QSB6.7 , 2008-UP Oil Filter Full Flow..... C-5708		<b>R250LC-7A</b> (EXCAVATORS) CUMMINS QSB6.7 , 2008-UP Fuel Filter..... FC-45010 Hydraulic Oil Filter..... HC-7940 Oil Filter Full Flow..... C-5708		<b>R290LC-3</b> (EXCAVATORS) HYUNDAI Air Filter Set..... AS-1024-S Air Filter Secondary..... A-6009 Air Filter Primary..... AS-1024 Coolant Filter..... WC-5713 Coolant Filter..... WC-5711 Fuel Filter Secondary..... FC-7903 Fuel/Water Separator..... SFC-5706 Hydraulic Oil Filter..... H-2719 Hydraulic Oil Filter..... HC-7940 Oil Filter Combination..... C-5723	
<b>R210LC-9</b> (EXCAVATORS) CUMMINS QSB6.7 Cabin Air Filter..... CA-28181		<b>R250NLC-7</b> (EXCAVATORS) CUMMINS 6BT5.9-C173 , 2007-UP Fuel/Water Separator..... SFC-5706 Oil Filter Full Flow..... C-5714		<b>R290LC-3</b> (EXCAVATORS) HYUNDAI Air Filter Set..... AS-1024-S Air Filter Secondary..... A-6009 Air Filter Primary..... AS-1024 Coolant Filter..... WC-5713 Coolant Filter..... WC-5711 Fuel Filter Secondary..... FC-7903 Fuel/Water Separator..... SFC-5706 Hydraulic Oil Filter..... H-2719 Hydraulic Oil Filter..... HC-7940 Oil Filter Combination..... C-5723	
<b>R210NLC-7</b> (EXCAVATORS) 2006-UP Air Filter Secondary..... A-2832 Air Filter Primary..... AS-2831 Air Filter Breather..... A-71330 Air Filter Set..... AS-2833-S Fuel Filter Secondary..... FC-7903 Hydraulic Oil Filter..... HC-7940 Hydraulic Oil Filter..... H-2719 Hydraulic Oil Filter..... H-2725		<b>R250NLC-7</b> (EXCAVATORS) CUMMINS 6BTAA5.9-C173 , 2007-UP Fuel/Water Separator..... SFC-5706 Oil Filter Full Flow..... C-5714		<b>R290LC-3</b> (EXCAVATORS) HYUNDAI Air Filter Set..... AS-1024-S Air Filter Secondary..... A-6009 Air Filter Primary..... AS-1024 Coolant Filter..... WC-5713 Coolant Filter..... WC-5711 Fuel Filter Secondary..... FC-7903 Fuel/Water Separator..... SFC-5706 Hydraulic Oil Filter..... H-2719 Hydraulic Oil Filter..... HC-7940 Oil Filter Combination..... C-5723	
<b>R210NLC-9</b> (EXCAVATORS) CUMMINS QSB6.7 Cabin Air Filter..... CA-28181		<b>R250NLC-7</b> (EXCAVATORS) CUMMINS QSB6.7-C215 , 2007-UP Fuel Filter..... FC-5725 Fuel/Water Separator..... SFC-5711		<b>R290LC-3</b> (EXCAVATORS) HYUNDAI Air Filter Secondary..... A-6009 Air Filter Primary..... AS-1024 Air Filter Set..... AS-1024-S Coolant Filter..... WC-5711 Fuel Filter Secondary..... FC-7903 Fuel/Water Separator..... SFC-5706 Hydraulic Oil Filter..... H-2719 Hydraulic Oil Filter..... HC-7940 Oil Filter Combination..... C-5723	
<b>R210W-9</b> (EXCAVATORS) CUMMINS QSB6.7 , 2012 Cabin Air Filter..... CA-28181		<b>R250LC-9</b> (EXCAVATORS) CUMMINS QSB6.7 , 2012 Cabin Air Filter..... CA-28181		<b>R290LC-3</b> (EXCAVATORS) HYUNDAI Air Filter Secondary..... A-6009 Air Filter Primary..... AS-1024 Air Filter Set..... AS-1024-S Coolant Filter..... WC-5711 Fuel Filter Secondary..... FC-7903 Fuel/Water Separator..... SFC-5706 Hydraulic Oil Filter..... H-2719 Hydraulic Oil Filter..... HC-7940 Oil Filter Combination..... C-5723	
<b>R220LC-7</b> (EXCAVATORS) CUMMINS 6BTAA5.9-C Air Filter Primary..... A-28840 Air Filter Set..... A-28840-S Air Filter Secondary..... A-28850		<b>R27Z-9</b> (EXCAVATORS) MITSUBISHI S3L2 Cabin Air Filter..... CA-28410		<b>R290LC-3</b> (EXCAVATORS) HYUNDAI Air Filter Secondary..... A-6009 Air Filter Primary..... AS-2831 Air Filter Breather..... A-71330	
		<b>R280LC</b> (EXCAVATORS) Air Filter Primary..... AS-1024 Air Filter Secondary..... A-6009 Air Filter Set..... AS-1024-S Coolant Filter..... WC-5711 Fuel Filter Secondary..... FC-7903 Fuel/Water Separator..... SFC-5706			

MODEL/APPLICATION	SAKURA NO	MODEL/APPLICATION	SAKURA NO	MODEL/APPLICATION	SAKURA NO
<b>HYUNDAI</b>		<b>HYUNDAI</b>		<b>HYUNDAI</b>	
<b>R290LC-7</b> (EXCAVATORS) S/N: TIER II-UP , 2006-UP		<b>R320LC-3</b> (EXCAVATORS) CUMMINS M11		Hydraulic Oil Filter.....	HC-7940
Hydraulic Oil Filter.....	H-2719	Coolant Filter.....	WC-5705	<b>R360LC-7</b> (EXCAVATORS) CUMMINS QSC8.3 , 2005	
Hydraulic Oil Filter.....	HC-7940	Fuel Filter Secondary.....	FC-7903	Hydraulic Oil Filter.....	H-28040
Oil Filter Full Flow.....	C-5708	Fuel/Water Separator.....	SFC-5706	<b>R360LC-7A</b> (EXCAVATORS) 2008-UP	
<b>R290LC-7</b> (EXCAVATORS) CUMMINS QSB5.9-C		Hydraulic Oil Filter.....	HC-7940	Air Filter Primary.....	A-28770
Air Filter Breather.....	A-71330	Hydraulic Oil Filter.....	H-2719	<b>R360LC-7A</b> (EXCAVATORS) CUMMINS QSL9-C280 , 2007-UP	
Air Filter Set.....	AS-2833-S	Oil Filter Combination.....	C-5723	Coolant Filter.....	WC-5712
Air Filter Secondary.....	A-2832	<b>R320LC-7</b> (EXCAVATORS) CUMMINS , 2005-UP		Fuel/Water Separator.....	SFC-5509-10
Air Filter Primary.....	AS-2831	Fuel Filter Secondary.....	FC-7903	<b>R380LC-9</b> (EXCAVATORS) CUMMINS QSL9 , 2012	
Coolant Filter.....	WC-5711	Fuel/Water Separator.....	SFC-5706	Cabin Air Filter.....	CA-28181
Fuel Filter Secondary.....	FC-7903	Hydraulic Oil Filter.....	H-2719	<b>R450LC-3</b> (EXCAVATORS) CUMMINS LTA10	
Fuel/Water Separator.....	SFC-5706	Hydraulic Oil Filter.....	HC-7940	Air Filter Set.....	A-28770-S
Hydraulic Oil Filter.....	H-2719	<b>R320LC-7A</b> (EXCAVATORS) CUMMINS QSC , 2008-UP		Air Filter Set.....	A-28730-S
Hydraulic Oil Filter.....	H-28040	Hydraulic Oil Filter.....	HC-7940	Air Filter Secondary.....	A-28780
Hydraulic Oil Filter.....	HC-7940	<b>R320NLC-7</b> (EXCAVATORS) CUMMINS 6CTAA8.3-C250 , 2007-UP		Air Filter Set.....	A-1841-S
Oil Filter Combination.....	C-5723	Air Filter Secondary.....	A-9206	Air Filter Secondary.....	A-5631
<b>R290LC-7A</b> (EXCAVATORS) CUMMINS QSB6.7 , 2007-UP		Coolant Filter.....	WC-5711	Air Filter Secondary.....	A-7967
Fuel Filter.....	FC-45010	Fuel/Water Separator.....	SFC-5706	Air Filter Primary.....	A-1013
Hydraulic Oil Filter.....	HC-7940	<b>R320NLC-7</b> (EXCAVATORS) CUMMINS QSC8.3-C250 , 2007-UP		Air Filter Primary.....	A-10134
Oil Filter Full Flow.....	C-5708	Air Filter Secondary.....	A-9206	Air Filter Primary.....	A-28770
<b>R290NLC-7</b> (EXCAVATORS) CUMMINS QSB5.9-C205 , 2005-UP		Coolant Filter.....	WC-5712	Air Filter Primary.....	A-28710
Oil Filter Full Flow.....	C-5708	Fuel/Water Separator.....	SFC-5706	Coolant Filter.....	WC-5713
<b>R290NLC-7A</b> (EXCAVATORS) CUMMINS QSB6.7-C220 , 2007-UP		<b>R320LC-9</b> (EXCAVATORS) CUMMINS QSC8.3 , 2012		Fuel/Water Separator Secondary..	SFC-1905-10
Fuel Filter.....	FC-5725	Cabin Air Filter.....	CA-28181	Fuel/Water Separator.....	SFC-5705
Fuel/Water Separator.....	SFC-5711	<b>R35Z-7A</b> (EXCAVATORS) YANMAR 3TNV88-BSHYB		Hydraulic Oil Filter.....	H-5609
Oil Filter Full Flow.....	C-5708	Hydraulic Oil Filter Suction.....	H-28100	Hydraulic Oil Filter.....	H-2719
<b>R290LC-9</b> (EXCAVATORS) CUMMINS QSB6.7 , 2012		<b>R 35 Z-9</b> (EXCAVATORS) YANMAR 3TNV88 , 2017		Oil Filter Combination.....	C-5723
Cabin Air Filter.....	CA-28181	Fuel Filter.....	F-28460	<b>R450LC-7</b> (EXCAVATORS) CUMMINS QSM11-C , 2005-UP	
<b>R305LC-7</b> (EXCAVATORS) 2006-UP		<b>R360LC-3</b> (EXCAVATORS) CUMMINS LTA10		Air Filter Primary.....	A-28770
Air Filter Set.....	AS-2833-S	Coolant Filter.....	WC-5713	Fuel/Water Separator.....	SFC-5709-10
Air Filter Secondary.....	A-2832	Fuel/Water Separator.....	SFC-5705	Hydraulic Oil Filter.....	HC-7940
Air Filter Primary.....	AS-2831	Fuel/Water Separator Secondary..	SFC-1905-10	Hydraulic Oil Filter.....	H-2719
Coolant Filter.....	WC-5711	Hydraulic Oil Filter.....	H-2719	<b>R450LC-7</b> (EXCAVATORS) CUMMINS QSM11-C , 2005	
Fuel Filter Secondary.....	FC-7903	Hydraulic Oil Filter.....	HC-7940	Air Filter Primary.....	A-28770
Fuel/Water Separator.....	SFC-5706	Oil Filter Combination.....	C-5723	Air Filter Set.....	A-28770-S
Hydraulic Oil Filter.....	H-2719	<b>R360LC-3</b> (EXCAVATORS) HYUNDAI D6AZ		Air Filter Secondary.....	A-28780
Hydraulic Oil Filter.....	HC-7940	Coolant Filter.....	WC-5713	<b>R450LC-7A</b> (EXCAVATORS) CUMMINS QSM11-C , 2008-UP	
<b>R320LC</b> (EXCAVATORS) CUMMINS LT10-C250 , 2007-UP		Fuel/Water Separator.....	SFC-5705	Air Filter Primary.....	A-28770
Coolant Filter.....	WC-5713	Fuel/Water Separator Secondary..	SFC-1905-10	Fuel/Water Separator Primary....	SFC-7912-30
Fuel/Water Separator.....	SFC-5705	Hydraulic Oil Filter.....	HC-7940	Fuel/Water Separator.....	SFC-5709-10
Oil Filter Combination.....	C-5723	Hydraulic Oil Filter.....	H-2719	<b>R450LC-7A</b> (EXCAVATORS) CUMMINS QSM11-C , 2008	
<b>R320LC</b> (EXCAVATORS) CUMMINS LT10		Oil Filter Combination.....	C-5723	Air Filter Primary.....	A-28770
Coolant Filter.....	WC-5713	<b>R360LC-7</b> (EXCAVATORS) CUMMINS QSC8.3 , 2005-UP		Air Filter Secondary.....	A-28780
Fuel/Water Separator Secondary..	SFC-1905-10	Fuel/Water Separator.....	SFC-5702-10	Air Filter Set.....	A-28770-S
Fuel/Water Separator.....	SFC-5705	Hydraulic Oil Filter.....	H-2719	<b>R450LC-7A</b> (EXCAVATORS) 2006-UP	
Hydraulic Oil Filter.....	H-2719	Hydraulic Oil Filter.....	HC-7940	Air Filter Primary.....	A-28770
Hydraulic Oil Filter.....	HC-7940	Oil Filter Combination.....	C-5723	Fuel/Water Separator.....	SFC-5709-10
Oil Filter Combination.....	C-5723				

MODEL/APPLICATION	SAKURA NO	MODEL/APPLICATION	SAKURA NO	MODEL/APPLICATION	SAKURA NO
<b>HYUNDAI</b>		<b>HYUNDAI</b>		<b>HYUNDAI</b>	
<b>R450LC-7A</b> (EXCAVATORS) 2006-UP		<b>R60CR-9</b> (EXCAVATORS) YANMAR 4TNV98		<b>ROBEX 140LC-7</b> (EXCAVATORS) CUMMINS B3.9C , 2005-UP	
Hydraulic Oil Filter.....	H-2719	Hydraulic Oil Filter.....	H-7930	Oil Filter Full Flow.....	C-5703
Hydraulic Oil Filter.....	HC-7940				
<b>R450LC</b> (EXCAVATORS) KOMATSU S6D125		<b>R800LC-7A</b> (EXCAVATORS) CUMMINS QSX15 , 2008-UP		<b>ROBEX 160LC-3</b> (EXCAVATORS) CUMMINS B3.9C	
Air Filter Primary.....	A-1013	Fuel/Water Separator Primary.....	SFC-7912-30	Fuel Filter Secondary.....	FC-7903
Air Filter Set.....	A-1841-S			Oil Filter Full Flow.....	C-5703
Air Filter Primary.....	A-10134	<b>R80-7</b> (EXCAVATORS) 2006-UP		<b>ROBEX 160NLC-3</b> (EXCAVATORS) CUMMINS 4B3.9	
Air Filter Secondary.....	A-5631	Air Filter.....	A-76410	Fuel Filter Secondary.....	FC-7903
Fuel Filter.....	FC-5602	Air Filter Breather.....	A-71330	Oil Filter Full Flow.....	C-5703
Hydraulic Oil Filter.....	H-5609	Air Filter Secondary.....	A-8599		
Oil Filter Full Flow.....	C-5701	Air Filter Set.....	A-76410-S	<b>ROBEX 170W-3</b> (EXCAVATORS) CUMMINS 6BTA5.9	
		Hydraulic Oil Filter.....	H-2719	Air Filter Primary.....	AS-1024
<b>R4500LC-3A</b> (EXCAVATORS) 2006-UP		<b>R8007AFS</b> (EXCAVATORS)		Air Filter Set.....	AS-1024-S
Air Filter Primary.....	A-28770	Fuel/Water Separator.....	SFC-28080	Air Filter Secondary.....	A-6009
				Fuel Filter Secondary.....	FC-7903
<b>R500LC-7</b> (EXCAVATORS) 2006-UP		<b>R800LC-9</b> (EXCAVATORS) CUMMINS QSX15		Oil Filter Full Flow.....	C-5704
Air Filter Primary.....	A-28770	Fuel/Water Separator.....	SFC-28080		
Fuel/Water Separator.....	SFC-5709-10	<b>R95W-3</b> (EXCAVATORS) MITSUBISHI		<b>ROBEX 180LC-2</b> (EXCAVATORS) CUMMINS 6BT5.9	
Hydraulic Oil Filter.....	H-2719	Air Filter Breather.....	A-71330	Air Filter Secondary.....	A-6009
Hydraulic Oil Filter.....	HC-7940	Fuel Filter.....	FC-1007	Air Filter Set.....	AS-1024-S
		Hydraulic Oil Filter.....	H-2719	Air Filter Primary.....	AS-1024
<b>R500LC-7A</b> (EXCAVATORS) 2008-UP		Oil Filter Full Flow.....	C-5811	Fuel Filter Secondary.....	FC-7903
Air Filter Primary.....	A-28770	<b>ROBEX 120W</b> (EXCAVATORS) CUMMINS 4BTA3.9		Oil Filter Full Flow.....	C-5704
Fuel/Water Separator Primary.....	SFC-7912-30	Air Filter Primary.....	AS-8502	<b>ROBEX 180LC-2</b> (EXCAVATORS) CUMMINS B5.9C	
Fuel/Water Separator.....	SFC-5709-10	Air Filter Set.....	AS-8502-S	Air Filter Secondary.....	A-6009
		Fuel Filter Secondary.....	FC-7903	Air Filter Set.....	AS-1024-S
<b>R500LC-7A</b> (EXCAVATORS) 2006-UP		Fuel/Water Separator.....	SFC-5706	Air Filter Primary.....	AS-1024
Air Filter Primary.....	A-28770	Oil Filter Full Flow.....	C-5703	Fuel Filter Secondary.....	FC-7903
Fuel/Water Separator.....	SFC-5709-10	<b>ROBEX 130LC</b> (EXCAVATORS) CUMMINS 4BTA3.9		Oil Filter Full Flow.....	C-5704
		Air Filter Set.....	AS-8502-S	<b>ROBEX 180NLC-3</b> (EXCAVATORS) CUMMINS 6B5.9	
<b>R500LC-7A</b> (EXCAVATORS) 2006-UP		Air Filter Primary.....	AS-8502	Fuel Filter Secondary.....	FC-7903
Air Filter Primary.....	A-28770	Air Filter Secondary.....	A-5437	Oil Filter Full Flow.....	C-5704
Fuel/Water Separator.....	SFC-5709-10	Fuel Filter Secondary.....	FC-7903	<b>ROBEX 200LC</b> (EXCAVATORS) CUMMINS 6BT5.9	
Hydraulic Oil Filter.....	HC-7940	Fuel/Water Separator.....	SFC-5706	Air Filter Set.....	AS-8502-S
Hydraulic Oil Filter.....	H-2719	Hydraulic Oil Filter.....	H-2719	Air Filter Primary.....	AS-8502
		Hydraulic Oil Filter.....	HC-7940	Air Filter Secondary.....	A-6009
<b>R55-3</b> (EXCAVATORS) YANMAR , 2006-UP		Oil Filter Full Flow.....	C-5703	Air Filter Primary.....	AS-1024
Air Filter Breather.....	A-71330	<b>ROBEX 130LCM-3</b> (EXCAVATORS) CUMMINS 4BTA3.9		Air Filter Set.....	AS-1024-S
Fuel Filter.....	FC-1016	Fuel Filter Secondary.....	FC-7903	Fuel Filter Secondary.....	FC-7903
Hydraulic Oil Filter.....	H-2719	Oil Filter Full Flow.....	C-5703	Fuel/Water Separator.....	SFC-5706
Oil Filter Full Flow.....	C-8012	Hydraulic Oil Filter.....	H-2719	Hydraulic Oil Filter.....	H-2725
		Hydraulic Oil Filter.....	HC-7940	Hydraulic Oil Filter.....	H-2719
<b>R55-7</b> (EXCAVATORS) 2006-UP		Oil Filter Full Flow.....	C-5703	Oil Filter Full Flow.....	C-5704
Air Filter Primary.....	A-8505	<b>ROBEX 130W</b> (EXCAVATORS) CUMMINS		<b>ROBEX 200NLC-3</b> (EXCAVATORS) CUMMINS 6BT5.9	
Air Filter Secondary.....	A-8599	Air Filter Primary.....	AS-8502	Fuel Filter Secondary.....	FC-7903
Air Filter Breather.....	A-71330	Air Filter Set.....	AS-8502-S	Oil Filter Full Flow.....	C-5704
Hydraulic Oil Filter.....	H-2719	Air Filter Secondary.....	A-5437	<b>ROBEX 200W</b> (EXCAVATORS) CUMMINS 6BT5.9	
Oil Filter Full Flow.....	C-1720	Fuel Filter Secondary.....	FC-7903	Air Filter Set.....	AS-8502-S
		Fuel/Water Separator.....	SFC-5706	Air Filter Primary.....	AS-8502
<b>R55W-3</b> (EXCAVATORS) 2006-UP		Hydraulic Oil Filter.....	H-5609	Fuel Filter Secondary.....	FC-7903
Air Filter Breather.....	A-71330	Oil Filter Full Flow.....	C-5703		
Fuel Filter.....	FC-1016				
Hydraulic Oil Filter.....	H-2719				
Oil Filter Full Flow.....	C-8012				



MODEL/APPLICATION	SAKURA NO	MODEL/APPLICATION	SAKURA NO	MODEL/APPLICATION	SAKURA NO
<b>HYUNDAI</b>		<b>HYUNDAI</b>		<b>HYUNDAI</b>	
<b>ROBEX 200W</b> (EXCAVATORS) CUMMINS 6BT5.9		Fuel/Water Separator.....	SFC-5706	<b>ROBEX 280</b> (EXCAVATORS) CUMMINS 6CT8.3	
Fuel/Water Separator.....	SFC-5706	Hydraulic Oil Filter.....	HC-7940	Fuel Filter Secondary.....	FC-7903
Oil Filter Full Flow.....	C-5704	Hydraulic Oil Filter.....	H-2719	<b>ROBEX 95W-3</b> (EXCAVATORS) MITSUBISHI S4DT	
<b>ROBEX 210-3</b> (EXCAVATORS) CUMMINS 6BT5.9		<b>ROBEX 290LC-7</b> (EXCAVATORS) CUMMINS QSB5.9-C , 2005-UP		Fuel Filter.....	FC-1007
Fuel Filter Secondary.....	FC-7903	Fuel Filter Secondary.....	FC-7903	<b>ROBEX 95W-3</b> (EXCAVATORS) PERKINS 1004-42	
Hydraulic Oil Filter.....	H-2719	<b>ROBEX 320-3</b> (EXCAVATORS) CUMMINS 6CTA8.3		Oil Filter Full Flow.....	C-5102
Hydraulic Oil Filter.....	HC-7940	Fuel Filter Secondary.....	FC-7903	<b>ROBEX 215-7</b> (EXCAVATORS) D6BT-C	
Oil Filter Full Flow.....	C-5704	Fuel/Water Separator.....	SFC-5708	Fuel Filter Secondary.....	FC-28040
<b>ROBEX 210LC-3</b> (EXCAVATORS) CUMMINS 6BT5.9		Fuel/Water Separator.....	SFC-5706	<b>ROBEX 375LC-7H</b> (EXCAVATORS) HYUNDAI D6AC-C	
Air Filter Primary.....	AS-1024	<b>ROBEX 320LC</b> (EXCAVATORS) CUMMINS LT10		Oil Filter Full Flow.....	C-2811
Air Filter Set.....	AS-1024-S	Fuel Filter.....	FC-5720		
Air Filter Secondary.....	A-6009	Oil Filter Combination.....	C-5723		
Fuel Filter Secondary.....	FC-7903	<b>ROBEX 320LC-3</b> (EXCAVATORS) CUMMINS 6CTA8.3			
Hydraulic Oil Filter.....	HC-7940	Fuel Filter.....	FC-5702		
Hydraulic Oil Filter.....	H-2719	Fuel Filter Secondary.....	FC-7903		
Oil Filter Full Flow.....	C-5704	<b>ROBEX 320LC-3</b> (EXCAVATORS) CUMMINS M11			
<b>ROBEX 210LC-7</b> (EXCAVATORS) CUMMINS B5.9 , 2005-UP		Coolant Filter.....	WC-5705		
Air Filter Set.....	AS-2833-S	Fuel Filter Secondary.....	FC-7903		
Air Filter Primary.....	AS-2831	Oil Filter Combination.....	C-5723		
Air Filter Secondary.....	A-2832	<b>ROBEX 320NLC-3</b> (EXCAVATORS) CUMMINS 6CTA8.3			
Fuel Filter Secondary.....	FC-7903	Fuel Filter Secondary.....	FC-7903		
Fuel/Water Separator.....	SFC-5706	Fuel/Water Separator.....	SFC-5706		
Hydraulic Oil Filter.....	HC-7940	Fuel/Water Separator.....	SFC-5708		
Hydraulic Oil Filter.....	H-2719	<b>ROBEX 360LC-3</b> (EXCAVATORS) CUMMINS LTA10			
Oil Filter Full Flow.....	C-5704	Coolant Filter.....	WC-5712		
<b>ROBEX 280LC</b> (EXCAVATORS) CUMMINS 6CT8.3		Fuel Filter.....	FC-5702		
Air Filter Secondary.....	A-6009	<b>ROBEX 360LC-3</b> (EXCAVATORS) HYUNDAI D6AZ			
Air Filter Set.....	AS-1024-S	Coolant Filter.....	WC-5712		
Air Filter Primary.....	AS-1024	Fuel/Water Separator Secondary..	SFC-1905-10		
Coolant Filter.....	WC-5711	Fuel/Water Separator.....	SFC-5705		
Fuel Filter Secondary.....	FC-7903	Oil Filter Combination.....	C-5723		
Fuel/Water Separator.....	SFC-5706	<b>ROBEX 420LC</b> (EXCAVATORS) KOMATSU S6D125			
Hydraulic Oil Filter.....	H-2725	Air Filter Secondary.....	A-5631		
Hydraulic Oil Filter.....	H-2719	Air Filter Primary.....	A-10134		
Oil Filter Combination.....	C-5723	Air Filter Primary.....	A-1013		
<b>ROBEX 290LC</b> (EXCAVATORS) CUMMINS 6CT8.3		Air Filter Set.....	A-1841-S		
Air Filter Primary.....	AS-1024	Fuel Filter.....	FC-5602		
Air Filter Set.....	AS-1024-S	Hydraulic Oil Filter.....	H-5609		
Air Filter Secondary.....	A-6009	Oil Filter Full Flow.....	C-5701		
Coolant Filter.....	WC-5711	<b>ROBEX 450LC-3</b> (EXCAVATORS) CUMMINS LTA10			
Fuel Filter Secondary.....	FC-7903	Fuel Filter.....	FC-5702		
Fuel/Water Separator.....	SFC-5706	Hydraulic Oil Filter.....	H-2719		
Hydraulic Oil Filter.....	H-2719	<b>ROBEX 130W-3</b> (EXCAVATORS) CUMMINS 4BTA3.9 , 2004-UP			
Hydraulic Oil Filter.....	HC-7940	Fuel Filter Secondary.....	FC-7903		
Oil Filter Combination.....	C-5723	Oil Filter Full Flow.....	C-5703		
<b>ROBEX 290LC-3LR</b> (EXCAVATORS) CUMMINS 6CT8.3					
Air Filter Primary.....	AS-1024				
Air Filter Secondary.....	A-6009				
Air Filter Set.....	AS-1024-S				
Fuel Filter Secondary.....	FC-7903				
Fuel/Water Separator.....	SFC-5708				

# Technical Specification

**B**

# Sakura Filter

# Technical Specification

**A-1013** Air Filter Primary Metal End Cap Element



ISUZU 1-14214126-0  
ISUZU 1-14215-181-0  
ISUZU 1-86750-309-0  
NISSAN 16546-96071  
NISSAN 16546-99218  
Secondary Filter uses A-5631  
Set Filter uses A-1841-S  
H 1 : 395 (mm)  
H 2 : 382 (mm)  
OD 1 : 276 (mm)  
OD 2 : 276 (mm)  
ID 1 : 165 (mm)  
ID 2 : 23 (mm)

CONT : 4  
VOL : 0.154

Note : Is a Primary Air Filter for A-5631,A-7607

**A-28720** Air Filter Secondary Metal End Cap Element



HYUNDAI 11N8-22150

Primary Filter uses A-28710  
Set Filter uses A-28730-S  
H 1 : 495 (mm)  
H 2 : 482 (mm)  
OD 1 : 162.5 (mm)  
OD 2 : 163 (mm)  
ID 1 : 134 (mm)  
ID 2 : 19 (mm)

CONT : 9  
VOL : 0.152

**A-28840** Air Filter Primary Metal End Cap Element



OWJ 11N6-T0001R(P)

Secondary Filter uses A-28850  
Set Filter uses A-28840-S  
H 1 : 434.5 (mm)  
H 2 : 425 (mm)  
OD 1 : 234 (mm)  
OD 2 : 234 (mm)  
ID 1 : 123 (mm)  
ID 2 : 17.5 (mm)

CONT : 4  
VOL : 0.117

**A-10134** Air Filter Primary Metal End Cap Element



MITSUBISHI ME 063130

H 1 : 395 (mm)  
H 2 : 382 (mm)  
OD 1 : 276 (mm)  
OD 2 : 276 (mm)  
ID 1 : 165 (mm)  
ID 2 : 23 (mm)

CONT : 1  
VOL : 0.035

Note : Flame Retardant version from A-1013

**A-28730-S** Air Filter Set Metal End Cap Element



HYUNDAI 11N8-22140+11N8-22150

Primary Filter uses A-28710  
Secondary Filter uses A-28720  
H 1 : 503 (mm)  
H 2 : 490 (mm)  
OD 1 : 276 (mm)  
OD 2 : 275 (mm)  
ID 1 : 134 (mm)  
ID 2 : 19 (mm)

CONT : 1  
VOL : 0.047

**A-28840-S** Air Filter Set Metal End Cap Element



OWJ 11N6-T0001R(SET)

Primary Filter uses A-28840  
Secondary Filter uses A-28850  
H 1 : 343.5 (mm)  
H 2 : 425 (mm)  
OD 1 : 234 (mm)  
OD 2 : 234 (mm)  
ID 1 : 100 (mm)  
ID 2 : 18 (mm)

CONT : 4  
VOL : 0.117

**A-1841-S** Air Filter Set Metal End Cap Element



NISSAN 16546-96070  
HITACHI 4288963+4288964  
KOMATSU 600-181-1600

Primary Filter uses A-1013  
Secondary Filter uses A-5631  
H 1 : 395 (mm)  
H 2 : 382 (mm)  
OD 1 : 276 (mm)  
OD 2 : 276 (mm)  
ID 1 : 165 (mm)  
ID 2 : 23 (mm)

CONT : 4  
VOL : 0.163

**A-28770** Air Filter Primary Metal End Cap Element



HYUNDAI 11NB-20120  
HYUNDAI 14L1-01560

Secondary Filter uses A-28780  
Set Filter uses A-28770-S  
H 1 : 558 (mm)  
H 2 : 545 (mm)  
OD 1 : 307 (mm)  
OD 2 : 307 (mm)  
ID 1 : 197 (mm)  
ID 2 : 17 (mm)

CONT : 1  
VOL : 0.067

**A-28850** Air Filter Secondary Metal End Cap Element



OWJ 11N6-T0001R(S)  
TATA 2786 0913 9911

Primary Filter uses A-28840  
Set Filter uses A-28840-S  
H 1 : 360 (mm)  
H 2 : 352.5 (mm)  
OD 1 : 120 (mm)  
OD 2 : 120 (mm)  
ID 1 : 100 (mm)  
ID 2 : 18 (mm)

CONT : 9  
VOL : 0.059

**A-2832** Air Filter Secondary Metal End Cap Element



HYUNDAI 11EM-21051

Primary Filter uses AS-2831  
Set Filter uses AS-2833-S  
H 1 : 489 (mm)  
H 2 : 476 (mm)  
OD 1 : 133.5 (mm)  
OD 2 : 133.5 (mm)  
ID 1 : 105 (mm)  
ID 2 : 17 (mm)

CONT : 9  
VOL : 0.101

**A-28770-S** Air Filter Set Metal End Cap Element



HYUNDAI 11NB-20120+11NB-20130  
HYUNDAI 14L1-01560+14L1-01570

Primary Filter uses A-28770  
Secondary Filter uses A-28780  
H 1 : 558 (mm)  
H 2 : 545 (mm)  
OD 1 : 307 (mm)  
OD 2 : 307 (mm)  
ID 1 : 153 (mm)  
ID 2 : 17 (mm)

CONT : 1  
VOL : 0.067

**A-5437** Air Filter Secondary Metal End Cap Element



CASE 1129112-C1  
FURUKAWA 1129112C1

Primary Filter uses AS-8502  
Set Filter uses AS-8502-S  
H 1 : 365 (mm)  
H 2 : 355 (mm)  
OD 1 : 104 (mm)  
OD 2 : 104 (mm)  
ID 1 : 74 (mm)  
ID 2 : 17 (mm)

CONT : 25  
VOL : 0.141

**A-28710** Air Filter Primary Metal End Cap Element



HYUNDAI 11N8-22140

Secondary Filter uses A-28720  
Set Filter uses A-28730-S  
H 1 : 503 (mm)  
H 2 : 490 (mm)  
OD 1 : 276 (mm)  
OD 2 : 275 (mm)  
ID 1 : 165 (mm)  
ID 2 : 19 (mm)

CONT : 1  
VOL : 0.047

**A-28780** Air Filter Secondary Metal End Cap Element



HYUNDAI 11NB-20130  
HYUNDAI 14L1-01570

Primary Filter uses A-28770  
Set Filter uses A-28770-S  
H 1 : 534 (mm)  
H 2 : 521.5 (mm)  
OD 1 : 194 (mm)  
OD 2 : 194 (mm)  
ID 1 : 153 (mm)  
ID 2 : 17 (mm)

CONT : 9  
VOL : 0.261

**A-5631** Air Filter Secondary Metal End Cap Element



ISUZU 1-14215087-0  
NISSAN 16546-96072  
HITACHI 4288964

Primary Filter uses A-1013  
Set Filter uses A-1841-S  
H 1 : 362 (mm)  
H 2 : 349 (mm)  
OD 1 : 162.5 (mm)  
OD 2 : 163 (mm)  
ID 1 : 134 (mm)  
ID 2 : 17 (mm)

CONT : 9  
VOL : 0.110



# Sakura Filter

# Technical Specification

**A-6009** Air Filter Secondary Metal End Cap Element



LOESING 020941  
NISSAN 16546-96004  
KOBELCO 2451U206-3  
KOMATSU 600-181-8360  
ISUZU 9-14215017-0  
Primary Filter uses AS-1024  
Set Filter uses AS-1024-S  
H 1 : 397 (mm)  
H 2 : 397 (mm)  
OD 1 : 146 (mm)  
OD 2 : 166.5 (mm)  
ID 1 : 88 (mm)  
ID 2 : 17 (mm)

CONT : 9  
VOL : 0.101

16

**A-6903-S** Air Filter Set Metal End Cap Element



LOESING 021752+020877  
INGERSOLL RAND  
3013211+3013210

Primary Filter uses A-6903  
Secondary Filter uses A-6902  
H 1 : 622.7 (mm)  
H 2 : 610 (mm)  
OD 1 : 324 (mm)  
OD 2 : 324 (mm)  
ID 1 : 212 (mm)  
ID 2 : 23 (mm)

CONT : 1  
VOL : 0.073

21

**A-8505** Air Filter Primary Soft PU end cap Element



OPEL 1#123 84 075  
OPEL 1-12384075  
SUNWARD 730403000155

Secondary Filter uses A-8599  
Set Filter uses A-8602-S  
H 1 : 312 (mm)  
H 2 : 304 (mm)  
OD 1 : 127.5 (mm)  
OD 2 : 127.5 (mm)  
ID 1 : 83 (mm)

CONT : 16  
VOL : 0.112

Note : For Flame Retardant version use A-76410

26

**A-6703** Air Filter Primary Soft PU end cap Element

MERCEDES-BENZ 004 094 04 04  
MASSEY-FERGUSON 3901475M1  
BOBCAT 6910725  
LIEBHERR 761 1451

Secondary Filter uses A-6705  
Set Filter uses A-6706-S  
H 1 : 375 (mm)  
H 2 : 342 (mm)  
OD 1 : 159 (mm)  
OD 2 : 159 (mm)  
ID 1 : 94 (mm)

CONT : 9  
VOL : 0.118

17

**A-71330** Air Filter Breather Hard PU end cap Element



VOLVO 14500233  
KOMATSU 207-60-51310  
HYUNDAI 31EE-02110  
NEW HOLLAND (CNH) 47587350  
J.C.BAMFORD KRJ3461

H 1 : 39 (mm)  
H 2 : 31.5 (mm)  
OD 1 : 54.5 (mm)  
OD 2 : 54.5 (mm)  
ID 1 : 31 (mm)  
ID 2 : 31 (mm)

CONT : 100  
VOL : 0.017

22

**A-8599** Air Filter Secondary Soft PU end cap Element



KUBOTA 119005-12571  
CASE 133721A1  
HITACHI 4326841  
XCMG 819908758

Primary Filter uses A-8505  
Set Filter uses A-8602-S  
H 1 : 303.5 (mm)  
H 2 : 298 (mm)  
OD 1 : 83 (mm)  
OD 2 : 79 (mm)  
ID 1 : 64 (mm)

CONT : 25  
VOL : 0.076

Note : Is a Secondary Air filter for A-5669,A-8505

27

**A-6705** Air Filter Secondary Soft PU end cap Element

KHD(KLOCKNER-HUMBOLT-DEUTZ ) 0441 5906  
VOLVO (TRUCK/VCE/VME/PENTA) 11705111  
MASSEY-FERGUSON 3901476M1  
Primary Filter uses A-6703  
Set Filter uses A-6706-S  
H 1 : 360 (mm)  
OD 1 : 85.6 (mm)  
OD 2 : 85 (mm)  
ID 1 : 71 (mm)

CONT : 25  
VOL : 0.099

18

**A-76410** Air Filter Soft PU end cap Element



HYUNDAI 11FK-20080  
CASE 133720A1  
TOYOTA 17741U-2100-71  
LOESING 20666  
JOHN DEERE RE68043

H 1 : 312 (mm)  
H 2 : 304 (mm)  
OD 1 : 127.5 (mm)  
OD 2 : 127.5 (mm)  
ID 1 : 83 (mm)

CONT : 25  
VOL : 0.169

Note : Flame Retardant version of A-8505

23

**A-8650** Air Filter Primary Soft PU end cap Element



JOHN DEERE F434394  
CASE IH275809A1

Secondary Filter uses A-8651  
Set Filter uses A-8652-S  
H 1 : 524 (mm)  
H 2 : 512 (mm)  
OD 1 : 280 (mm)  
OD 2 : 280 (mm)  
ID 1 : 148 (mm)

CONT : 1  
VOL : 0.047

Note : Is a long life version of A-5102

28

**A-6902** Air Filter Secondary Metal End Cap Element



LOESING 020877  
CUMMINS 3013211  
INGERSOLL RAND 35123520  
CATERPILLAR 3I-0095

Primary Filter uses A-6903  
Set Filter uses A-6903-S  
H 1 : 572 (mm)  
H 2 : 559 (mm)  
OD 1 : 209.5 (mm)  
OD 2 : 209.5 (mm)  
ID 1 : 180.5 (mm)  
ID 2 : 23 (mm)

CONT : 9  
VOL : 0.265

19

**A-76410-S** Air Filter Set Soft PU end cap Element



CASE 133720A1+133721A1  
DAEWOO A213939+A213938  
JOHN DEERE RE68048+RE68049

Primary Filter uses A-76410  
Secondary Filter uses A-8599  
H 1 : 312 (mm)  
H 2 : 304 (mm)  
OD 1 : 127.5 (mm)  
OD 2 : 127.5 (mm)  
ID 1 : 83 (mm)

CONT : 25  
VOL : 0.169

24

**A-8652-S** Air Filter Set Soft PU end cap Element



JOHN DEERE F434394 + F434395

Primary Filter uses A-8650  
Secondary Filter uses A-8651  
H 1 : 524 (mm)  
H 2 : 512 (mm)  
OD 1 : 280 (mm)  
OD 2 : 280 (mm)  
ID 1 : 148 (mm)

CONT : 1  
VOL : 0.047

Note : Is a long life version of A-5102-S

29

**A-6903** Air Filter Primary Metal End Cap Element



LOESING 021752  
CUMMINS 3013210  
INGERSOLL RAND 35123512  
CATERPILLAR 3I-0802

Secondary Filter uses A-6902  
Set Filter uses A-6903-S  
H 1 : 623 (mm)  
H 2 : 610 (mm)  
OD 1 : 324 (mm)  
OD 2 : 324 (mm)  
ID 1 : 212 (mm)  
ID 2 : 23 (mm)

CONT : 1  
VOL : 0.076

20

**A-7967** Air Filter Secondary Metal End Cap Element



LOESING 021706  
ISUZU 1-14215089-0  
NISSAN 16546-96065  
KOBELCO 2446U250S-2

Primary Filter uses A-1828  
Set Filter uses A-1840-S  
H 1 : 496 (mm)  
H 2 : 483 (mm)  
OD 1 : 162 (mm)  
OD 2 : 162 (mm)  
ID 1 : 134 (mm)  
ID 2 : 17 (mm)

CONT : 9  
VOL : 0.152

25

**A-9206** Air Filter Secondary Metal End Cap Element



CATERPILLAR 3I-0124  
TEREX 9038408

Primary Filter uses A-9204  
Set Filter uses A-9204-S  
H 1 : 318 (mm)  
H 2 : 305 (mm)  
OD 1 : 151 (mm)  
OD 2 : 151 (mm)  
ID 1 : 123 (mm)  
ID 2 : 23 (mm)

CONT : 9  
VOL : 0.098

30

# Sakura Filter

# Technical Specification

**AS-1024** Air Filter Primary Metal End Cap Element With Sleeve



LOESING 020910  
NISSAN 16546-96003  
NISSAN 16546-96015  
NISSAN 16546-96026

Secondary Filter uses A-6009  
Set Filter uses AS-1024-S

H 1 : 419 (mm)  
H 2 : 406 (mm)  
OD 1 : 254 (mm)  
OD 2 : 201.5 (mm)  
ID 1 : 135.5 (mm)  
ID 2 : 17 (mm)

CONT : 1  
VOL : 0.031

31

**AS-8502-S** Air Filter Set Metal End Cap Element With Sleeve



FURUKAWA 1129111C1+1129112C1

Primary Filter uses AS-8502  
Secondary Filter uses A-5437

H 1 : 392 (mm)  
H 2 : 381 (mm)  
OD 1 : 225 (mm)  
OD 2 : 174 (mm)  
ID 1 : 107.5 (mm)  
ID 2 : 17 (mm)

CONT : 4  
VOL : 0.101

36

**C-2811** Oil Filter Full Flow Spin-On



HYUNDAI 26312-83C10

H 1 : 243 (mm)  
OD 1 : 136 (mm)  
Thread Size : M46X2-6H  
Gasket Type : Square

CONT : 6  
VOL : 0.027

41

**AS-1024-S** Air Filter Set Metal End Cap Element With Sleeve



LOESING 020910+020941  
FIAT 1930751+1930790  
KOMATSU 6131-82-7011  
FIAT 70684732+1930790  
JOHN DEERE T46316+T46317

Primary Filter uses AS-1024  
Secondary Filter uses A-6009

H 1 : 419 (mm)  
H 2 : 406 (mm)  
OD 1 : 254 (mm)  
OD 2 : 201.5 (mm)  
ID 1 : 135.5 (mm)  
ID 2 : 17 (mm)

CONT : 1  
VOL : 0.031

32

**C-1511** Oil Filter Full Flow Spin-On



ISUZU 8-94217272-0  
ISUZU 8-94360426-0  
ISUZU 8-94430983-0  
SANY A222100000569

H 1 : 100 (mm)  
OD 1 : 90 (mm)  
Thread Size : M20X1.5-6H  
BPV (kg/cm2) : 1.0  
ADBV : YES  
Gasket Type : Round

CONT : 25  
VOL : 0.029

37

**C-5102** Oil Filter Full Flow Spin-On



PERKINS 26540347  
PERKINS 2654407  
LIUGONG 53C0324

H 1 : 168 (mm)  
OD 1 : 93 (mm)  
Thread Size : 3/4-16 UNF-2B  
BPV (kg/cm2) : 1.0  
ADBV : YES  
Gasket Type : Square

CONT : 25  
VOL : 0.050

42

**AS-2831** Air Filter Primary Metal End Cap Element With Sleeve



HYUNDAI 11EM-21041

Secondary Filter uses A-2832  
Set Filter uses AS-2833-S

H 1 : 513 (mm)  
H 2 : 490 (mm)  
OD 1 : 254 (mm)  
OD 2 : 201.6 (mm)  
ID 1 : 135.5 (mm)  
ID 2 : 17 (mm)

CONT : 1  
VOL : 0.037

33

**C-1538** Oil Filter Full Flow Spin-On



HOLDEN 8-9421-7272-2

H 1 : 95 (mm)  
OD 1 : 93 (mm)  
Thread Size : M20X1.5-6H  
BPV (kg/cm2) : 1.0  
ADBV : YES  
Gasket Type : Square

CONT : 25  
VOL : 0.037

Note : C-1503,C-1511 (bottom plate difference)

38

**C-5614** Oil Filter Full Flow Spin-On



mitsubishi 32540-21600  
KOMATSU 6136-51-5120  
KOMATSU 6136-51-5121

H 1 : 171 (mm)  
OD 1 : 108 (mm)  
Thread Size : 1 1/8-16 UNF-2B  
BPV (kg/cm2) : 2.0  
Gasket Type : Square

CONT : 12  
VOL : 0.035

43

**AS-2833-S** Air Filter Set Metal End Cap Element With Sleeve



HYUNDAI 11EM-21041+11EM-21051

Primary Filter uses AS-2831  
Secondary Filter uses A-2832

H 1 : 513 (mm)  
H 2 : 490 (mm)  
OD 1 : 254 (mm)  
OD 2 : 201.6 (mm)  
ID 1 : 135.5 (mm)  
ID 2 : 17 (mm)

CONT : 4  
VOL : 0.152

34

**C-1720** Oil Filter Full Flow Spin-On



TCM 12163-82302  
YANMAR 129150-35152

H 1 : 100 (mm)  
OD 1 : 90 (mm)  
Thread Size : M20X1.5-6H  
BPV (kg/cm2) : 1.0  
ADBV : YES  
Gasket Type : Round

CONT : 36  
VOL : 0.040

39

**C-56141** Oil Filter Full Flow Spin-On



HYUNDAI XJAF-02362

H 1 : 220 (mm)  
OD 1 : 108 (mm)  
Thread Size : 1 1/8-16 UNF-2B  
BPV (kg/cm2) : 2.0  
Gasket Type : Square

CONT : 12  
VOL : 0.042

44

**AS-8502** Air Filter Primary Metal End Cap Element With Sleeve



FURUKAWA 1129111C1

Secondary Filter uses A-5437  
Set Filter uses AS-8502-S

H 1 : 392 (mm)  
H 2 : 381 (mm)  
OD 1 : 225 (mm)  
OD 2 : 174 (mm)  
ID 1 : 107.5 (mm)  
ID 2 : 17 (mm)

CONT : 4  
VOL : 0.107

35

**C-2702** Oil Filter Full Flow Spin-On



KOBELCO 2451U309-1  
HITACHI 4183853  
HITACHI 4439863

H 1 : 150 (mm)  
OD 1 : 102 (mm)  
Thread Size : 1-12 UNF-2B  
BPV (kg/cm2) : 2.0 - 2.5  
ADBV : YES  
Gasket Type : Square

CONT : 12  
VOL : 0.027

40

**C-5701** Oil Filter Full Flow Spin-On Cellulose media



HITACHI 4085913  
KOMATSU 600-211-1231

H 1 : 286 (mm)  
OD 1 : 118 (mm)  
Thread Size : 1 1/2-12 UNF-2B  
Gasket Type : Square

CONT : 10  
VOL : 0.055

Note : related to:C-5605,C-5731,C-5715(short versions)

45

**C-5703** Oil Filter Full Flow Spin-On



HYUNDAI 11E1-70110  
CUMMINS 3903224  
LIUGONG 40C0677  
KOMATSU 6732-51-5140  
CASE J908616

H 1 : 135 (mm)  
OD 1 : 93 (mm)  
Thread Size : 1-16 UNF-2B  
Gasket Type : Square

CONT : 12  
VOL : 0.018

46

**C-5715** Oil Filter Full Flow Spin-On Cellulose media



MTU 0031843001  
LOESING 020186  
MITSUBISHI 37540-01101  
CUMMINS 3889310  
KOMATSU CULF-670

H 1 : 246 (mm)  
OD 1 : 118 (mm)  
Thread Size : 1 1/2-12 UNF-2B  
Gasket Type : Square

CONT : 6  
VOL : 0.029

Note : Height 286 MM Uses C-5701

51

**C-7921** Oil Filter Full Flow Spin-On



PERKINS 140 516 130  
SAAB-SCANIA 173171  
KUBOTA 1C010-32430

H 1 : 92 (mm)  
OD 1 : 93 (mm)  
Thread Size : 3/4-16 UNF-2B  
BPV (kg/cm<sup>2</sup>) : 1.0  
ADBV : YES  
Gasket Type : Square

CONT : 12  
VOL : 0.016

Note : With HAT/CAP

56

**C-5704** Oil Filter Full Flow Spin-On Cellulose media



J.C.BAMFORD 02/910140  
J.C.BAMFORD 02/910140A  
CUMMINS 3903264  
LIUGONG 53C0226

H 1 : 172 (mm)  
OD 1 : 93 (mm)  
Thread Size : 1-16 UNF-2B  
Gasket Type : Square

CONT : 12  
VOL : 0.023

Note : High Performance Grade Uses C-5730

47

**C-5718** Oil Filter By Pass Spin-On



ISUZU 1-87310093-0  
CATERPILLAR 1W-8845  
J.C.BAMFORD 32/919502  
HITACHI 4285964  
LIUGONG 53C0499

H 1 : 246.5 (mm)  
OD 1 : 115 (mm)  
Thread Size : 1 3/8-16 UN-2B  
Gasket Type : Square

CONT : 6  
VOL : 0.032

52

**C-7926** Oil Filter Full Flow Spin-On



KUBOTA 16414-32432  
KUBOTA 17321-32430

H 1 : 84.6 (mm)  
OD 1 : 93 (mm)  
Thread Size : 3/4-16 UNF-2B  
BPV (kg/cm<sup>2</sup>) : 2.0 - 2.5  
ADBV : YES  
Gasket Type : Round

CONT : 12  
VOL : 0.014

57

**C-5707** Oil Filter Combination Spin-On Seamless



J.C.BAMFORD 02/910965  
CUMMINS 3401544  
FOTON 3401544F  
KOMATSU 6742-01-4540

H 1 : 294 (mm)  
OD 1 : 118 (mm)  
Thread Size : 2 1/4-12 UNF-2B  
Gasket Type : Square

CONT : 6  
VOL : 0.029

Note : Multilayer

48

**C-5723** Oil Filter Combination Spin-On Synthetic Media



KOMATSU 6742-01-4120

H 1 : 280 (mm)  
OD 1 : 121 (mm)  
Thread Size : 2 1/4-12 UNF-2B  
Gasket Type : Square

CONT : 6  
VOL : 0.038

Note : C-5723 is upgrade version of C-5706

53

**C-8012** Oil Filter Full Flow Spin-On



MAHINDRA 14501673990  
HITACHI 26300-21010  
HYUNDAI 26300-21010  
CHRYSLER 4186267  
MITSUBISHI 4253037

H 1 : 78 (mm)  
OD 1 : 86 (mm)  
Thread Size : M20X1.5-6H  
BPV (kg/cm<sup>2</sup>) : 1.0  
ADBV : YES  
Gasket Type : Square

CONT : 36  
VOL : 0.036

58

**C-5708** Oil Filter Full Flow Spin-On Cellulose media



J.C.BAMFORD 32/925413  
CUMMINS 3937736  
LIUGONG SP105056

H 1 : 174 (mm)  
OD 1 : 93 (mm)  
Thread Size : 1 1/8-16 UNF-2B  
Gasket Type : Square

CONT : 12  
VOL : 0.027

Note : Glass Fiber media uses C-5733

49

**C-5811** Oil Filter Full Flow Spin-On



MITSUBISHI 32A40-00100  
MITSUBISHI 32A40-00101  
MITSUBISHI 32A40-00400

H 1 : 100 (mm)  
OD 1 : 102 (mm)  
Thread Size : 1-12 UNF-2B  
BPV (kg/cm<sup>2</sup>) : 1.0  
ADBV : YES  
Gasket Type : Square

CONT : 12  
VOL : 0.021

54

**CA-28181** Cabin Air Filter Plastic framed Element



HYUNDAI 11Q6-90510

H 1 : 20 (mm)  
Length 1 : 209.5 (mm)  
Width 1 : 117.5 (mm)

CONT : 20  
VOL : 0.031

59

**C-5714** Oil Filter Full Flow Spin-On long life



CUMMINS 3934430  
CASE J934430

H 1 : 174 (mm)  
OD 1 : 93 (mm)  
Thread Size : 1-16 UNF-2B  
Gasket Type : Square

CONT : 20  
VOL : 0.055

50

**C-6202** Oil Filter Full Flow Spin-On



WUXI DIESEL 1012010-29D  
DEMAG 206 089 40  
RENAULT 60 05 024 443

H 1 : 140 (mm)  
OD 1 : 93 (mm)  
Thread Size : 1-12 UNF-2B  
BPV (kg/cm<sup>2</sup>) : 1.0  
Gasket Type : Square

CONT : 25  
VOL : 0.041

Note : Without Nut

55

**CA-28230** Cabin Air Filter Plastic framed Element



HYUNDAI 71LB-00290

H 1 : 35 (mm)  
H 2 : 25 (mm)  
Length 1 : 295 (mm)  
Width 1 : 195 (mm)

CONT : 20  
VOL : 0.056

Note : for Hyundai Loader HL757-7 1998, Hyundai Wheel Loader HL 730-7

60

**CA-28240** Cabin Air Filter Plastic framed Element  
HYUNDAI 11N6-90760



H 1 : 20 (mm)  
Length 1 : 230 (mm)  
Length 2 : 243.5 (mm)  
Width 1 : 107 (mm)  
Width 2 : 107 (mm)

CONT : 20  
VOL : 0.026

61

**CA-28360** Cabin Air Filter Plastic framed Element  
ZOOMLION 1010500127  
HYUNDAI 11N6-90770



H 1 : 15.5 (mm)  
Length 1 : 199 (mm)  
Width 1 : 178.5 (mm)

CONT : 20  
VOL : 0.043

Note : Hyundai Excavator model: R200

62

**CA-28410** Cabin Air Filter Paper framed Element  
HYUNDAI 11MH-90330  
NEW HOLLAND (CNH) 11MH-90330



H 1 : 40 (mm)  
Length 1 : 157 (mm)  
Width 1 : 79 (mm)

CONT : 20  
VOL : 0.025

63

**F-28460** Fuel Filter Plastic body In-Tank  
HYUNDAI XJAU-00956



H 1 : 117 (mm)  
OD 1 : 52.5 (mm)  
ID 1 : 20 (mm)

CONT : 50  
VOL : 0.026

64

**FC-1007** Fuel Filter Spin-On  
CATERPILLAR 103-2901  
TOYOTA 233203391071



H 1 : 100 (mm)  
H 2 : 100 (mm)  
OD 1 : 80 (mm)  
Thread Size : M20X1.5-6H  
Gasket Type : Round

CONT : 50  
VOL : 0.041

65

**FC-1010** Fuel Filter Spin-On  
MITSUBISHI ME035829



H 1 : 125 (mm)  
OD 1 : 90 (mm)  
Thread Size : M20X1.5-6H  
Gasket Type : Square

CONT : 36  
VOL : 0.048

66

**FC-1016** Fuel Filter Spin-On  
LOESING 025122  
MITSUBISHI ME 006066



H 1 : 80 (mm)  
OD 1 : 90 (mm)  
Thread Size : M20X1.5-6H  
Gasket Type : Square

CONT : 36  
VOL : 0.032

67

**FC-1804** Fuel Filter Spin-On High Efficiency  
NISSAN 16403-01T01  
NISSAN 16403-Z9000  
NISSAN 16403-Z9005  
SDLG 4110001091001



H 1 : 114.5 (mm)  
OD 1 : 80 (mm)  
Thread Size : 3/4-16 UNF-2B  
Gasket Type : Round

CONT : 50  
VOL : 0.050

68

**FC-28030** Fuel Filter Primary Spin-On  
HYUNDAI 31945-84000



Secondary Filter uses FC-28040  
Set Filter uses FC-28200-S  
H 1 : 169 (mm)  
OD 1 : 96 (mm)  
Thread Size : M22X1.5-6H  
Gasket Type : Square

CONT : 12  
VOL : 0.026

69

**FC-28040** Fuel Filter Secondary Spin-On High Efficiency  
HYUNDAI 31945-84040



Primary Filter uses FC-28030  
Set Filter uses FC-28200-S  
H 1 : 169 (mm)  
OD 1 : 96 (mm)  
Thread Size : M22X1.5-6H  
Gasket Type : Square

CONT : 12  
VOL : 0.026

70

**FC-28200-S** Fuel Filter Set Spin-On  
HYUNDAI 31945-84000+31945-84040



Primary Filter uses FC-28030  
Secondary Filter uses FC-28040  
H 1 : 169 (mm)  
OD 1 : 96 (mm)  
Thread Size : M22X1.5-6H  
Gasket Type : Square

CONT : 12  
VOL : 0.046

Note : FC-28030+FC-28040

71

**FC-45010** Fuel Filter Spin-On  
WEICHAH 612600081334  
NEW HOLLAND (CNH) 87803197  
CASE 87803200



H 1 : 180 (mm)  
OD 1 : 93 (mm)  
Thread Size : M20X1.5-6H  
Gasket Type : Square

CONT : 12  
VOL : 0.025

72

**FC-5602** Fuel Filter Spin-On  
ISUZU 1-13240044-0  
KOMATSU 600-311-8291  
ISUZU X1.3240021



H 1 : 175 (mm)  
OD 1 : 93 (mm)  
Thread Size : 1-14 UNS-2B  
Gasket Type : Round

CONT : 12  
VOL : 0.026

73

**FC-5702** Fuel Filter Spin-On  
MITSUBISHI 32540-20300  
MITSUBISHI 32562-20300  
HITACHI 4085912



H 1 : 175 (mm)  
OD 1 : 93 (mm)  
Thread Size : 1-14 UNS-2B  
Thread Nut Size : M8X1.25  
Gasket Type : Square

CONT : 12  
VOL : 0.030

74

**FC-5720** Fuel Filter Spin-On  
CUMMINS 154709  
CUMMINS 3315844



H 1 : 135 (mm)  
OD 1 : 93 (mm)  
Thread Size : 1-14 UNS-2B  
Gasket Type : Square

CONT : 12  
VOL : 0.021

Note : Is a short version of FC-57270

75



**FC-5725** Fuel Filter Spin-On Synthetic Media

DAF 1399760  
IVECO 2992241  
CUMMINS 4897833



H 1 : 191 (mm)  
OD 1 : 93 (mm)  
Thread Size : M20X1.5-6H  
Gasket Type : Square

CONT : 12  
VOL : 0.030

76

**H-28100** Hydraulic Oil Filter Suction Aluminium casting end cap, Element

HYUNDAI 31MH-01210



H 1 : 155 (mm)  
H 2 : 133 (mm)  
OD 1 : 100 (mm)  
OD 2 : 95 (mm)  
Thread Size : 1 1/2-11 BSPT

CONT : 25  
VOL : 0.045

Note : Crawler Excavators R35Z-7A

81

**HC-5503** Hydraulic Oil Filter Spin-On Synthetic Media

CATERPILLAR 1081153  
INGERSOLL RAND 51302214  
VOLVO BM 9658998



H 1 : 293 (mm)  
OD 1 : 122 (mm)  
Thread Size : 1 3/4-12 UNF-2B

CONT : 6  
VOL : 0.032

Note : with Glass Fiber media

86

**FC-7903** Fuel Filter Secondary Spin-On High Efficiency

J.C.BAMFORD 02/910155  
CUMMINS 3903640  
CUMMINS 3931063  
DONGFENG C39310663



H 1 : 115 (mm)  
OD 1 : 76 (mm)  
Thread Size : M16X1.5-6H  
Gasket Type : Square

CONT : 25  
VOL : 0.023

Note : High efficiency

77

**H-5609** Hydraulic Oil Filter Metal End Cap Element Cellulose media

LOESING 025053  
KOMATSU 07063-01142  
KOMATSU 07063-01412  
KOMATSU 195-60-16320



H 1 : 300.5 (mm)  
OD 1 : 150 (mm)  
OD 2 : 150 (mm)  
ID 1 : 110 (mm)  
ID 2 : 110 (mm)

CONT : 6  
VOL : 0.059

82

**HC-6802** Hydraulic Oil Filter Spin-On

LOESING 025105  
MASSEY-FERGUSON 2979653M1  
VOLVO 4787923  
INGERSOLL RAND 54672654



H 1 : 200 (mm)  
OD 1 : 93 (mm)  
Thread Size : 1-12 UNF-2B  
BPV (kg/cm2) : YES  
Gasket Type : Square

CONT : 12  
VOL : 0.034

87

**H-2719** Hydraulic Oil Filter Metal End Cap Element Cellulose media

HYUNDAI 31E3-0018  
HITACHI 4294135  
YAMASHIN DT-04-10-10



H 1 : 87 (mm)  
H 2 : 83.5 (mm)  
OD 1 : 42.5 (mm)  
OD 2 : 42.5 (mm)  
ID 1 : 21.5 (mm)

CONT : 50  
VOL : 0.011

Note : Wiremesh type uses H-5211

78

**H-7930** Hydraulic Oil Filter Wire Mesh supported Element

HYUNDAI 31M5-70020



H 1 : 166.5 (mm)  
H 2 : 158 (mm)  
OD 1 : 124 (mm)  
OD 2 : 124 (mm)  
ID 1 : 59.5 (mm)  
Thread Size : M10X1.5-6H

CONT : 20  
VOL : 0.074

83

**HC-76130** Hydraulic Oil Filter Transmission Spin-On With Microfiber media

ZF 0501323154  
J.C.BAMFORD 32925905  
CASE 8603535  
CASE 87519452  
JOHN DEERE AT336140



H 1 : 199 (mm)  
OD 1 : 94.5 (mm)  
Thread Size : 1 3/8-12 UNF-2B  
Thread Stud Size : M24X1.5

CONT : 12  
VOL : 0.024

88

**H-2725** Hydraulic Oil Filter Metal End Cap Element

HYUNDAI E131-0212  
HYUNDAI E131-0212-4



H 1 : 455 (mm)  
H 2 : 450 (mm)  
OD 1 : 150 (mm)  
OD 2 : 150 (mm)  
ID 1 : 85 (mm)  
ID 2 : 85 (mm)

CONT : 6  
VOL : 0.080

79

**HC-2701** Hydraulic Oil Filter Transmission Spin-On

LIUGONG 0750131053ZE  
HITACHI 4230376  
HITACHI 4286837  
KOMATSU BW252116



H 1 : 200 (mm)  
OD 1 : 93 (mm)  
Thread Size : 1-12 UNF-2B  
Thread Nut Size : M24X1.5  
BPV (kg/cm2) : 2.5  
Gasket Type : Square

CONT : 12  
VOL : 0.036

84

**HC-7940** Hydraulic Oil Filter Spin-On

SDLG 11211213  
CASE 150794A1



H 1 : 136 (mm)  
OD 1 : 93 (mm)  
Thread Size : 1 1/8-16 UNF-2B  
Gasket Type : Square

CONT : 12  
VOL : 0.022

89

**H-28040** Hydraulic Oil Filter Metal End Cap Element Cellulose media

HYUNDAI 31E9-1019



H 1 : 355.4 (mm)  
H 2 : 350 (mm)  
OD 1 : 150 (mm)  
OD 2 : 150 (mm)  
ID 1 : 85 (mm)  
ID 2 : 85 (mm)

CONT : 4  
VOL : 0.045

Note : for Hyundai Excavator MB-P90

80

**HC-28130** Hydraulic Oil Filter Spin-On

HYUNDAI 31N8-01360



H 1 : 130 (mm)  
OD 1 : 93 (mm)  
Thread Size : 1 1/8-16 UNF-2B  
Gasket Type : Round

CONT : 50  
VOL : 0.073

85

**O-1006** Oil Filter Combination Metal End Cap Element

KOBELCO 2451U1721A  
HYUNDAI 26316-93000  
MITSUBISHI ME 034605



H 1 : 192 (mm)  
H 2 : 191 (mm)  
OD 1 : 110 (mm)  
OD 2 : 100 (mm)  
ID 1 : 33 (mm)  
ID 2 : 19 (mm)

CONT : 25  
VOL : 0.075

Note : Paper Protector

90

# Sakura Filter

# Technical Specification

**O-1010** Oil Filter Full Flow Metal End Cap Element

MITSUBISHI 31240-53053  
MITSUBISHI 31240-53054



H 1 : 148,4 (mm)  
H 2 : 142 (mm)  
OD 1 : 128 (mm)  
OD 2 : 128 (mm)  
ID 1 : 58 (mm)  
ID 2 : 58 (mm)

CONT : 16  
VOL : 0.049

91

**SFC-5702-10** Fuel/Water Separator Spin-On 10 Micron

CUMMINS 3800394  
CASE J800394



H 1 : 211 (mm)  
OD 1 : 94 (mm)  
Thread Size : 1-14 UNS-2B  
Gasket Type : Square

CONT : 12  
VOL : 0.036

96

**SFC-5711** Fuel/Water Separator Spin-On

CUMMINS 3973233  
CASE 87356193  
NEW HOLLAND (CNH) 87356194  
SANY B222100000444



H 1 : 164 (mm)  
OD 1 : 93 (mm)  
Thread Size : 1-14 UNS-2B  
Gasket Type : Square

CONT : 12  
VOL : 0.030

101

**SFC-1905-10** Fuel/Water Separator Secondary Spin-On 10 Micron

MASSEY-FERGUSON 108615W1  
BOMAG 31701062  
LIEBHERR 7364111  
SANY A222100000399  
KOBELCO YN02PU1010P1



H 1 : 156 (mm)  
OD 1 : 95 (mm)  
Thread Size : 1-14 UNS-2B  
Thread Nut Size : 1 1/4-10 UNS-2B  
Gasket Type : Square

CONT : 12  
VOL : 0.026

Note : bowl not included

92

**SFC-5705** Fuel/Water Separator Spin-On

ISUZU 1-13240044-1  
CUMMINS 3308638  
CUMMINS 3315843  
SUNWARD 750201011130



H 1 : 174 (mm)  
OD 1 : 93 (mm)  
Thread Size : 1-14 UNS-2B  
Thread Size : M14X2.0  
Gasket Type : Square

CONT : 12  
VOL : 0.026

97

**SFC-7912-30** Fuel/Water Separator Primary Spin-On 30 Micron

HYUNDAI 11LB-20310  
SAAB-SCANIA 1393640  
ATLAS COPCO 2914807000  
VOLVO 8159975  
SANY A222100000207



Secondary Filter uses SFC-7912-10  
Final Filter uses SFC-7912-02

H 1 : 155 (mm)  
OD 1 : 108 (mm)  
Thread Size : 1-14 UNS-2B  
Thread Nut Size : 3 3/4-10 UNS-2A  
Gasket Type : Square

CONT : 12  
VOL : 0.033

Note : for 300RC series,400 series,600 series,700 series

102

**SFC-28080** Fuel/Water Separator Spin-On With Drain

HYUNDAI 11ND-70010



H 1 : 286 (mm)  
H 2 : 257 (mm)  
OD 1 : 118 (mm)  
Thread Size : M85X2  
ADBV : YES  
Gasket Type : Round

CONT : 6  
VOL : 0.034

93

**SFC-5706** Fuel/Water Separator Spin-On

J.C.BAMFORD 02/910150  
J.C.BAMFORD 02/910150A  
HYUNDAI 11E1-70210  
CUMMINS 3935274  
LIUGONG 53C0051



H 1 : 134 (mm)  
OD 1 : 93 (mm)  
Thread Size : 13/16-18 UNS-2B  
Thread Nut Size : M14X2  
Gasket Type : Square

CONT : 12  
VOL : 0.021

98

**WC-5703** Coolant Filter Spin-On

CUMMINS 3318319  
HITACHI 4266063  
KOMATSU 6742-01-3490



H 1 : 136 (mm)  
OD 1 : 93 (mm)  
Thread Size : 11/16-16 UNF-2B  
Gasket Type : Square

CONT : 12  
VOL : 0.018

Note : Coolants 23 units

103

**SFC-5509-10** Fuel/Water Separator Spin-On With Drain and Sensor Port 10 Micron

CUMMINS 3406889  
CUMMINS 3954891  
CUMMINS 3954904  
CUMMINS 4070801  
SANY B222100000462



H 1 : 211 (mm)  
OD 1 : 93 (mm)  
Thread Size : 1-14 UNS-2B  
Gasket Type : Square

CONT : 12  
VOL : 0.036

94

**SFC-5708** Fuel/Water Separator Spin-On

CUMMINS 3286503  
CUMMINS 3843760  
CUMMINS 3903202



H 1 : 140 (mm)  
OD 1 : 76 (mm)  
Thread Size : M16X1.5-6H  
Gasket Type : Square

CONT : 25  
VOL : 0.033

99

**WC-5705** Coolant Filter Spin-On

CUMMINS 299080  
CUMMINS 3100304  
CUMMINS 3305367



H 1 : 100 (mm)  
OD 1 : 93 (mm)  
Thread Size : 11/16-16 UNF-2B  
Gasket Type : Square

CONT : 12  
VOL : 0.018

Note : Coolants 4 units

104

**SFC-55200** Fuel/Water Separator Spin-On

CUMMINS 3991498  
LIUGONG SP105053



H 1 : 192 (mm)  
OD 1 : 93 (mm)  
Thread Size : M20X1.5-6H  
Gasket Type : Square

CONT : 12  
VOL : 0.026

95

**SFC-5709-10** Fuel/Water Separator Spin-On 10 Micron

CATERPILLAR 256-8753  
CUMMINS 3329289  
HITACHI 4377880  
SANY B222100000596



H 1 : 245 (mm)  
OD 1 : 93 (mm)  
Thread Size : 1-14 UNS-2B  
Gasket Type : Square

CONT : 6  
VOL : 0.019

100

**WC-5711** Coolant Filter Spin-On

CUMMINS 3315115  
CUMMINS 3316462  
CUMMINS 4058964



H 1 : 100 (mm)  
OD 1 : 93 (mm)  
Thread Size : 11/16-16 UNF-2B  
Gasket Type : Square

CONT : 12  
VOL : 0.014

Note : Coolants 8 units

105

**WC-5712**

Coolant Filter Spin-On

CUMMINS 3100307  
 CUMMINS 3315114  
 CUMMINS 3316053



H 1 : 135 (mm)  
 OD 1 : 93 (mm)  
 Thread Size : 11/16-16 UNF-2B  
 Gasket Type : Square

CONT : 12  
 VOL : 0.020

Note : Coolants 12 units

106

**WC-5713**

Coolant Filter Spin-On

HITACHI 4228689  
 INGERSOLL RAND 57165805



H 1 : 136 (mm)  
 OD 1 : 93 (mm)  
 Thread Size : 11/16-16 UNF-2B  
 Gasket Type : Square

CONT : 12  
 VOL : 0.022

Note : Coolants 15 units

107

**SAMSUNG**

**4**



# Engine Application

A

MODEL/APPLICATION	SAKURA NO	MODEL/APPLICATION	SAKURA NO
<b>SAMSUNG</b>		<b>SAMSUNG</b>	
<b>LC240</b> (EXCAVATORS)  Hydraulic Oil Filter..... HC-8805		<b>SL120-2</b> (EXCAVATORS) CUMMINS 6BT5.9 Air Filter Secondary..... A-6008 Air Filter Primary..... A-2210 Fuel Filter Secondary..... FC-7903 Oil Filter Full Flow..... C-5704	
<b>SE130LC</b> (EXCAVATORS) CUMMINS 4BT3.9 , 1991 Fuel Filter Secondary..... FC-7903 Fuel/Water Separator..... SFC-5706 Oil Filter Full Flow..... C-5703		<b>SL150</b> (EXCAVATORS) CUMMINS 6BT5.9 Air Filter Secondary..... A-6008 Air Filter Primary..... A-2210 Fuel Filter Secondary..... FC-7903 Fuel/Water Separator..... SFC-5706 Hydraulic Oil Filter Transmission... HC-2701 Oil Filter Combination..... C-5723	
<b>SE210LC</b> (EXCAVATORS) CUMMINS 6BT5.9 , 1991 Air Filter Primary..... A-2210 Air Filter Secondary..... A-6008 Fuel Filter Secondary..... FC-7903 Fuel/Water Separator..... SFC-5706 Oil Filter Full Flow..... C-5704		<b>SL180</b> (EXCAVATORS) CUMMINS 6CT8.3 Air Filter Secondary..... A-6008 Air Filter Primary..... A-2210 Coolant Filter..... WC-5705 Fuel Filter Secondary..... FC-7903 Fuel/Water Separator..... SFC-5706 Oil Filter Combination..... C-5723	
<b>SE210LC-3</b> (EXCAVATORS)  Air Filter Secondary..... A-6008			
<b>SE250</b> (EXCAVATORS) CUMMINS LTA10 Air Filter..... A-22320 Air Filter Secondary..... A-2207 Fuel/Water Separator..... SFC-5705 Oil Filter Combination..... C-5723			
<b>SE280</b> (EXCAVATORS) CUMMINS 6CT8.3 , 1991 Coolant Filter..... WC-5711 Fuel Filter Secondary..... FC-7903 Fuel/Water Separator..... SFC-5706 Oil Filter Combination..... C-5723			
<b>SE280LC2</b> (EXCAVATORS)  Air Filter Secondary..... A-6008 Coolant Filter..... WC-5705 Fuel Filter Secondary..... FC-7903 Fuel/Water Separator..... SFC-5706 Hydraulic Oil Filter..... H-2719 Hydraulic Oil Filter..... HC-8805 Oil Filter Combination..... C-5723			
<b>SE240LC-3</b> (EXCAVATORS) CUMMINS C8.3-C Hydraulic Oil Filter..... H-2728			
<b>SE350LC2</b> (EXCAVATORS) CUMMINS LTA10 Air Filter Set..... A-2209-S Air Filter Primary..... A-2209 Coolant Filter..... WC-5711 Fuel/Water Separator..... SFC-5705 Hydraulic Oil Filter..... H-2709 Oil Filter Combination..... C-5723			
<b>SF25D</b> (EXCAVATORS) YANMAR 4TNE94 Air Filter Primary..... AS-5620 Fuel Filter..... FC-1016 Oil Filter Full Flow..... C-8012			

# Technical Specification

**B**

# Sakura Filter

# Technical Specification

**A-2207** Air Filter Secondary Metal End Cap Element



ORENSTEIN & KOPPEL 1433799  
CATERPILLAR 3I-0191  
FORD 703408  
FIAT 70671839

Primary Filter uses A-2209  
Set Filter uses A-2209-S

H 1 : 546 (mm)  
H 2 : 533 (mm)  
OD 1 : 194 (mm)  
OD 2 : 194 (mm)  
ID 1 : 153 (mm)  
ID 2 : 23 (mm)

CONT : 9  
VOL : 0.221

Note : Is a Secondary Air filter for A-2209,A-22320

**A-6008** Air Filter Secondary Metal End Cap Element



LOESING 020940  
ISUZU 1-14215047-0  
ISUZU 1-1425-046-1  
NISSAN 16546-96010

Primary Filter uses A-5627  
Set Filter uses A-5663-S

H 1 : 330 (mm)  
OD 1 : 146 (mm)  
OD 2 : 116.5 (mm)  
ID 1 : 88 (mm)  
ID 2 : 17 (mm)

CONT : 9  
VOL : 0.083

**C-8012** Oil Filter Full Flow Spin-On



MAHINDRA 14501673990  
HITACHI 26300-21010  
HYUNDAI 26300-21010  
CHRYSLER 4186267  
MITSUBISHI 4253037

H 1 : 78 (mm)  
OD 1 : 86 (mm)  
Thread Size : M20X1.5-6H  
BPV (kg/cm<sup>2</sup>) : 1.0  
ADBV : YES  
Gasket Type : Square

CONT : 36  
VOL : 0.036

**A-2209** Air Filter Primary Metal End Cap Element



FIAT 70671838

Secondary Filter uses A-2207  
Set Filter uses A-2209-S

H 1 : 597 (mm)  
H 2 : 584 (mm)  
OD 1 : 307 (mm)  
OD 2 : 307 (mm)  
ID 1 : 196 (mm)  
ID 2 : 23 (mm)

CONT : 1  
VOL : 0.075

**AS-5620** Air Filter Primary Metal End Cap Element With Sleeve



KOMATSU 600-181-7300

Secondary Filter uses A-5621  
Set Filter uses AS-5620-S

H 1 : 290 (mm)  
H 2 : 280.5 (mm)  
OD 1 : 160 (mm)  
OD 2 : 134 (mm)  
ID 1 : 87 (mm)  
ID 2 : 17 (mm)

CONT : 9  
VOL : 0.090

**FC-1016** Fuel Filter Spin-On



LOESING 025122  
MITSUBISHI ME 006066

H 1 : 80 (mm)  
OD 1 : 90 (mm)  
Thread Size : M20X1.5-6H  
Gasket Type : Square

CONT : 36  
VOL : 0.032

**A-2209-S** Air Filter Set Metal End Cap Element



FIAT 70671838+70671839

Primary Filter uses A-2209  
Secondary Filter uses A-2207

H 1 : 597 (mm)  
H 2 : 584 (mm)  
OD 1 : 307 (mm)  
OD 2 : 307 (mm)  
ID 1 : 196 (mm)  
ID 2 : 23 (mm)

CONT : 1  
VOL : 0.075

**C-5703** Oil Filter Full Flow Spin-On



HYUNDAI 11E1-70110  
CUMMINS 3903224  
LIUGONG 40C0677  
KOMATSU 6732-51-5140  
CASE J908616

H 1 : 135 (mm)  
OD 1 : 93 (mm)  
Thread Size : 1-16 UNF-2B  
Gasket Type : Square

CONT : 12  
VOL : 0.018

**FC-7903** Fuel Filter Secondary Spin-On High Efficiency



J.C.BAMFORD 02/910155  
CUMMINS 3903640  
CUMMINS 3931063  
DONGFENG C39310663

H 1 : 115 (mm)  
OD 1 : 76 (mm)  
Thread Size : M16X1.5-6H  
Gasket Type : Square

CONT : 25  
VOL : 0.023

Note : High efficiency

**A-2210** Air Filter Primary Metal End Cap Element



FIAT 0068473-3  
LOESING 021779  
ISUZU 1-14215-018-0  
ISUZU 1-14215007-0  
NISSAN 16546-96011

Secondary Filter uses A-6008  
Set Filter uses A-6117-S

H 1 : 342.7 (mm)  
H 2 : 330 (mm)  
OD 1 : 234 (mm)  
OD 2 : 234 (mm)  
ID 1 : 123 (mm)  
ID 2 : 17 (mm)

CONT : 4  
VOL : 0.093

**C-5704** Oil Filter Full Flow Spin-On Cellulose media



J.C.BAMFORD 02/910140  
J.C.BAMFORD 02/910140A  
CUMMINS 3903264  
LIUGONG 53C0226

H 1 : 172 (mm)  
OD 1 : 93 (mm)  
Thread Size : 1-16 UNF-2B  
Gasket Type : Square

CONT : 12  
VOL : 0.023

Note : High Performance Grade Uses C-5730

**H-2709** Hydraulic Oil Filter Metal End Cap Element



KOMATSU 07063-01383  
KOMATSU 208-60-61150  
HITACHI 4287634  
HITACHI 76580323

H 1 : 450 (mm)  
OD 1 : 180 (mm)  
OD 2 : 180 (mm)  
ID 1 : 110 (mm)  
ID 2 : 110 (mm)

CONT : 9  
VOL : 0.173

**A-22320** Air Filter Metal End Cap Element



ORENSTEIN & KOPPEL 1433798  
TEREX 1433798  
FORD 703409  
FIAT-ALLIS 70671838

H 1 : 600 (mm)  
H 2 : 587 (mm)  
OD 1 : 307 (mm)  
OD 2 : 307 (mm)  
ID 1 : 196 (mm)  
ID 2 : 23 (mm)

CONT : 1  
VOL : 0.073

Note : Is a long life version of A-2209

**C-5723** Oil Filter Combination Spin-On Synthetic Media



KOMATSU 6742-01-4120

H 1 : 280 (mm)  
OD 1 : 121 (mm)  
Thread Size : 2 1/4-12 UNF-2B  
Gasket Type : Square

CONT : 6  
VOL : 0.038

Note : C-5723 is upgrade version of C-5706

**H-2719** Hydraulic Oil Filter Metal End Cap Element Cellulose media



HYUNDAI 31E3-0018  
HITACHI 4294135  
YAMASHIN DT-04-10-10

H 1 : 87 (mm)  
H 2 : 83.5 (mm)  
OD 1 : 42.5 (mm)  
OD 2 : 42.5 (mm)  
ID 1 : 21.5 (mm)

CONT : 50  
VOL : 0.011

Note : Wiremesh type uses H-5211



**H-2728** Hydraulic Oil Filter Metal End Cap Element

SAMSUNG 1141-00040  
KOBELCO YN50V00001P1



H 1 : 452.5 (mm)  
H 2 : 450 (mm)  
OD 1 : 150 (mm)  
OD 2 : 150 (mm)  
ID 1 : 110 (mm)  
ID 2 : 110 (mm)

CONT : 10  
VOL : 0.133

16

**WC-5705** Coolant Filter Spin-On

CUMMINS 299080  
CUMMINS 3100304  
CUMMINS 3305367



H 1 : 100 (mm)  
OD 1 : 93 (mm)  
Thread Size : 11/16-16 UNF-2B  
Gasket Type : Square

CONT : 12  
VOL : 0.018

Note : Coolants 4 units

21

**HC-2701** Hydraulic Oil Filter Transmission Spin-On

LIUGONG 0750131053ZE  
HITACHI 4230376  
HITACHI 4286837  
KOMATSU BW252116



H 1 : 200 (mm)  
OD 1 : 93 (mm)  
Thread Size : 1-12 UNF-2B  
Thread Nut Size : M24X1.5  
BPV (kg/cm2) : 2.5  
Gasket Type : Square

CONT : 12  
VOL : 0.036

17

**WC-5711** Coolant Filter Spin-On

CUMMINS 3315115  
CUMMINS 3316462  
CUMMINS 4058964



H 1 : 100 (mm)  
OD 1 : 93 (mm)  
Thread Size : 11/16-16 UNF-2B  
Gasket Type : Square

CONT : 12  
VOL : 0.014

Note : Coolants 8 units

22

**HC-8805** Hydraulic Oil Filter Spin-On

INTERPARTS KNJ0288



H 1 : 136 (mm)  
OD 1 : 93 (mm)  
Thread Size : 1 1/8-16 UNS-2B  
Gasket Type : Square

CONT : 12  
VOL : 0.022

18

**SFC-5705** Fuel/Water Separator Spin-On

ISUZU 1-13240044-1  
CUMMINS 3308638  
CUMMINS 3315843  
SUNWARD 750201011130



H 1 : 174 (mm)  
OD 1 : 93 (mm)  
Thread Size : 1-14 UNS-2B  
Thread Size : M14X2.0  
Gasket Type : Square

CONT : 12  
VOL : 0.026

19

**SFC-5706** Fuel/Water Separator Spin-On

J.C.BAMFORD 02/910150  
J.C.BAMFORD 02/910150A  
HYUNDAI 11E1-70210  
CUMMINS 3935274  
LIUGONG 53C0051



H 1 : 134 (mm)  
OD 1 : 93 (mm)  
Thread Size : 13/16-18 UNS-2B  
Thread Nut Size : M14X2  
Gasket Type : Square

CONT : 12  
VOL : 0.021

20